

RETROAIRE™

The Right Fit for Comfort

R80C/H

Packaged Terminal Air Conditioner (PTAC)

Packaged Terminal Heat Pump (PTHP)

Straight cooling nominal capacities

9,000	12,000	15,000	18,000	Btuh
2.6	3.5	4.4	5.3	kW

Heat pump nominal capacities

9,000	12,000	15,000	Btuh
2.6	3.5	4.4	kW

Specifications and Performance

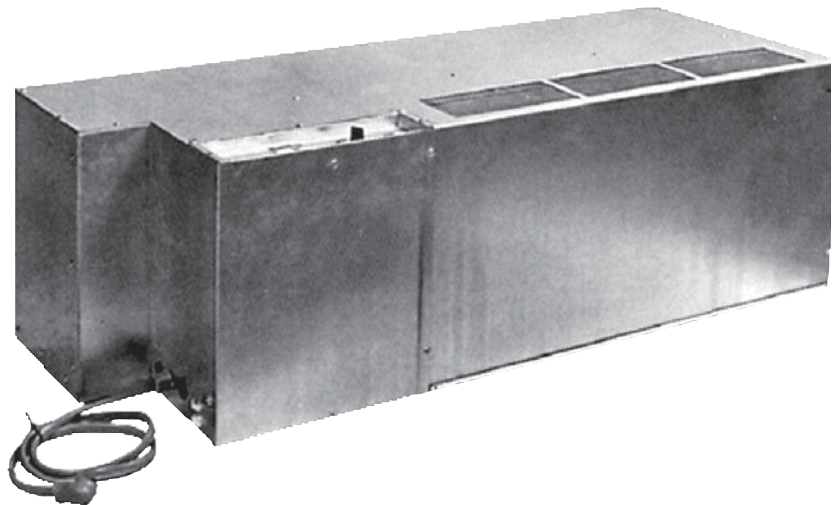

ECR International Inc
2201 Dwyer Avenue
Utica, NY 13501
e-mail: info@RetroAire.com



An ISO 9001-2008 Certified Company

R80C | R80H

Replacement for:
Fedders CMEO "Unizone",
Mueller/Worthington "Climatrol"

TABLE OF CONTENTS

General Product Information	3-5
Product Description	3
Standard Controls And Components	3
Factory-Installed Options (Consult The Factory)	4
Field-Installed Accessories	4
R10C/R10H Chassis	5
PTAC/PTHP Model Nomenclature	6
Field Installed Accessories	6
Features	7-8
Optional Wall-Mounted Thermostats	8
Sequence of Operation	9-11
Initial Power-Up Or Power Restoration	9
R_ _C / R_ _H: Cooling Operation	9-10
R_ _C / R_ _H: Heating Operation	10
R_ _H: Mechanical Heating "Heat Pump"	10
R_ _H: Auxiliary Heating "Electric" or "Hydronic"	10-11
Performance Data	12
Electrical Specifications	13-15

NOTICE
<p>RetroAire™ replacement PTAC/PTHP is backed by EMI and ECR International and is tested and rated in accordance with: AHRI Standards 310/380 UL-484</p>



Information and specifications outlined in this manual in effect at the time of printing of this manual. ECR International reserves the right to discontinue, change specifications or system design at any time without notice and without incurring any obligation, whatsoever.

GENERAL PRODUCT INFORMATION

Product Description

- RetroAire Replacement Packaged Terminal Air Condition/Heat Pumps units are available in straight cooling (PTAC) or as heat pump systems (PTHP).
- Both PTAC and PTHP configurations fit wall sleeves of units listed on front cover.
- Heat pumps (PHTP) reduce energy costs and will operate in mechanical heat mode down to outdoor temperature of 40°F (4.4°C), Below 40°F (4.4°C) heating is accomplished by auxillary heat option.

RetroAire PTAC/PHTP units:

- Use R-410A refrigerant. Refrigerant is not affected by phase out schedule.
- Include high-efficiency rotary compressors, protected by 5-year warranty.
- Include enhanced, high-efficiency heat exchangers.
- Offer two fan speeds.
- Incorporate positive condensate re-evaporation to improve efficiency.
- Have optional motorized fresh-air feature with positive pressure seal.

RetroAire PTAC/PHTP ratings meet or exceed ASHRAE 90.1 Standards for energy efficiency:

- PTAC/PHTP units are available in nominal sizes of 9,000 Btuh, (2.6kW) 12,000 Btuh (3.5kW) or 15,000 Btuh (4.4kW).
- PTAC units (straight cooling only) are also available at 18,000 Btuh (5.3kW).
- Energy Efficiency Rating (EER) as high as 10.
- Coefficient of performance (COP) ratings as high as 2.90 for heat pumps.

Standard Controls And Components

Construction

- 20-gauge galvanized steel construction of chassis.
- Condenser baffle options to accommodate extended wall sleeve applications. (Consult the factory for special order items).
- Powder-coated condenser and evaporator drain pan.
- Foam strip seal for supply air duct.
- Weather strip insulation.

Air systems

- Motors are thermally-protected PSC type.
- Air-stream surfaces are insulated with 1/4" fiber-glass or 1/8" (3.2 mm) Volara™.
- Indoor fan is forward-curved type, directly mounted to motor shaft.
- Unit mount controls include field selection switch to control indoor fan by either cycling with compressor operation or continuously with unit.

Condensate removal

- Outdoor fan incorporates condensate slinger ring. Condensate is thrown onto coil, where it evaporates, improving system performance.
- Thermostatic drain pan valve for condensate elimination when outdoor temperature drops below 60°F (15°C) (heat pump units only).

Controls

- Unit-mounted operating controls include thermostat, fan speed control, heat/cool switch, fan cycle switch, fresh air switch (if equipped)
- Ability to utilize 1-stage or 2-stage thermostat. 2 stage thermostat is capable of activating emergency heat if auxiliary heat source is available.
- Low ambient protection — see "Microprocessor control board" for details.
- Ability to control normally-open or normally-closed motor valve switch (on hydronic heat units only). Valve controls must be ordered for 24V or line voltage.
- All hydronic heat units include molex plugs for connection of hydronic valve motor.
- Remote mount controls include fan speed control and fresh air switch (if equipped)
- All units are equipped with manual reset high pressure switch which prevents abnormal high pressure operation, increasing compressor reliability.

GENERAL PRODUCT INFORMATION

Microprocessor Control Board

- Universal control board is used in straight cooling, electric resistance heat, hydronic heat, or cooling/heat pump applications.
- Random start timer prevents multiple units from simultaneous startups after power interruption or on initial power-up.
- Fan purge — fan remains on for 60 seconds after heat/cool is satisfied.
- Anti-short-cycle compressor protection prevents compressor from rapid cycling, increases compressor reliability.
- Freeze-protection prevents evaporator coil freeze up, improving compressor reliability.
- Low ambient lockout prevents compressor operation in outdoor temperatures less than 40°F (4.4°C). (On PTHP units supplied with unit-mounted control, control causes automatic changeover to auxiliary heat, if installed.)
- Test operation — all timers are temporarily suppressed to allow ease of testing or troubleshooting.
- Control board LED provides self-diagnostic troubleshooting codes, see "Sequence of operation."

Manufacturer Installed Options (Consult Manufacturer)

- 265/277V(12 and 15 only)
- 115V (09 &12 Models Only)
- Corrosion-resistant coil option — used for seacoast and harsh-environment usage; coated aluminum fin/copper tube condenser coil.
- Motorized fresh-air damper
- Supplemental electric heat — see heat options on "Model Coding" on page 6.
- Hydronic heat controls
- Front air intake

Field-Installed Accessories

- Hydronic heat — tcoil assembly shipped loose for field installation.
- Remote wall thermostat — digital 1-stage or 2-stage available.
- Wall sleeves, louvers, and cabinets
- Limit - delays fan start-up until coil reaches 100°F (38°C) to virtually eliminate "cold" blow condition.
- Hydronic control valve , Water 2 way & 3 way
- Hydronic control valve, Steam 2 way
- Hydronic Isolation valve, 1/2 in Sweat Connection.

GENERAL PRODUCT INFORMATION

Figure 1 R80C | R80H Chassis

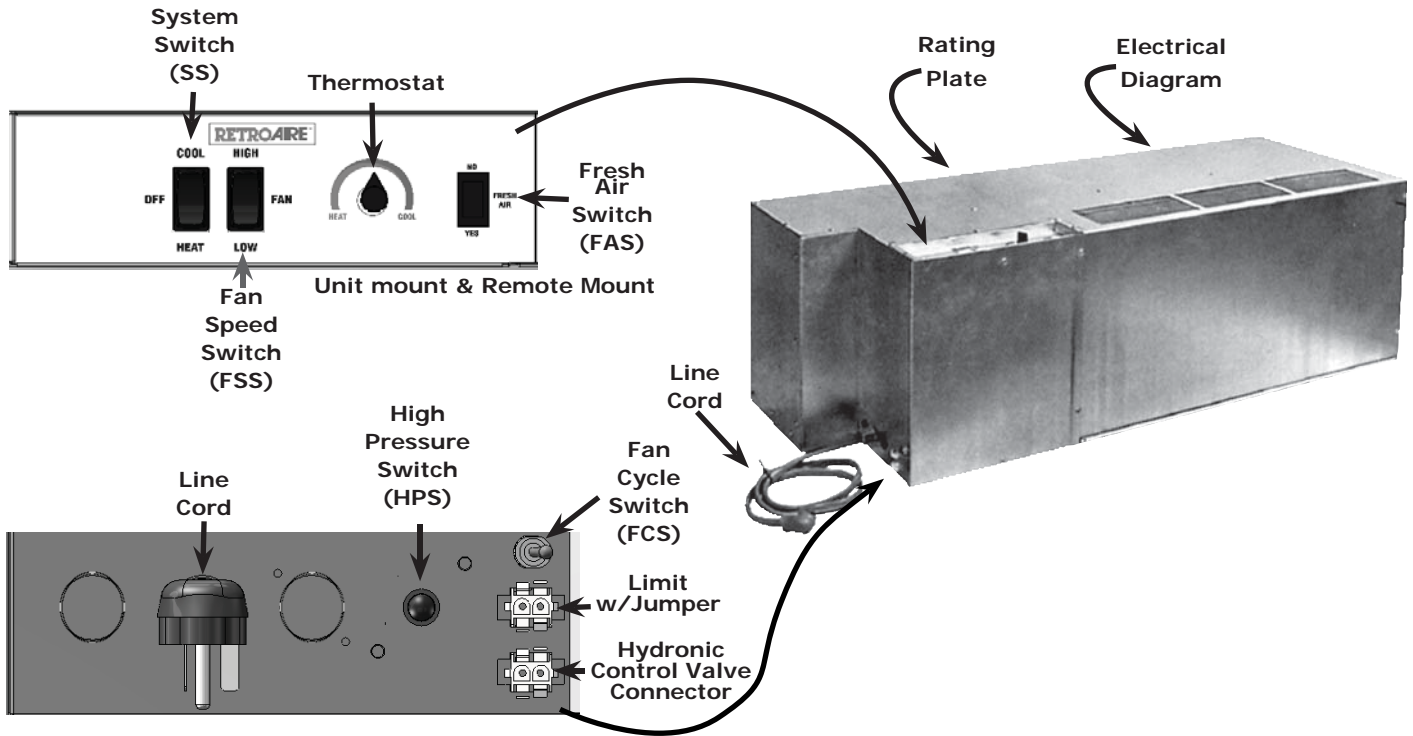
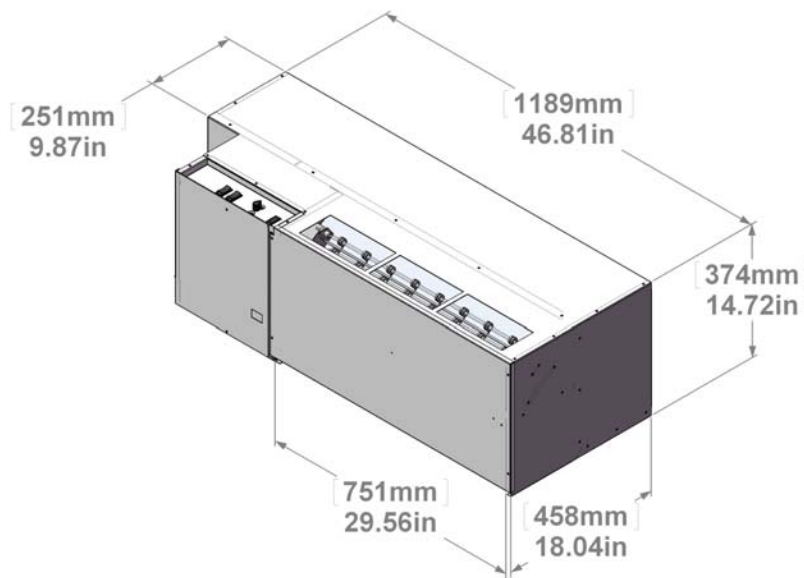

Figure 2 R80C | R80H Chassis

Note:

- Evaporator air intake bottom is standard
- Optional Kit for front air intake



Dimensions in [] are in mm

PTAC/PTHP MODEL CODING

Figure 3 Model Coding

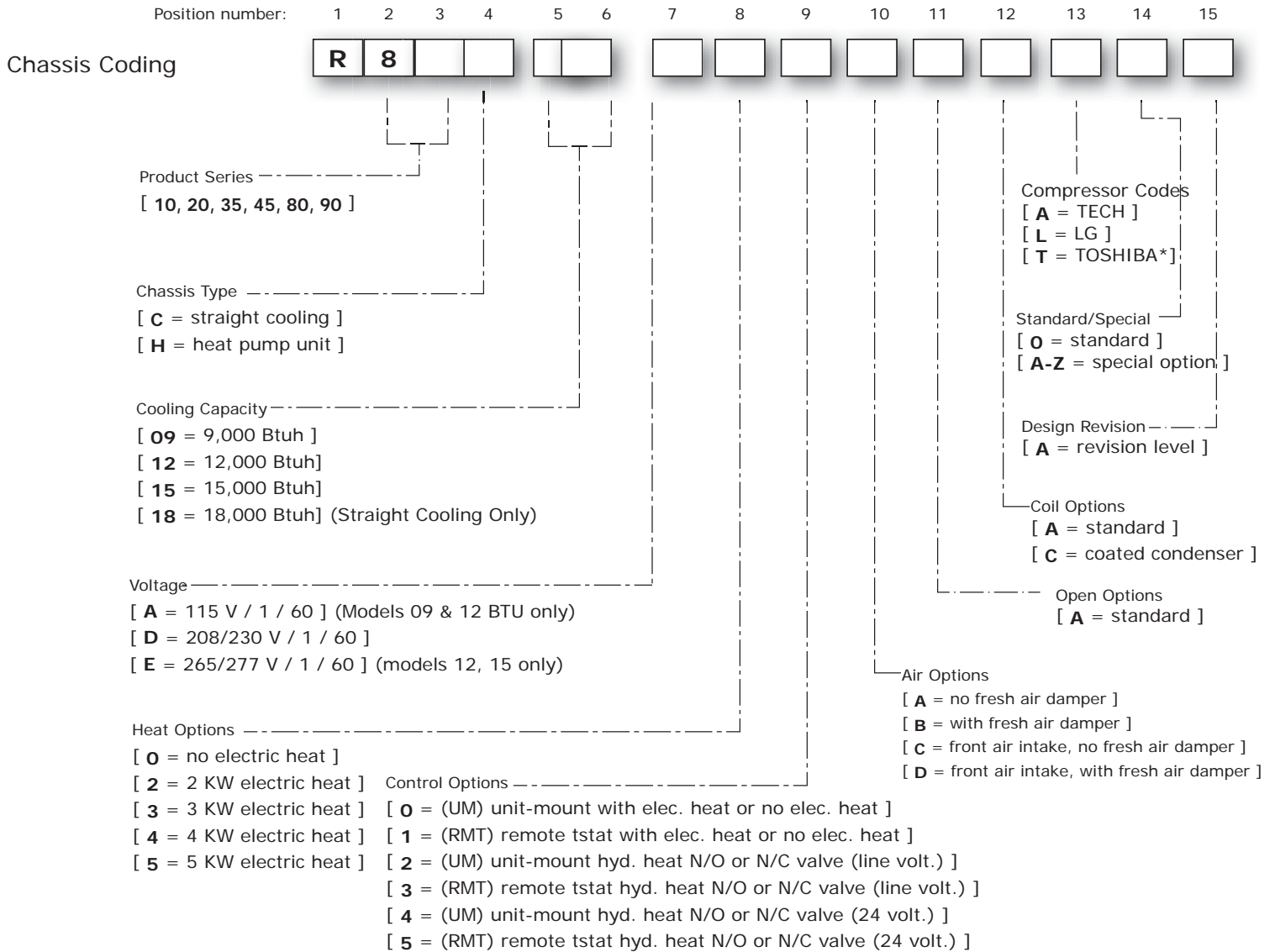

* Toshiba compressors subject to manufacturer availability.

Field Installed Accessories [items to be selected during the ordering process]

<input type="checkbox"/>	Remote thermostat	<input type="checkbox"/>	Aquastat
<input type="checkbox"/>	Hydronic Coil(contact factory)	<input type="checkbox"/>	Hydronic Control Valve
<input type="checkbox"/>	Single Piece cabinet / wall sleeve(contact factory)	<input type="checkbox"/>	Hydronic Isolate Valve

FEATURES

Indoor Coil Freeze Protection (Standard)

Feature prevents indoor coil from freeze up in cooling mode.

- Indoor coil freeze up can occur due to dirty air filter, restricted or poor air flow, low refrigerant charge or low room or outdoor temperatures.
- May cause compressor damage.
- Should freeze condition be detected, compressor and outdoor fan will be switched off for minimum of three minutes until freeze condition is satisfied.
- During this time indoor fan will continue to run to aid in defrost process.

Condensate Removal (Standard)

RetroAire replacement unit (cooling operation) is designed to eliminate condensate by slinging it onto outdoor coil.

- Condensate drains through bulkhead to area near outdoor fan.
- As part of its normal operation, unit will produce condensate and collect it in base pan of unit. It is picked up by outdoor fan slinger ring and deposited onto condenser coil. During cooling season, this improves unit's efficiency by maintaining reduced refrigeration system pressures.
- Base pan has overflow notches, if too much condensate is produced notches allow condensate to flow out of basepan and into wallsleeve out of building.

Thermostatic Drain Pan Valve (Standard On Heat Pump Units)

On heat pump models (PTHP), condensate can accumulate in outdoor drain pan during heat pump cycle.

- PTHP units include thermostatic drain valve that opens when outdoor temperatures fall below 60°F (15°C).
- When drain valve opens, condensate flows from drain pan onto bottom of wall sleeve, where it drains to outside.
- This keeps base pan free of condensate water, which could otherwise freeze during colder outdoor temperatures.

Random Start Feature (Standard)

Random start feature is initiated on initial power-up or after power interruption.

- Controller adds random time delay (from 5–120 seconds) on start-up, preventing compressor from starting.
- Staggering start of multiple units in single facility, preventing large surge that might occur if all units started at same time.

Anti-Short Cycle Timer (Standard)

Microprocessor control uses timer to prevent short-cycling of compressor.

- When compressor cycles off on heating or cooling call, controller starts 180-second timer.
- Compressor is not allowed to start until time has elapsed.
- On initial power-up or after power failure, this timing occurs after random start timing.

Power Cord With Integral Safety Protection (Standard)

All PTAC/PTHP units rated 250v or less are equipped with power cord with integral safety protection as standard.

- Providing personal shock protection as well as arcing and fire prevention. Designed to sense any damage in line cord and disconnect power before fire can occur.
- Tested in accordance with Underwriters Laboratories. Cord set offers unique "passive" operation, meaning unit does not require resetting if main power is interrupted.

Heat Pump

- Heat pump units are "Limited Range" and should be equipped with back-up electric resistance or hydronic heat.
- Limited Range heat pumps are designed to operate when outdoor temperatures are between 75°F(24°C) and 40°F(4.4°C) and with maximum indoor temperature of 80°F(26.6°C).
- Unit is equipped with reversing valve energized for cooling and de-energized in heating mode.
- Electric heating or hydronic heat will operate using onboard control logic below operating conditions of heat pump.

Hydronic Heating (Optional)

Optional hydronic heat package may be selected in lieu of electric heat. Heating operation is same as that of units with electric heat.

Limit Connection (optional)

Replacement PTAC/PTHP's with hydronic heat are supplied with standard line volt limit connection. Field installed limit delays fan operation until hydronic coil reaches temperature of 100°F (38°C).

FEATURES

Motorized Fresh Air Damper (Optional)

Motorized fresh air damper allows fresh air into space to be conditioned. When Fresh Air switch is in "YES" position damper door is open and allows fresh air into space. Feature is only available when indoor fan is on. When damper door switch is in "NO" position, damper door is closed and does not allow air in space.

Optional Wall-Mounted Thermostats

Thermostats Available From EMI

EMI offers thermostat that is compatible with your PTAC/PTHP unit.

- Select EMI part number 240008208 from latest RetroAire price list for this option. Single stage, cool/heat, thermostat that can be used in all RetroAire cooling, heating or heat pump applications.
- Thermostat has adjustable setpoint range of between 45°F(7°C) and 90°F(32°C).
- For heat pumps another option is EMI part number 240008209. This is 2 stage heat/cool thermostat which allows emergency heat.

Selecting A Thermostat

When selecting thermostat other than one offered by EMI, choose single stage heat/cool, 24v thermostat.

Straight cooling with electric heat or hydronic heat (R10C — PTAC's)

Select thermostat compatible with cooling/electric heat system.

Thermostat should have "R", "Y", "W", "C" and "G" terminals.

Heat Pump With Electric Heat (R__H - PTHPs)

Select thermostat that is compatible with cooling/single-stage heat/heat pump system.

Thermostat should have "R", "Y", "O" and "G" terminals. RetroAire units are single stage heating only.

Electric heat and heat pump will not operate simultaneously.

SEQUENCE OF OPERATION

Following Sequence of Operation applies to PTAC/PTHP units.

R_ _C units are straight cool, single stage air conditioners available with electric or hydronic heat.

R_ _H units are limited range, single stage heat pump. Mechanical compression heating (heat pump mode) is locked out at outdoor temperatures of approximately 35°F (1.7°C) and below. Below these ambient temperatures, auxiliary electric or hydronic heat will be used.

General

Unit is controlled by microprocessor. Thermostat and control connections are made to control board.

Figure 4 Control Board

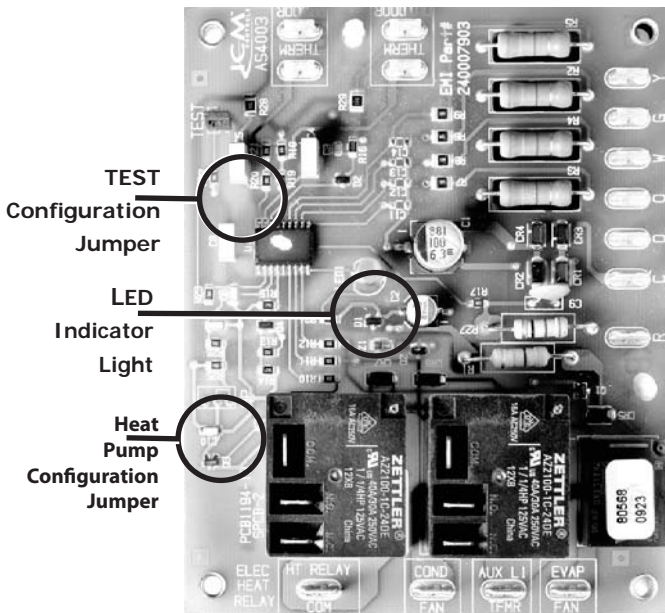

Two configuration jumpers are located on board, see Figure 8. Heat Pump Configuration Jumper is 3 pin jumper.

- Straight Cool units R_ _C, jumper locate on outside two pins.
- Heat Pump units R_ _H, the jumper locate on inside two pins.

Second configuration jumper "TEST" allows for control's internal timers by-passed for test purposes. Placing jumper on two pins enables test mode.

Status LED, LED1 is located on center of board. Series of blinks communicates status of board. Between blink sequence is separation of approximately 2 seconds.

Status Codes:

Trouble Code (Blinks)	Status
1	Normal Operation
2	Anti-Short Cycle Timer Active
3	Outdoor Coil Freeze Protection
4	Indoor Coil Freeze Protection
5	Simultaneous "Y" and "W" Call

Initial Power-Up or Power Restoration

- When power is applied for first time or after power failure, board will initialize. During initialization, LED1 is lit continuously for approximately 5 seconds.
- Following initialization, random start timer is initiated. Timer adds randomly selected 5-120 seconds to start-up sequence, reducing possibility of multiple units starting at same time.
- Once random start timer has expired, 180 second Anti-Short Cycle Timer is initiated and Processor Board Trouble Code LED is set to blink 2 flash code. Timer prevents compressor from rapid cycling.
- After Anti-Short Cycle Timer expires, Processor Board Trouble Code LED is set to blink 1 blink Trouble Code, indicating normal operation.

R_ _C / R_ _H; Cooling Operation

Unit Mount Controls

- System Switch [SS] set to "Cool", and Fan Cycle Switch [FCS] set to "On" (Continuous Fan Operation), indoor fan motor starts.
- Fan Cycle Switch [FCS] is set to "Off" (Cycling Fan Operation), indoor fan motor will start with call for cooling from internal thermostat [T'stat].
- Unit equipped with Motorized Fresh Air Damper, and is active with Fresh Air Switch [FAS], damper will open with call for indoor fan.
- Room temperature below thermostat setting fan operation will continue as noted above. If room temperature is above thermostat setting, reversing valve is energized, compressor and outdoor fan will start provided Anti-Short Cycle Timer has timed out from initial power-up, power restoration or previous compressor on cycle.
- Operation continues until room temperature satisfies thermostat. Once room temperature falls below set point by 3 °F (2 °C), compressor, outdoor fan motor and reversing valve will de-energize.

SEQUENCE OF OPERATION

- If FCS is set to "Off", indoor fan will continue to operate for 60 seconds after compressor stops.
- If FCS is set to "On", indoor fan will continue to operate. As soon as compressor is de-energized, Anti-Short Cycle Timer will initialize and will prevent compressor from starting again for another 180 seconds.
- While Anti-Short Cycle Timer is active, Processor Board Trouble Code LED is set to blink 2 flash code. After Anti-Short Cycle Timer expires, Processor Board Trouble Code LED is set to blink 1 blink Trouble Code, indicating normal operation.

NOTE:

- Remote-Mount Cooling Operation depends on features of wall-mounted thermostat. By default fan cycles with call for cooling. For thermostats with AUTO / ON fan switch, fan runs continuously if "ON" (Continuous Fan Operation). Fan cycles with call for cooling if set to "AUTO" (Cycling Fan Operation).
- Cooling units will not start if indoor air temperature is 60°F (15.5 °C) or below or if outdoor temperature is below 40°F (4.5°C).

R__C / R__H; Heating Operation

- System Switch [SS] set to "Heat", and Fan Cycle Switch [FCS] set to "On" (Continuous Fan Operation), indoor fan motor starts.
- Fan Cycle Switch [FCS] set to "Off" (Cycling Fan Operation), indoor fan motor starts with call for heating from internal thermostat [T'stat].
- Unit equipped with Motorized Fresh Air Damper, and active with Fresh Air Switch [FAS], damper opens with call for indoor fan.
- Room temperature above thermostat setting fan operation continues as noted above.
- Room temperature below thermostat setting, action of the unit depends on outdoor temperature and freeze sensor status.

NOTE: Remote-Mount Heating Operation depends on features of wall-mounted thermostat. By default fan cycles with call for Heating. For thermostats with AUTO / ON fan switch, fan runs continuously if "ON" (Continuous Fan Operation). Fan will cycle with call for heating if set to "AUTO" (Cycling Fan Operation).

- R__H; Mechanical Heating "Heat Pump"

If outdoor coil temperature remains above 25°F (-4 °C), compressor and outdoor fan start provided Anti-Short Cycle Timer has timed out from initial power-up, power restoration or previous compressor on cycle.

Operation continues until room temperature satisfies thermostat. Once room temperature rises above set point by 3°F (2°C), compressor and outdoor fan motor de-energize. If FCS is set to "Off", indoor fan continues to operate for 60 seconds after compressor stops. If FCS is set to "On", indoor fan continues to operate. As soon as compressor is de-energized, Anti-Short Cycle Timer is initialized and prevents compressor from starting again for another 180 seconds. While Anti-Short Cycle Timer is active, Processor Board Trouble Code LED is blinks 2 flash code. After Anti-Short Cycle Timer expires, Processor Board Trouble Code LED flashes 1 blink Trouble Code, indicating normal operation.

- R__H; Auxiliary Heating "Electric" or "Hydronic"

If outdoor coil temperature falls to 25°F (-4°C) or below for 180 seconds at anytime during heating call, compressor and outdoor fan motor de-energize and auxiliary heat energizes. Anti-Short Cycle Timer is initiated, prohibiting compressor operation for 180 seconds. Processor Board Trouble Code LED flashes 3 blink Trouble Code, indicating auxiliary heat operation. Heating operation with auxiliary heat continues until outdoor coil sensor reaches 50 °F (10 °C).

• "Electric Heat"

System Switch [SS] set to "Heat", and Fan Cycle Switch [FCS] set to "On" (Continuous Fan Operation), indoor fan motor starts. If Fan Cycle Switch [FCS] is set to "Off" (Cycling Fan Operation), indoor fan motor starts with call for heating from internal thermostat [T'stat]. Unit equipped with Motorized Fresh Air Damper, and is activated with Fresh Air Switch [FAS], damper opens with call for indoor fan. If room temperature is above thermostat setting fan operation continues as noted above. If room temperature is below thermostat setting, electric heater is energized until room temperature satisfies thermostat. Once room temperature increases above t set point by 3°F (2°C), electric heaters de-energize.

SEQUENCE OF OPERATION◦ **“Hydronic Heat”**

If FCS is set to “On” (Continuous Fan Operation) and unit has Limit, indoor fan and fresh air motorized damper operation are controlled by the Limit. If Limit senses temperature of $80 \pm 5^{\circ}\text{F}$ ($26 \pm 3^{\circ}\text{C}$) or below, indoor fan shuts down and motorized damper closes fresh air door. With call for heat, signal from processor board activates water or steam valve. Unit equipped with field installed Limit, indoor fan start is delayed until hydronic coil reaches $100 \pm 5^{\circ}\text{F}$ ($38 \pm 3^{\circ}\text{C}$). Signal to water or steam valve continues until room temperature rises above set point by 3°F (2°C). If FCS is set to “Off”, indoor fan continues to operate for 60 seconds or until hydronic coil temperature sensed by Limit reaches $80 \pm 5^{\circ}\text{F}$ ($26 \pm 3^{\circ}\text{C}$), whichever occurs first. If FCS is set to “On”, indoor fan de-energizes if Limit senses temperature of $80 \pm 5^{\circ}\text{F}$ ($26 \pm 3^{\circ}\text{C}$) or below.

◦ **“Remote Wall Thermostat Controls”**

Cooling and Heating operates identical to unit mount controls. See remote control manual for control details. Remote units do not use system switch, or FCS.

PERFORMANCE DATA

Table 1 R80 C/H Performance Data

Model R80	Cooling	Sensible Heat Ratio	EER	Heat Pump	COP	Indoor Air Flow	Fresh Air Inlet Flow	Outdoor Sound Level	Shipping Weight
	Btuh (kW)			Btuh (kW)		CFM (L/s)	CFM (L/s)	dBa	lbs (Kg)
R__C 09	9,200 (2.7)	0.79	9.5	N/A	N/A	400 (189)	35 (17)	75	140 (64)
R__H 09	9,200 (2.7)	0.79	9.5	8,500 (2.5)	2.90	400 (189)			
R__C 12	12,000 (3.5)	0.66	8.8	N/A	N/A	400 (189)	50 (24)	69	140 (64)
R__H 12	12,000 (3.5)	0.66	8.8	11,700 (3.4)	2.60	400 (189)			
R__C 15	14,700 (4.3)	0.69	8.3	N/A	N/A	425 (200)	60 (28)	70	140 (64)
R__H 15	14,700 (4.3)	0.69	8.3	14,000 (4.1)	2.52	425 (200)			
R__C 18	16,500 (4.8)	0.67	8.3	N/A	N/A	425 (200)	95 (45)	69	140 (64)

ELECTRICAL SPECIFICATIONS

Table 2 R80 - 9,000 Btu Electrical Specifications

Power Supply Volt — 1-60		Compressor		Indoor Fan Motor		Outdoor Fan Motor		Electric Heat				Unit Electrical Ratings				
Volt	Min	RLA	LRA	FLA	Hp	FLA	Hp	Htr #	Volt	W	HA	TCA	THA	MCA	MOCP	Plug
* 115V	104	7.5	47	1.4	0.09	1.4	0.125	N/A	N/A	N/A	N/A	10.5	N/A	12.4	15	5-15P
** 115V	104	8.0	45.6	1.4	0.09	1.6	0.125	N/A	N/A	N/A	N/A	11	N/A	13.0	20	5-15P
** 208/230V	197	4.0	22.2	0.6	0.08	0.71	0.09	0	N/A	N/A	N/A	5.3	N/A	6.3	15	6-15P
208/ 230V	197	3.9	20	0.6	0.08	0.71	0.09	0	N/A	N/A	N/A	5.2	N/A	6.2	15	6-15P
								2	208	1636	7.9		8.5	10.4	15	6-15P
									230	2000	8.7		9.3	11.5		
								3	208	2454	11.8		12.4	15.3	20	6-20P
									230	3000	13		13.6	16.9		
								4	208	3271	15.7		16.3	20.3	25	6-30P
									230	4000	17.4		18	22.3		
								5	208	4089	19.7		20.3	25.2	30	6-30P
									230	5000	21.7		22.3	27.8		
								265V	240	3.32	18.8		0.67	0.08	0.71	0.09
2	265	2655	10	10.7	13.2	15	7-20P									
3	265	3983	15	15.7	19.5	20										
4	265	5310	20	20.7	25.7	30	7-30P									
5	N/A	N/A	N/A	N/A	N/A	N/A	N/A									

Table 3 R80 - 12,000 Btu Electrical Specifications

Power Supply Volt — 1-60		Compressor		Indoor Fan Motor		Outdoor Fan Motor		Electric Heat				Unit Electrical Ratings				
Volt	Min	RLA	LRA	FLA	Hp	FLA	Hp	Htr #	Volt	W	HA	TCA	THA	MCA	MOCP	Plug
*115V	104	10.8	53	1.4	0.09	1.6	0.125	0	N/A	N/A	N/A	13.8	N/A	16.5	25	5-20P
**115V	104	12.7	63	1.4	0.09	1.6	0.125	0	N/A	N/A	N/A	15.7	N/A	18.9	30	5-20P
208/ 230V	197	5.6	29	0.6	0.08	0.71	0.09	0	N/A	N/A	N/A	6.9	N/A	8.3	15	6-15P
								2	208	1636	7.9		8.5	10.4	15	6-15P
									230	2000	8.7		9.3	11.5		
								3	208	2454	11.8		12.4	15.3	20	6-20P
									230	3000	13		13.6	16.9		
								4	208	3271	15.7		16.3	20.3	25	6-30P
									230	4000	17.4		18	22.3		
								5	208	4089	19.7		20.3	25.2	30	6-30P
									230	5000	21.7		22.3	27.8		
								265V	240	4.6	20		0.67	0.08	0.71	.09
2	265	2655	10	10.7	13.2											
3	265	3983	15	15.7	19.5	20										
4	265	5310	20	20.7	25.7	30	7-30P									
5	N/A	N/A	N/A	N/A	N/A	N/A	N/A									

* Toshiba Compressors

** Tecumseh Compressors

ELECTRICAL SPECIFICATIONS

Table 4 R80 - 15,000 Cooling Capacity Electrical Specifications

















Power Supply Volt — 1-60		Compressor		Indoor Fan Motor		Outdoor Fan Motor		Electric Heat				Unit Electrical Ratings				
Volt	Min	RLA	LRA	FLA	Hp	FLA	Hp	Htr #	Volt	W	HA	TCA	THA	MCA	MOCP	Plug
208/ 230V	197	7.4	33	0.6	0.08	0.71	0.09	0	N/A	N/A	N/A	8.7	N/A	10.6	15	6-15P
								2	208	1636	7.9		8.5	10.4	15	6-15P
									230	2000	8.7		9.3	11.5		
								3	208	2454	11.8		12.4	15.3	20	6-20P
									230	3000	13		13.6	16.9		
								4	208	3271	15.7		16.3	20.3	25	6-30P
									230	4000	17.4		18	22.3		
								5	208	4089	19.7		20.3	25.2	30	6-30P
									230	5000	21.7		22.3	27.8		
								265V	240	6	28		0.67	0.08	0.71	0.09
2	265	2655	10	10.7	13.2											
3	265	3983	15	15.7	19.5	20										
4	265	5310	20	20.7	25.7	30	7-30P									
5	N/A	N/A	N/A	N/A	N/A	N/A										

Table 5 R80 - 18,000 Cooling Capacity Electrical Specifications

Power Supply Volt — 1-60		Compressor		Indoor Fan Motor		Outdoor Fan Motor		Electric Heat				Unit Electrical Ratings				
Volt	Min	RLA	LRA	FLA	Hp	FLA	Hp	Htr #	Volt	W	HA	TCA	THA	MCA	MOCP	Plug
208/ 230V	197	8.3	44	0.6	0.08	0.71	0.09	0	N/A	N/A	N/A	9.6	N/A	11.7	15	6-15P
								2	208	1636	7.9		8.5	10.4	15	6-15P
									230	2000	8.7		9.3	11.5		
								3	208	2454	11.8		12.4	15.3	20	6-20P
									230	3000	13		13.6	16.9		
								4	208	3271	15.7		16.3	20.3	25	6-30P
									230	4000	17.4		18	22.3		
								5	208	4089	19.7		20.3	25.2	30	6-30P
									230	5000	21.7		22.3	27.8		

Note: Consult Manufacturer for 265V Option

ELECTRICAL SPECIFICATIONS

VOLTAGE	125V		250V			265V		
	15(A)	20(A)	15(A)	20(A)	30(A)	15(A)	20(A)	30(A)
PLUG	 5-15 P	 5-20 P	 6-15 P	 6-20 P	 6-30 P	 7-15 P	 7-20 P	 7-30 P
RECEPTACLE	 5-15 R	 5-20 R	 6-15 R	 6-20 R	 6-30 R	 7-15 R	 7-20 R	 7-30 R

ECR International Inc
2201 Dwyer Avenue
Utica, NY 13501
e-mail: info@RetroAire.com



An ISO 9001-2008 Certified Company