

RETROAIRE™

The Right Fit for Comfort

R40C / R41C

Packaged Terminal Air Conditioner (PTAC)

Installation, Operation & Maintenance Manual

Replacement for:
Fedders Model CMEA packaged Terminal Unit

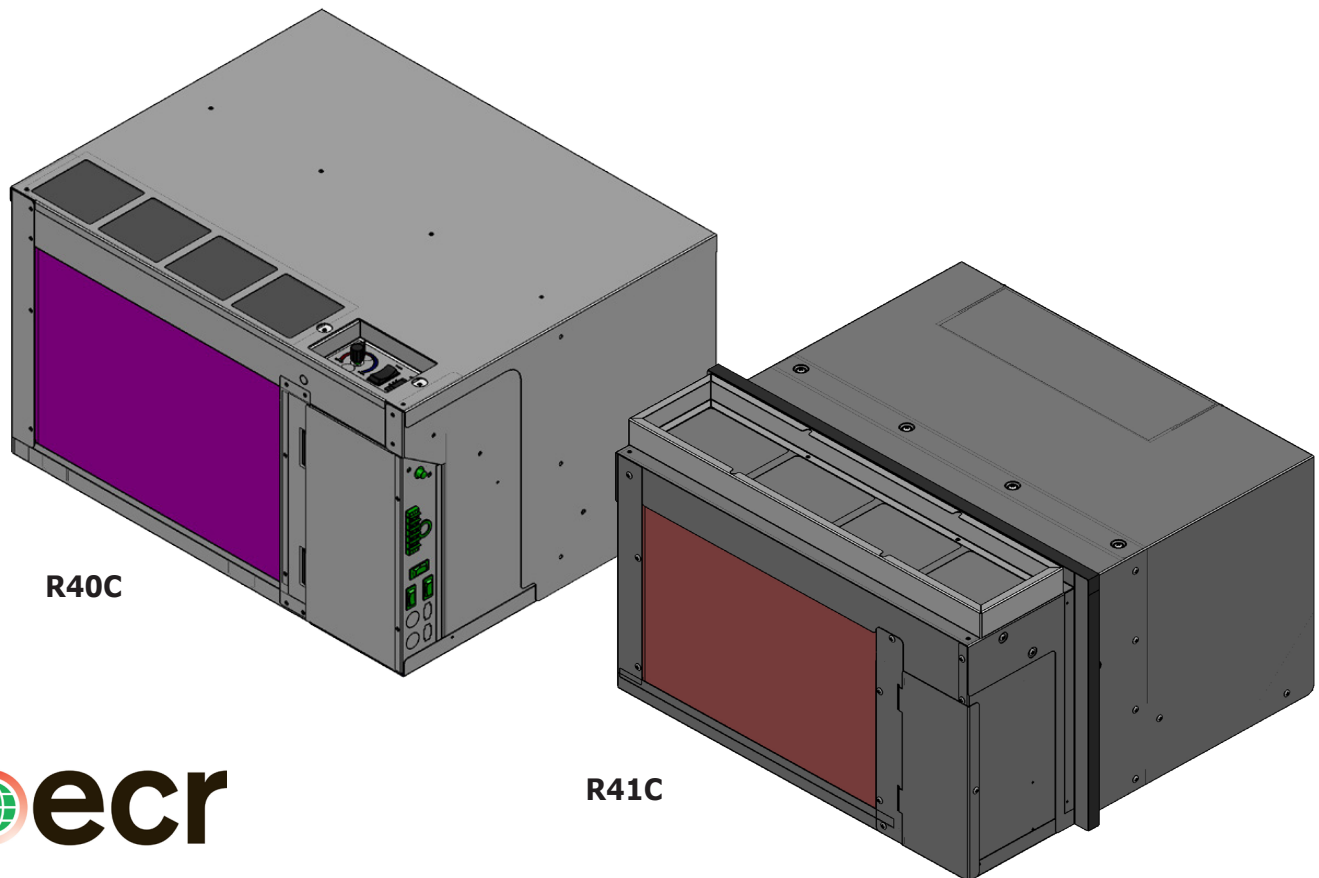

ECR International, Inc.

2201 Dwyer Avenue • Utica, New York 13501

Ph: 800.325.5279 • Web: retroaire.com

P/N 240010598 Rev. A [05/12/2014]

TABLE OF CONTENTS

Receiving Information	3
Important Safety Information	4
R40C - Dimensional/Physical Data	5
R41C - Dimensional/Physical Data	8
General Product Information	10
Features.....	11
Installation Preparation	12
Installation	13
R40C - Baffle Installation.....	14
R41C - Baffle Installation.....	15
Sequence of Operation	16
Final Inspection & Start-up	18
Maintenance	24
Troubleshooting	27
R40C - Performance Data	28
R41C - Performance Data	29
Warranty	31

AHRI Certified™ is a trademark of the Air-Conditioning, Heating and Refrigeration Institute. These units are tested and rated in accordance with: AHRI Standards 310/380 UL-484



Information and specifications outlined in this manual in effect at the time of printing of this manual. ECR International reserves the right to discontinue, change specifications or system design at any time without notice and without incurring any obligation, whatsoever.

RECEIVING INFORMATION

**Shipping damage MUST be reported to the carrier IMMEDIATELY.
Examine exterior.
Remove cover and examine compressor and piping for signs of damage.**

Inspection

Check shipment against bill of lading.

Verify equipment received as ordered.

Verify unit:

- Unit size and type correct per submittal sheet and job requirements?
- Louver color correct, if special color specified?
- Voltage correct?
- Electric heat correct capacity, if used?

Inspect each component for damage. Concealed damage **must** be reported to carrier within 15 days of receipt of shipment.

Carrier must make proper notation on delivery receipt of all damage identified and complete carrier inspection report.

Purchaser must notify Manufacturer's Service department of all damage and is responsible for filing any necessary claims with carrier.

General Information

Installation shall be completed by qualified agency. Retain this manual for future reference.

Installer, review this manual to verify unit has been installed correctly. Run unit for one complete cycle to verify proper function.

To obtain technical service or warranty assistance during or after installation, contact your local representative.

When calling for assistance, please have following information ready:

Model Number _____

Serial Number _____

Date of installation _____

Customer Service : (800) 228-9364

IMPORTANT SAFETY INFORMATION

All field wiring shall conform to requirements of authority having jurisdiction or in absence of such requirements:

- United States - National Electrical Code, ANSI/NFPA 70
- Canada - CSA C22.1 Canadian Electrical Code Part 1.

WARNING

Fire, and electrical shock hazard. Improper installation could result in death or serious injury. Read this manual and understand all requirements before beginning installation.



**Become Familiar With Symbols
Identifying Potential Hazards.**

DANGER

Indicates a hazardous situation which, if not avoided, WILL result in death or serious injury.

WARNING

Indicates a hazardous situation which, if not avoided, could result in death or serious injury.

CAUTION

Indicates a hazardous situation which, if not avoided, could result in minor or moderate injury.

NOTICE

Indicates information which should be followed to ensure proper installation and operation.

WARNING

Tampering with PTAC/PTHP is dangerous and could result in death or serious injury. Do not modify or change this unit.

Safety Information

- Installation by qualified personnel.
- Turn off electrical supply before servicing unit.
- Inspect all parts for damage prior to installation and start-up.
- Do not use unit if it has damaged wiring, is not working properly, or has been damaged or dropped.
- Connect to properly grounded electrical supply with proper voltage as stated on rating plate.
- Have proper over current protection (i.e. time delay fuse/HACR Breaker) as listed on Rating Plate.
- Connect unit to properly grounded electrical supply. Do not fail to properly ground this unit.

R40C - DIMENSIONAL/PHYSICAL DATA

Figure 1 R40C Dimensions - Inches (mm) Front View

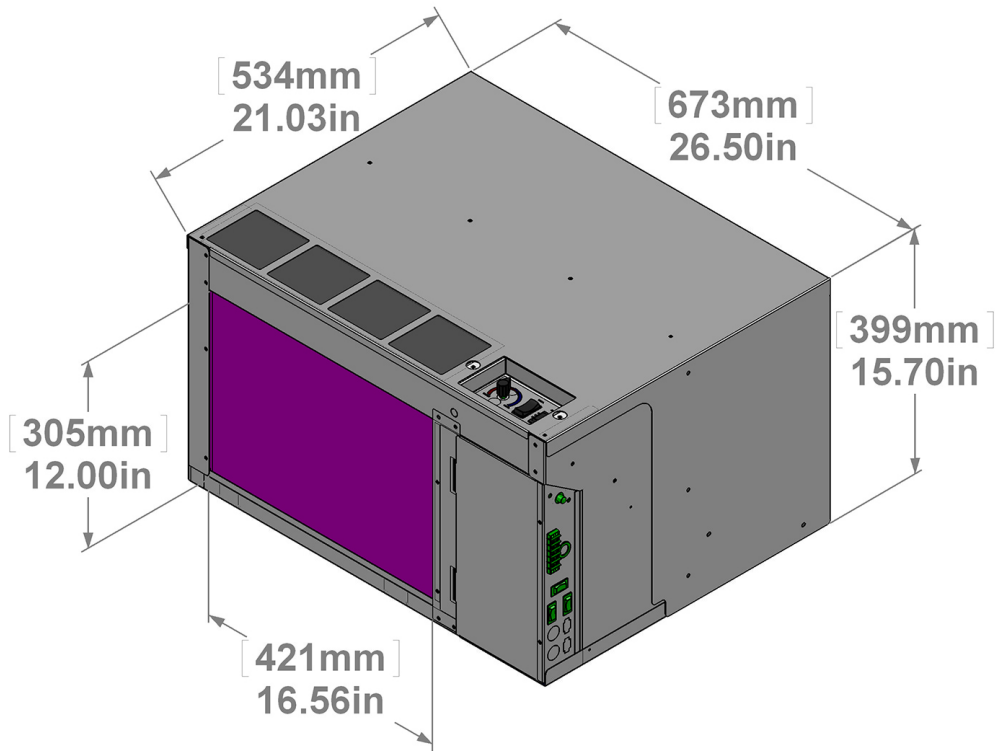

Figure 2 R40C Dimensions - Inches (mm) Rear View

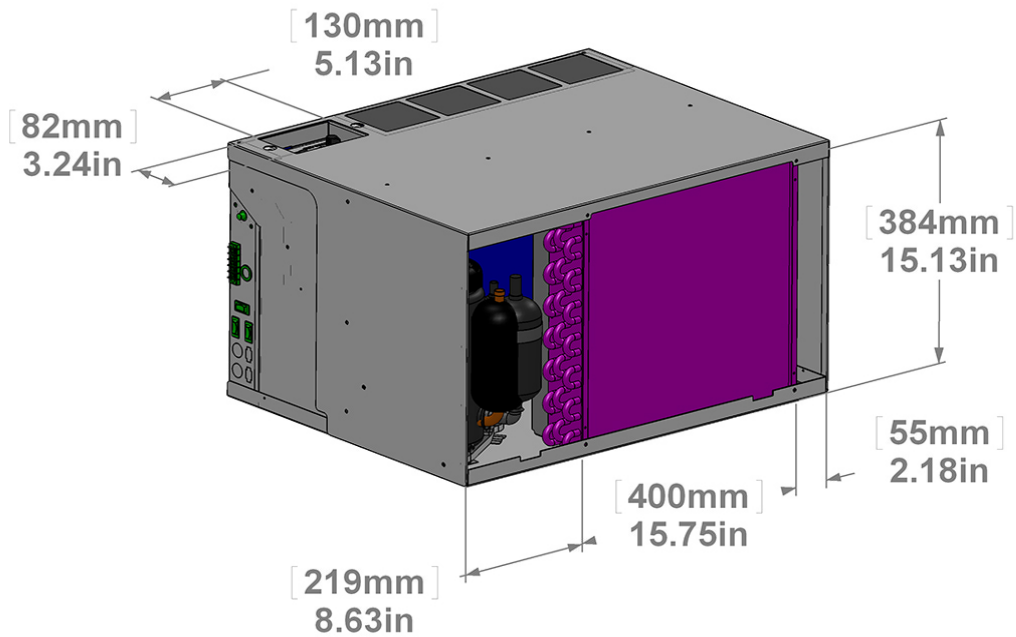

Figure 3 R40C Chassis

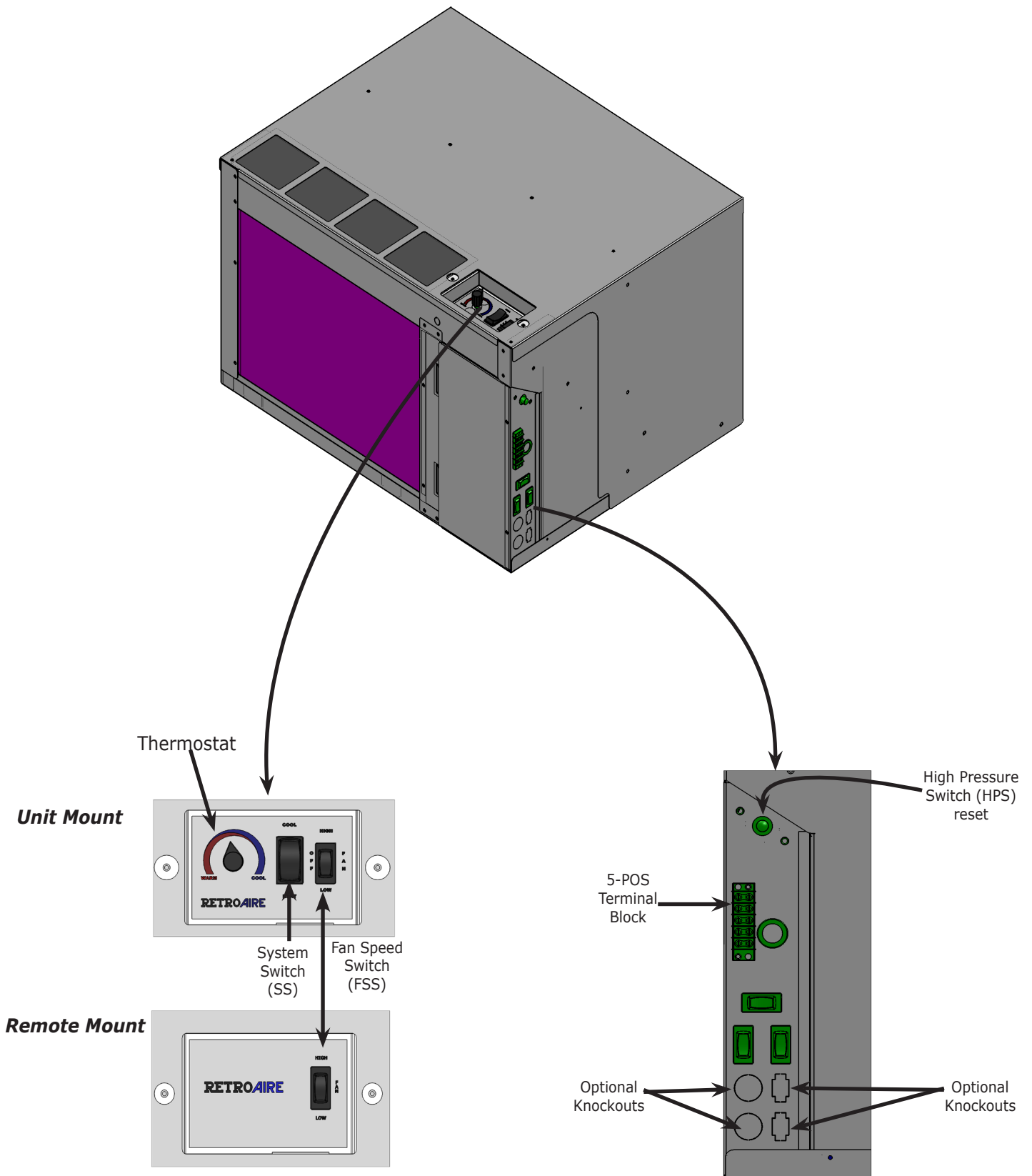
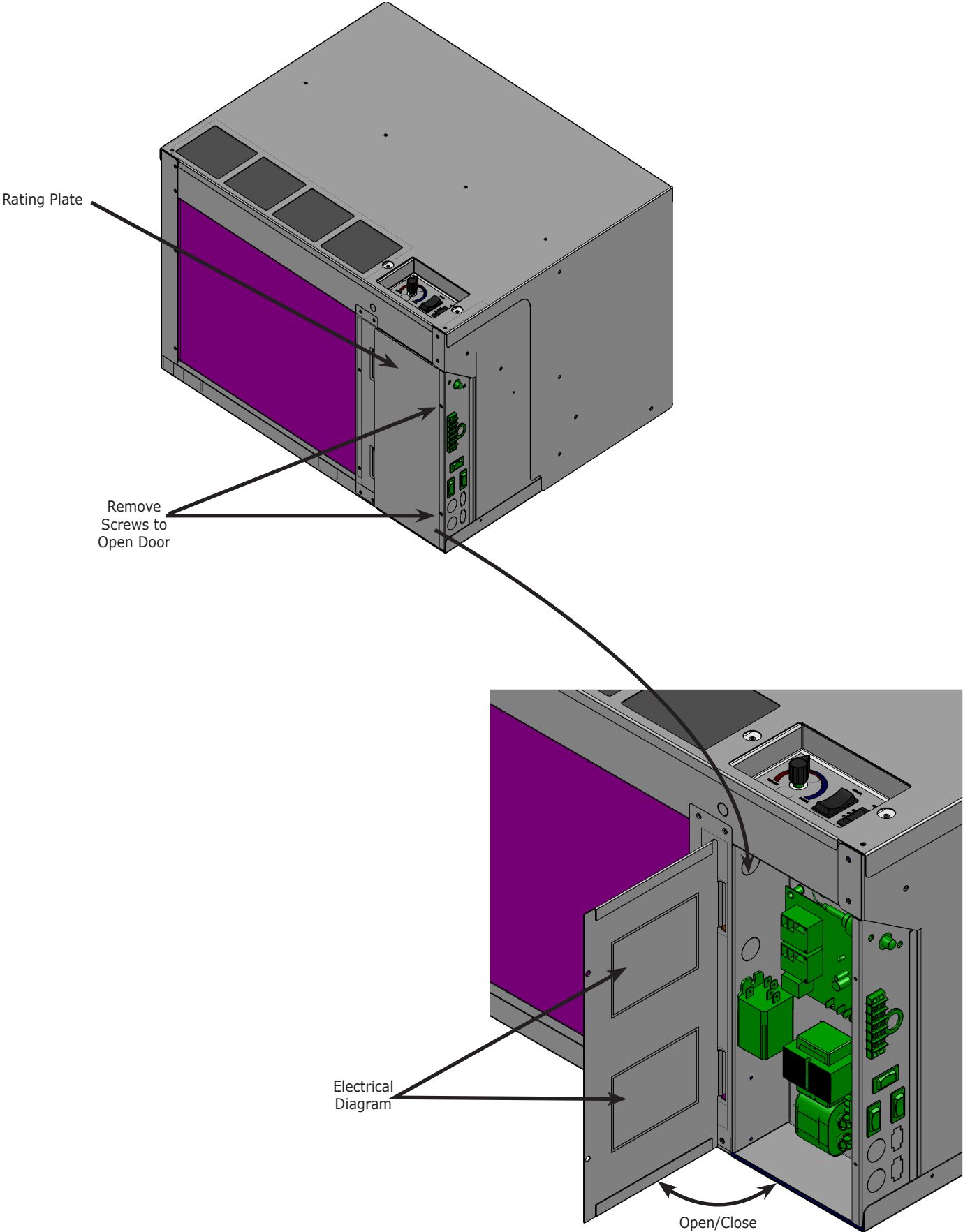

Figure 4 R40C Chassis Electrical Box



R41C - DIMENSIONAL/PHYSICAL DATA

Figure 5 R41C Dimensions - Inches (mm) Front View

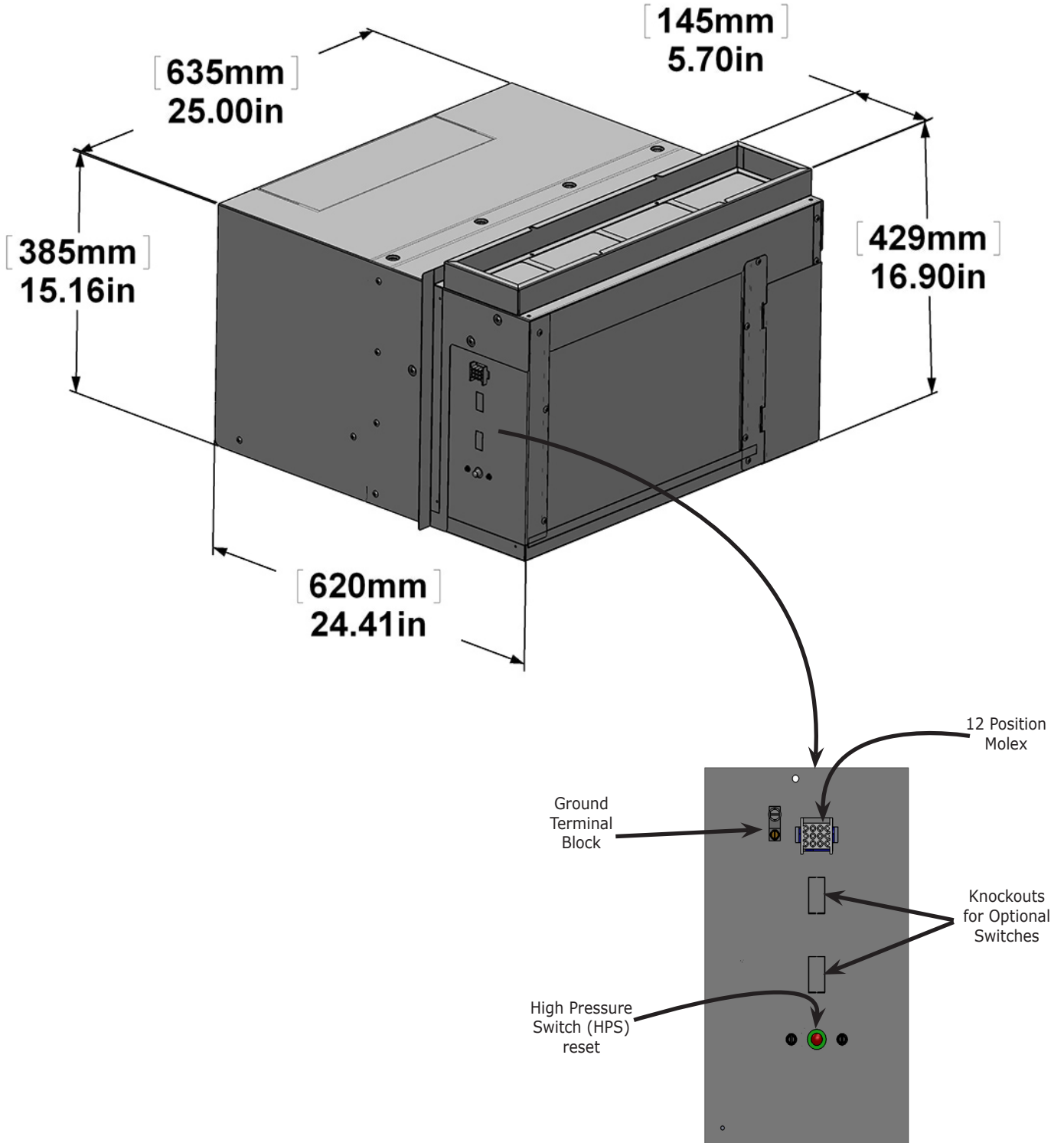
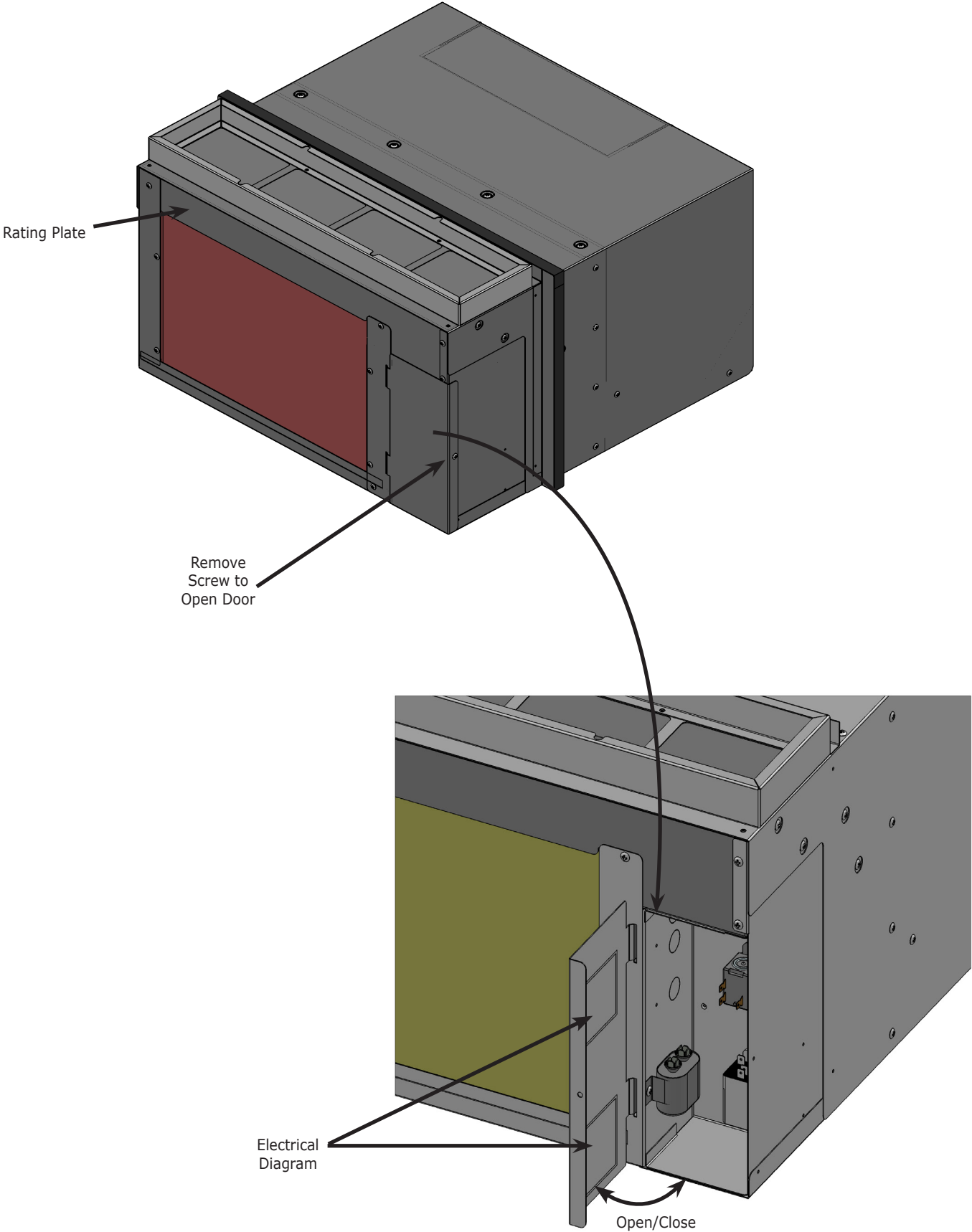

Figure 6 R41C Chassis Electrical Box



GENERAL PRODUCT INFORMATION

Product Description

- Available in straight cooling (PTAC).
- Use R-410A refrigerant.
- Include high-efficiency rotary compressors, protected by a 5-year warranty.
- Include enhanced high-efficiency heat exchangers.
- Offer two fan speeds.
- Incorporate positive condensate re-evaporation to improve efficiency.
- Have optional motorized fresh-air feature with positive pressure seal.
- PTAC units are available in nominal sizes of 9,000 Btuh, (2.6kW) 12,000 Btuh (3.5kW) or 15,000 Btuh (4.4kW) 18,000 Btuh (5.3kW).
- Energy Efficiency Rating (EER) as high as 9.

Standard Controls And Components

– Construction

- 20-gauge galvanized steel construction of chassis.
- Condenser baffle options to accommodate extended wall sleeve applications.
- Powder-coated condenser and evaporator drain pan.
- Foam strip seal for supply air duct.
- Weather strip insulation.

– Air Systems

- Thermally-protected PSC type motors.
- Air-stream surfaces insulated with 1/4" fiber-glass or 1/8" (3.2 mm) Volara™.
- Forward-curved type indoor fan, directly mounted to motor shaft.
- Unit mount controls include field selection switch to control indoor fan by cycling with compressor operation or continuously with the unit.

– Condensate Removal

- Outdoor fan incorporates condensate slinger ring. Condensate is thrown onto coil, where it evaporates, improving system performance.
- Thermostatic drain pan valve for condensate elimination when outdoor temperature drops below 60°F (15°C), heat pump units only.

– Controls

- Unit-mounted operating controls include thermostat, fan speed control, heat/cool switch, fan cycle switch, fresh air switch, if equipped.
- Ability to utilize 1-stage or 2-stage thermostat. 2 stage thermostat is capable of activating emergency heat if auxiliary heat source is available.
- Low ambient protection — see "Microprocessor control board" for details.
- Ability to control normally-open or normally-closed motor valve switch, available on hydronic heat units only. Order valve controls for 24V or line voltage.

- All hydronic heat units include molex plugs for connection of hydronic valve motor.
- Remote mount controls include fan speed control and fresh air switch, if equipped.
- All units are equipped with manual reset high pressure switch which prevents abnormal high pressure operation, increasing compressor reliability.

– Microprocessor Control Board

- Universal control board is used in straight cooling, electric resistance heat, hydronic heat, or cooling/heat pump applications.
- Random start timer prevents multiple units from simultaneous startups after power interruption or on initial power-up.
- Fan purge — fan remains on for 60 seconds after heat/cool is satisfied.
- Anti-short-cycle compressor protection prevents the compressor from rapid cycling, increases compressor reliability.
- Freeze-protection prevents evaporator coil freeze up, improving compressor reliability.
- Low ambient lockout prevents compressor operation in outdoor temperatures less than 40°F (4.4°C). PTHP units supplied with unit-mounted control, Control causes automatic changeover to auxiliary heat, if installed.
- Test operation — all timers are temporarily suppressed to allow ease of testing or troubleshooting.
- Control board LED provides self-diagnostic troubleshooting codes, see "Sequence of operation."

Field-Installed Accessories

- Hydronic heat — coil assembly is shipped loose for field installation.
- Remote wall thermostat — digital 1-stage or 2-stage available.
- Wall sleeves, louvers, and cabinets
- Aquastat - delays fan start-up until coil reaches 100°F (38°C) to eliminate "cold" blow condition.
- Hydronic control valve, Water 2 way & 3 way
- Hydronic control valve, Steam 2 way
- Hydronic Isolation valve, 1/2 in Sweat Connection.

Indoor Coil Freeze Protection (Standard)

Prevents indoor coil from freeze up in cooling mode.

- Indoor coil freeze up can occur due to a dirty air filter, restricted or poor air flow, low refrigerant charge or low room or outdoor temperatures.
- This can cause compressor damage.
- Should freeze condition be detected, compressor and outdoor fan switch off for minimum of three minutes until freeze condition is satisfied.
- During this time the indoor fan continues to run to aid in defrost process.

FEATURES

Condensate Removal (Standard)

RetroAire replacement unit, cooling operation, is designed to eliminate condensate by slinging it onto outdoor coil.

- Condensate drains through the bulkhead to the area near the outdoor fan.
- Unit as part of normal operation produces condensate and collects it in the unit's base pan. It is picked up there by the outdoor fan slinger ring and deposited onto the condenser coil. This improves the unit's efficiency by maintaining reduced refrigeration system pressures.
- Base pan has overflow notches. If too much condensate is produced notches allow condensate to flow out of the base pan and into the wall sleeve out of the building.

Random Start Feature (Standard)

Random start feature is initiated on initial power-up or after a power interruption.

- Controller adds a random time delay (from 5–120 seconds) on start-up, preventing compressor from starting.
- This staggers the start of multiple units in a single facility, preventing a large surge if all units started at the same time.

Anti-Short Cycle Timer (Standard)

Microprocessor control uses this timing to prevent compressor short-cycling.

- When the compressor cycles off on heating or cooling call, controller starts a 180-second timer.
- Compressor is not allowed to start until this time has elapsed.
- On initial power-up or after a power failure, this timing occurs after the random start timing.

Power Cord With Integral Safety Protection (Standard)

All PTAC/PTHP units rated 250V or less are equipped with power cord with integral safety protection as standard.

- Providing personal shock protection as well as arcing and fire prevention. Device is designed to sense any damage in line cord and disconnect power before a fire can occur.
- Tested in accordance with Underwriters Laboratories, cord set offers a unique "passive" operation, meaning unit does not require resetting if main power is interrupted.

Hydronic Heating (Optional)

Hydronic heat package may be selected in lieu of electric heat. Heating operation is same as that of units with electric heat.

Aquastat Connection (Optional)

All replacement PTAC/PTHP's with hydronic heat are supplied with standard line volt Aquastat connection. Field installed Aquastat delays fan operation until hydronic coil reaches temperature of 100°F (38°C).

Motorized Fresh Air Damper (Optional)

Motorized fresh air damper allows fresh air into the space to be conditioned. When the Fresh Air switch is in "YES" position, damper door is open and allows fresh air into the space. This is only available when the indoor fan is on. When damper door switch is in the "NO" position, the damper door is closed and does not allow air in the space.

Optional Wall-Mounted Thermostats

PTAC compatible thermostats.

- Manufacture offers single stage, cool/heat, thermostat that can be used in all RetroAire cooling, heating or heat pump applications.
- Thermostat has adjustable setpoint range of between 45°F (7°C) and 90°F (32°C).
- For heat pumps manufacture offers a 2 stage heat/cool thermostat which allows for emergency heat.

Selecting A Thermostat

When selecting a thermostat for the PTAC choose a single stage heat/cool, 24V thermostat.

Straight cooling with electric heat or hydronic heat (R10C – PTAC's) oling/electric heat system. Thermostat should have "R", "Y", "W", "C" and "G" terminals.

Heat Pump With Electric Heat (R__H - PTHPS)

Select a thermostat compatible with cooling/single-stage heat/heat pump system.

Thermostat should have "R", "Y", "O" and "G" terminals. RetroAire units are single stage heating only.

Electric heat and heat pump will not operate simultaneously.

INSTALLATION PREPARATION

DANGER

Electrical shock hazard — Verify power to existing unit is disconnected before removing. Failure to do so will result in death or serious injury.

CAUTION

Moving parts can cause personal injury. Avoid contact with moving parts when testing or servicing the unit. Failure to follow these instructions could result in minor or moderate injury.

Verify existing wall sleeve/enclosure:

1. RetroAire PTAC/PTHP's are to be used with metal wall sleeves.
2. Existing front panels must be secured by screws that prevent contact with all parts.
3. Minor dimensions of openings must not exceed ½ inch (12.5mm).
4. Indoor air discharge grill must have dimensions not less than 26" x 4". Grill must separate top surface of chassis from top surface of discharge grill by minimum of 1 in (25.4mm).
5. For all models, outdoor openings must prevent contact of all moving parts by means of louvers or grills, with minor dimension not exceeding 1 in (25.4mm).

Electrical Power Connection

All wiring shall conform to requirements of authority having jurisdiction or in absence of such requirements:

- United States
National Electrical Code, ANSI/NFPA 70
UL 1995 4th Addition.
- Canada
CSA C22.1 Canadian Electrical Code Part 1.

Installer is responsible for ensuring units are installed in accordance with all applicable national and local codes.

UNITS RATED 208/230V — RetroAire unit is wired for 230v primary voltage from manufacture.

Transformer must be rewired by installer if job site voltage is 208V. Change transformer tap from orange to red. See wiring diagram for details.

1. Verify RetroAire unit rating plate for circuit ampacity and required breaker or fuse size.
2. Verify existing breaker or fuse is correct size.
 - A. Replace breaker or fuse if incorrectly sized.
 - B. Breakers must be type HACR only.
3. Cord connected units — verify wall outlet is correct rating. Outlet's blade configuration must match that of cord supplied with RetroAire unit.
4. Hard-wired units — verify power wiring is correctly sized. Inspect existing wiring for deficiencies, such as cuts or frayed wires. Replace any deficient wiring if found.

5. Each unit must have separate branch circuit protected by fuse or breaker. Refer to unit rating plate for proper wire and breaker or fuse size. Use of extension cords is prohibited.
6. DO NOT connect RetroAire unit to circuit with incorrectly sized overcurrent protection device.
7. All cord-connected 265-volt units must be plugged into receptacles within unit subbase or chassis.
8. Open power supply disconnect switch. Secure in open position during installation. Attach sign stating, "DO NOT TURN ON."
9. On a plug and receptacle connection, unplug existing unit at the wall outlet. DO NOT plug in the new unit until installation is complete and start-up checklist has been completed.

Remove Old Chassis

1. Disconnect power or unplug cord before proceeding.
2. Remove front of the existing room enclosure to expose old chassis.
3. Loosen any tie-down bolts or screws. Remove old chassis.

NOTICE

Dispose of old chassis following existing state and federal regulations.

4. Inspect wall sleeve/cabinet for any rust, holes, or damage.
 - A. Clean wall sleeve of any dirt.
 - B. Repair any damage.
 - C. Ensure proper drainage of condensate or rainwater to exterior of building.
5. Remove or repair old weather seals. Note location for installation of any new seals.
6. Check wall sleeve/cabinet to ensure all drain holes are open and:
 - A. Wall sleeve/enclosure is level left to right
 - B. Back is pitched to outside by ½ in (12.5mm) maximum.
7. Before installing new chassis, inspect outdoor louver for minimum free area of 70% and remove any obstructions. Obstructions restrict air flow over condenser coil and may cause damage to the chassis.
8. Follow the installation instructions on the following pages.
9. DO NOT connect power to the unit or plug in the cord until instructions in this manual have been completed.

Installation

1. **Verify existing wall thickness.** Distance from condenser coil to outdoor louver varies with wall sleeve depth. Units shipped with factory installed baffles.
 Manufacturer offers alternate air baffle kits for unique applications. Wall sleeve depth is required when ordering to ensure proper baffle size.
2. **Connecting optional hydronic coil controls.** If hydronic heat option has been ordered, field install the hydronic coil on the new unit. Coil with old unit can be located in subbase, under chassis in a special attachment, or above chassis in a special attachment. It is necessary to know where the coil is to be located and physical size of the coil so the new coil can be verified if ordered for replacement. The new coil should be installed in the same manner as the coil it is replacing. Hydronic coils are not factory installed and need to be ordered.
 - Remove 2-position connector assembly from kit bag supplied with unit. This will have 2 yellow wires attached.
 - Splice 2 yellow wires to valve motor using 2 - crimp popcorn.
 - Connect this 2-position connector to 2-position connection located on bottom of control box panel.
3. **Connecting accessory field installed Aquastat.**
 - A. Remove black jumper wire located on bottom panel of control box. This is terminated with 2-position connector.
 - B. Cut jumper wire in the middle and splice the Aquastat to jumper using 2 - crimp popcorns.
 - C. Place connector back into original location. Refer to wiring diagram on unit for details.
4. **Install Baffles - Install correct condenser baffles for proper performance of unit. See Figures 7 and 8**
 - A. Slide unit back out of wall sleeve.
 - B. Remove both sets of provided baffles from accessory bag. Install only one set of left and right side baffles on the condenser coil.
 - C. Choose the proper fitting baffles for your application by verifying selected baffles come in contact with outdoor louver.
 - D. Verify baffles are directed inward toward center of coil.
 - E. Secure baffles tightly into existing holes of condenser coil using provided screws.
5. **Secure chassis** — Verifying all seals are correct size, located properly, and correct baffles are attached to condenser coil in proper orientation. Slide unit into final position and tighten tie down bolts or screws.
6. **Hard-wired units** — Hard wired units follow instructions on page 10 to verify existing wiring and over current protection.
 - A. Remove line cord wires from PTAC/PTHP power entrance terminals.
 - B. Route power supply wiring through strain-relief bushing and connect leads to power entrance terminals. Secure the strain-relief clamp.
 - C. If wiring is through conduit insert conduit through control box knockout and secure in place. **DO NOT** turn on power until completing instructions in "Final Inspection and Startup" page 22.
7. **DO NOT PLUG IN the line cord**, if used. Follow instructions in "Final Inspection and Startup" page 22.

R40C - BAFFLE INSTALLATION

Figure 7 R40C Baffle Options

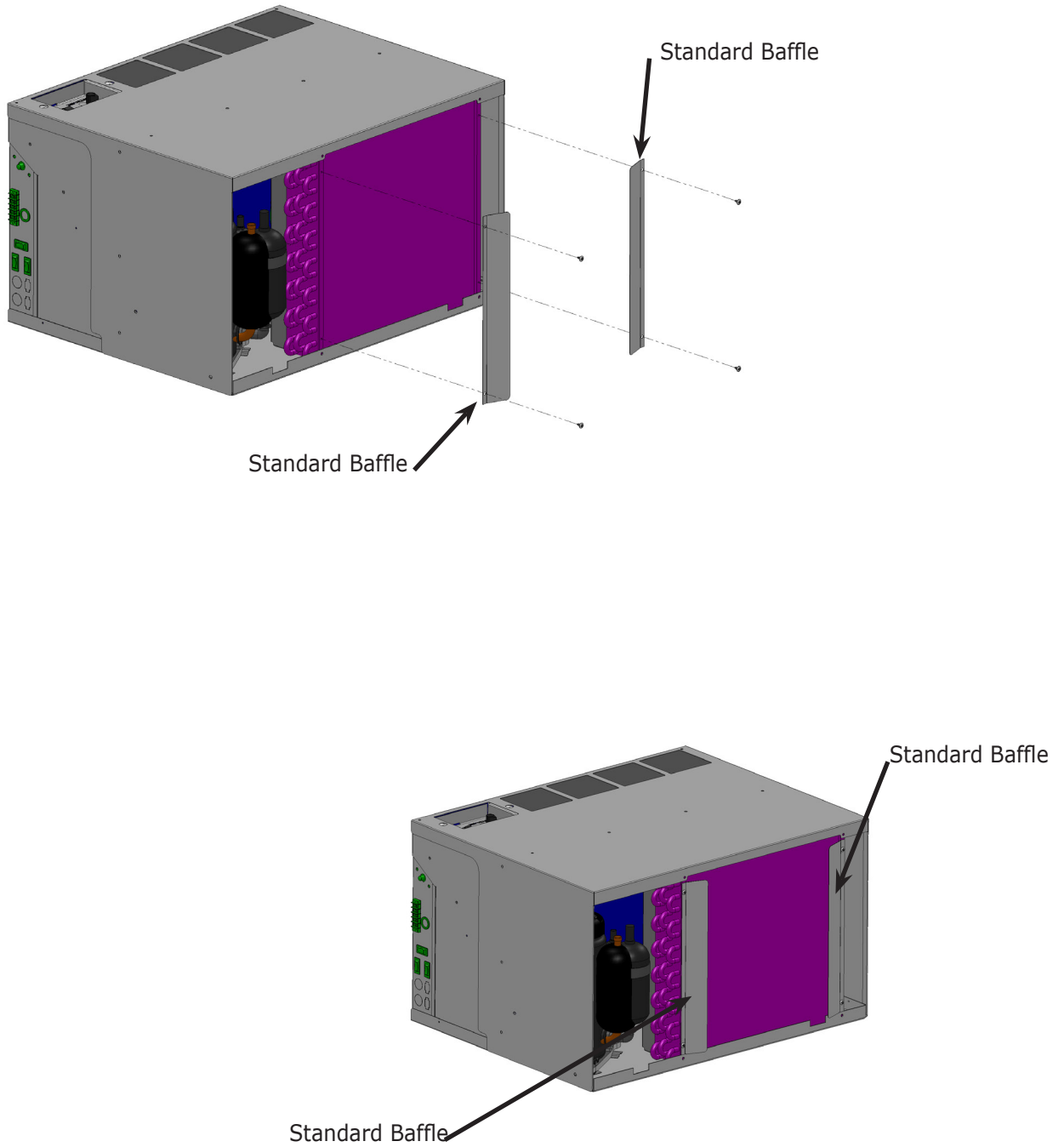

R41C - BAFFLE INSTALLATION

Figure 8 R41C Baffle Options and Field Ground Connection

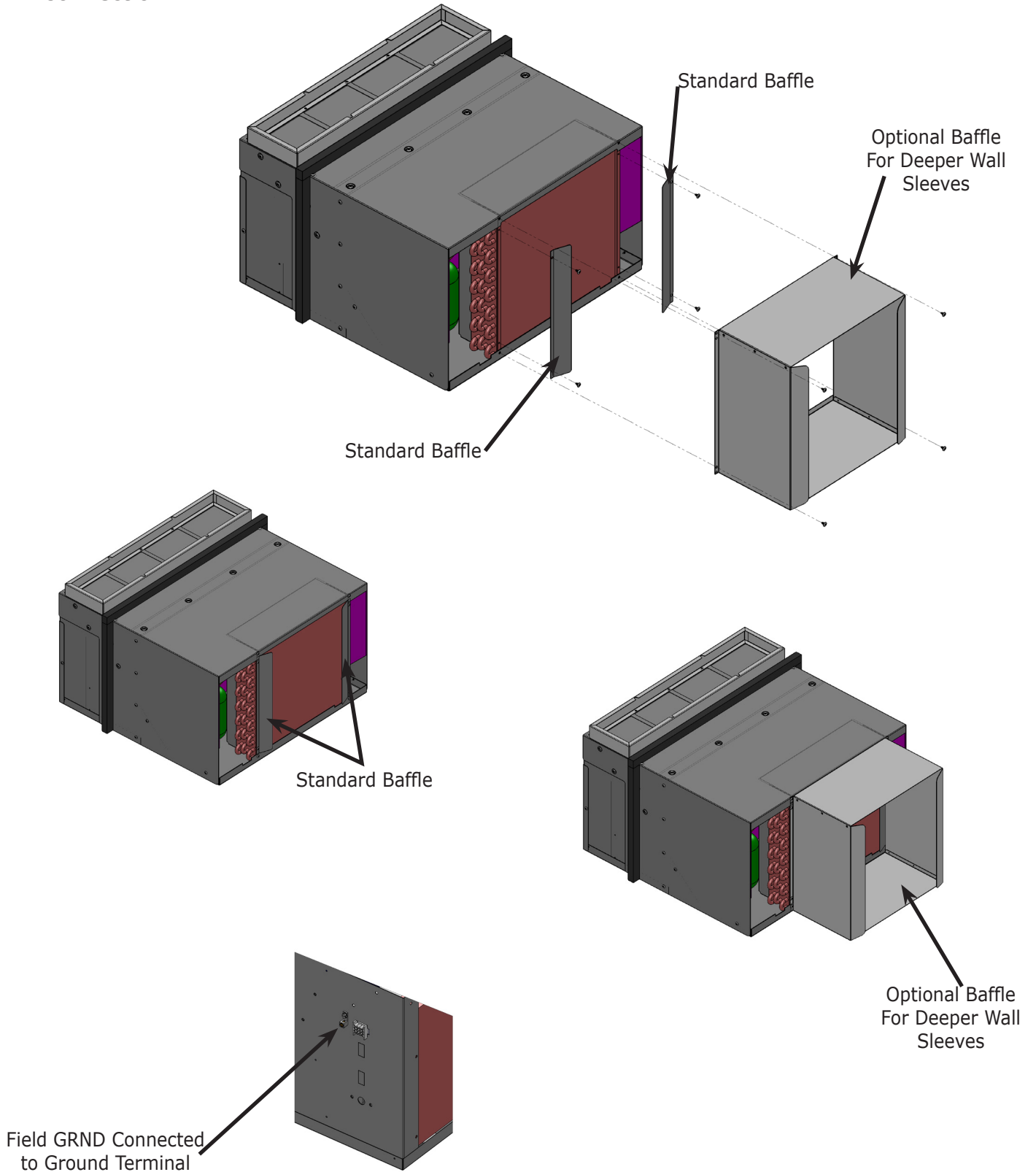

Sequence of Operation

- **R__C** units are straight cool, single stage air conditioners available with electric or hydronic heat.

General

Microprocessor controlled unit. Thermostat and control connections are made to the control board. Two configuration jumpers are located on the board. See Figure 9.

- Straight **Cool** units R__C, locate jumper on outside two pins.

Second configuration jumper "TEST" allows for control's internal timers to be by-passed for test purposes. Placing jumper on two pins enables test mode.

Status LED (Light Emitting Diode), LED1 is located on center of board. Series of blinks communicates board status. Between blink sequence is separation of approximately 2 seconds. See Table 1.

Initial Power-Up or Power Restoration

- When power is applied to the unit, either for the first time or after a power failure, board initializes itself.
- During initialization, LED1 is lit for approximately 5 seconds.
- Following initialization, a random start timer is initiated. Timer adds randomly selected 5-120 seconds to start-up sequence, reducing possibility of multiple units starting at same time.
- Once random start timer has expired, 180 second Anti-Short Cycle Timer is initiated and Processor Board Trouble Code LED is set to blink a 2 flash code. Timer prevents compressor from rapid cycling.
- After Anti-Short Cycle Timer expires, Processor Board Trouble Code LED is set to blink 1 blink Trouble Code, indicating normal operation.

R__C ; Cooling Operation

Unit Mount Controls

- With System Switch [SS] set to "Cool", and Fan Cycle Switch [FCS] set to "On" (Continuous Fan Operation), indoor fan motor starts.
- If Fan Cycle Switch [FCS] is set to "Off" (Cycling Fan Operation), indoor fan motor starts with call for cooling from internal thermostat [T'stat].
- If equipped with Motorized Fresh Air Damper, and is active with Fresh Air Switch [FAS], damper will open with call for the indoor fan.
- If room temperature is **below** thermostat setting fan operation continues as noted.
- If room temperature is **above** thermostat setting, reversing valve is energized. Compressor and outdoor fan start provided Anti-Short Cycle Timer has timed out from initial power-up, power restoration or previous compressor on cycle. Operation will continue until room temperature satisfies the thermostat.

Figure 9 - Control Board

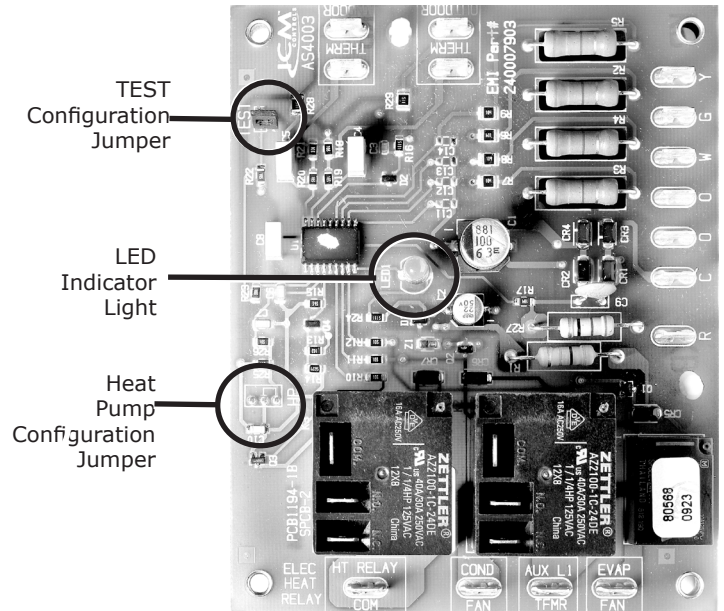

Table 1 - Status Codes

Trouble Code (Blinks)	Status
1	Normal Operation
2	Anti-Short Cycle Timer Active
3	Outdoor Coil Freeze Protection
4	Indoor Coil Freeze Protection
5	Simultaneous "Y" and "W" Call

SEQUENCE OF OPERATION

- Once room temperature falls below set point by 3° F (2° C) compressor, outdoor fan motor and reversing valve will de-energize.
- If FCS is set to "Off", indoor fan continues to operate for 60 seconds after compressor stops.
- If FCS is set to "On", indoor fan continues to operate.
- As soon as the compressor is de-energized, Anti-Short Cycle Timer is initialized and prevents compressor from starting again for another 180 seconds.
- While Anti-Short Cycle Timer is active, Processor Board Trouble Code LED is set to blink a 2 flash code.
- After Anti-Short Cycle Timer expires, Processor Board Trouble Code LED is set to blink 1 blink Trouble Code, indicating normal operation.

NOTE: Remote-Mount Cooling Operation depends on features of wall-mounted thermostat. By default fan will cycle with call for cooling.

For thermostats with **AUTO / ON** fan switch, fan will run continuously if this is "ON" (Continuous Fan Operation).

Fan cycles with call for cooling if this is set to "AUTO" (Cycling Fan Operation).

In cooling, units will not start if indoor air temperature is 60° F (15.5° C) or below or outdoor temperature is below 40° F (4.5° C).

R__C Heating Operation

- With System Switch [SS] set to "Heat", and Fan Cycle Switch [FCS] set to "On" (Continuous Fan Operation), indoor fan motor will start.
- If Fan Cycle Switch [FCS] is set to "Off" (Cycling Fan Operation), indoor fan motor will start with call for heating from the internal thermostat [T'stat].
- If equipped with Motorized Fresh Air Damper, and is active with Fresh Air Switch [FAS], damper opens with call for indoor fan.
- If room temperature is **above** thermostat setting fan operation continues as noted above.
- If room temperature is **below** thermostat setting, action of the unit will depend on outdoor temperature and freeze sensor status.

NOTE: Remote-Mount Heating Operation depends on features of wall-mounted thermostat. By default fan will cycle with call for Heating.

For thermostats with AUTO / ON fan switch, fan runs continuously if this is "ON" (Continuous Fan Operation).

Fan cycles with call for heating if this is set to "AUTO" (Cycling Fan Operation).

A. R__H; Auxiliary Heating "Electric" or "Hydronic"

- If outdoor coil temperature falls to 25° F (-4° C) or below for 180 seconds at anytime during heating call, compressor and outdoor fan motor are de-energized and auxiliary heat is energized.

- Anti-Short Cycle Timer is initiated, prohibiting compressor operation for 180 seconds. Processor Board Trouble Code LED flashes 3 blink Trouble Code, indicating auxiliary heat operation.
- Heating operation with auxiliary heat continues until outdoor coil sensor reaches 50° F (10° C).

A.1 "Electric Heat"

- A. System Switch [SS] set to "Heat", and Fan Cycle Switch [FCS] set to "On" (Continuous Fan Operation), indoor fan motor starts.
- B. If Fan Cycle Switch [FCS] is set to "Off" (Cycling Fan Operation), indoor fan motor starts with call for heating from internal thermostat [T'stat].
- C. If unit is equipped with Motorized Fresh Air Damper, and is activated with Fresh Air Switch [FAS], damper opens with call for indoor fan.
- D. If room temperature is **above** thermostat setting fan operation continues as noted above.
- E. If room temperature is **below** thermostat setting, electric heater is energized until room temperature satisfies thermostat.
- F. Once room temperature increases above set point by 3° F (2° C), electric heaters are de-energize.

A.2 "Hydronic Heat"

- A. If FCS is set to "On" (Continuous Fan Operation) and unit has Aquastat, the indoor fan and fresh air motorized damper operation are controlled by the Aquastat.
- B. If the Aquastat senses temperature of 80 ± 5° F (26 ± 3° C) or below, the indoor fan shuts down and the motorized damper closes fresh air door.
- C. With call for heat, signal from processor board activates water or steam valve.
- D. If unit is equipped with a field installed Aquastat [AS], the indoor fan start will be delayed until the hydronic coil reaches 100 ± 5 °F (38 ± 3 °C). The signal to the water or steam valve will continue until the room temperature rises above the set point by 3 °F (2 °C). If the FCS is set to "Off", the indoor fan will continue to operate for 60 seconds or until the hydronic coil temperature as sensed by the Aquastat reaches 80 ± 5 °F (26 ± 3 °C), whichever occurs first. If the FCS is set to "On", the indoor fan will de-energize if the Aquastat senses a temperature of 80 ± 5 °F (26 ± 3 °C) or below.

A.3 "Remote Wall Thermostat Controls"

Cooling and Heating operates identical to unit mount controls.

See remote controls manual for control details.

Remote units do not use a system switch, or FCS.

Before Operating The Unit

1. Install unit per the instructions outlined in this manual and all applicable local and national codes.
2. Verify electrical supply matches electrical requirements of the unit, and unit is properly grounded.
3. Examine control box. Verify all wire connections are secure, and control board jumpers are in proper positions.
4. Verify chassis is properly fitted to wall sleeve and securely mounted to surrounding framing.
5. Verify chassis is level: Pour water into drain pan. Verify it flows through the drain hoses to condenser side of unit.
6. Verify indoor blower wheels and outdoor fan blades are secured to their motor shafts, and rotate freely.
7. Verify all sheet metal panels are in place and secure.
8. Attach front panel to the existing cabinet enclosure.
9. Verify nothing interferes with room discharge air or return air of units.

Examples:

Check for curtains or drapes that obstruct air flow. See Figure 10 and Figure 11.

Check for plush carpeting that can obstruct return air.

These types of obstructions can cause serious damage to the chassis.

Any obstruction of supply air, including use of deflector baffles, may cause condensate to form on louver or cabinet. See Figure 11.

For optimum performance of your PTAC/PTHP, avoid restricting the air flow. Position of curtains or drapes over supply air grille may cause air to recirculate without cooling the room. Unit will short cycle and may cause premature compressor failure. See Figure 11.

Figure 10 - Proper Air Flow Diagram



Figure 11 - Restricted Air Flow Diagram



Electrical Connections

Installation and wiring shall be in accordance with requirements of authority having jurisdiction. In absence of such requirements refer to:

- USA- National Electrical Code, ANSI/NFPA 70.
- Canada - Canadian Electrical Code, Part I, CSA C22.1: Safety Standard for Electrical Installations.

Units Rated 208/230V:

- RetroAire unit is wired for 230V primary voltage from manufacturer.
- Transformer must be rewired by installer if job site voltage is 208V.
- Change transformer tap from orange to red. See wiring diagram for details. See Figure 4 page 6 and Figure 6 page 9 for location of wiring diagram.

Setting Control Board Jumpers

Control board has two sets of factory installed jumper pins: **HP** jumper and **TEST** jumper.

HP Jumper — selects heat pump or straight cooling.

Pins determine whether unit operates as straight cooling or as heat pump. See Figures 12 and 13.

- Jumper right pin to center pin for heat pump operation.
- Jumper left pin to center pin for straight cooling operation.

TEST Jumper — selects normal or test mode

NOTICE

Do not leave unit operating with TEST jumper in TEST position.

- Jumper is for testing only. See Figure 13 and 14.
- When jumper pins are jumped together, all timers are eliminated (*example — anti-short cycle, purge, etc.*).
- May be used for field testing. Units are factory set with jumper on only one pin (*normal operation position*).

Figure 12 - HP Jumper (selects heat pump or straight cooling)

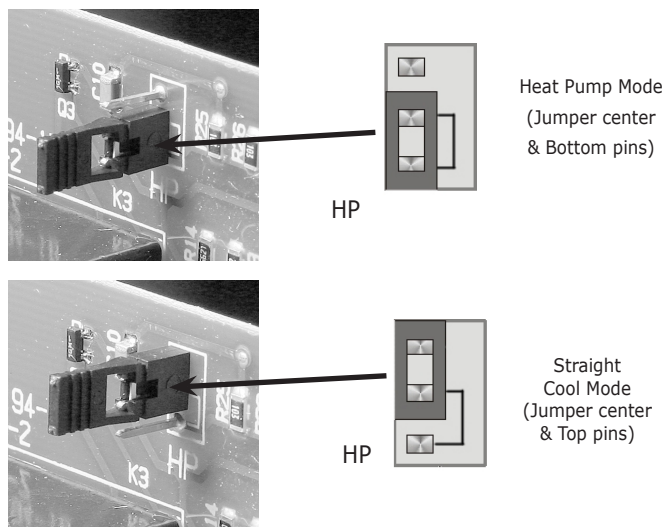

Figure 13 - TEST jumper (selects normal or test mode)

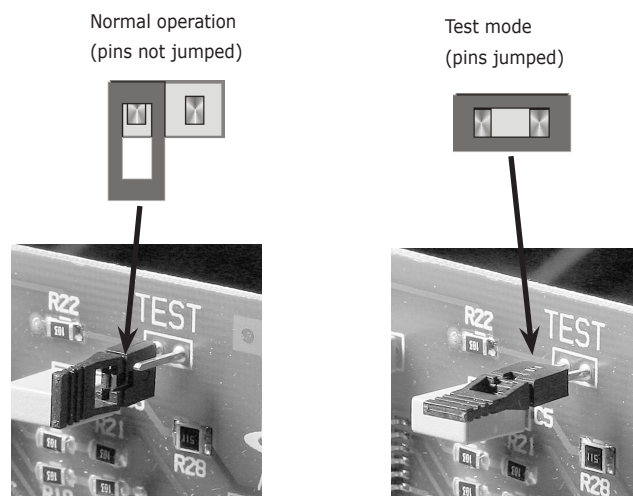
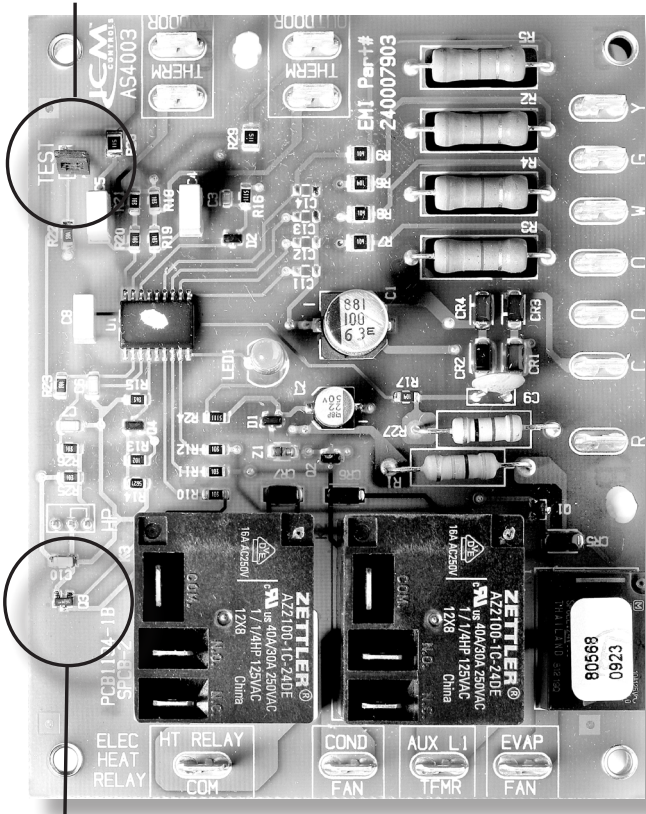

Figure 14 TEST jumper (selects normal or test mode)

TEST JUMPER



HEAT PUMP
JUMPER

Start Up

1. Verify unit is secure and level.
2. Heat pump units only — Verify thermostatic drain pan valve is operating correctly. Valve should be closed if temperature is above 60° F and open if below 60°F.
3. Test fresh air damper, if equipped, by setting damper door switch to "YES". Verify damper opens and allows fresh air to be moved into the space. Set damper door switch to "NO". Verify flow of air into the space has stopped. Fresh air is only available when indoor fan is operating.
4. Verify HP jumper is set correctly for unit type, cooling only or heat pump. See Figure 12, page 19.
5. Set TEST jumper to test mode, this disables time delays, including anti-short-cycle and purge times. See Figure 13, page 19.
6. Verify unit is wired correctly, including requirements on page 16.
7. Connect Electric power to unit.
8. Turn unit on. Verify proper operation.
9. Verify condensate removal:
 - A. Pour water into base pan.
 - B. Place unit in cooling mode, with condenser fan operating, verify water is picked up by slinger ring and thrown onto outdoor coil.

Compressor will not start until anti-short time period has elapsed.

On power-up, there are delays for control board initialization and random start timing. See Sequence of Operation Section, page 16.

Unit Mounted Thermostat

1. Use system switch to place PTAC/PTHP in COOL, HEAT, or OFF position. Test operation in all positions. See Figure 15.
2. Use fan speed switch to place fan in LOW or HIGH speed. Test operation in both positions for heating and cooling. See Figure 15.
3. Test operation of Fan Cycle switch, toggle switch on side of control box. Set switch to ON, continuous fan operation, or AUTO, cycling with thermostat, for both heating and cooling. Set switch in desired position.
4. Rotate thermostat knob left to increase setpoint temperature, or right to decrease.
 - Turning unit-mounted thermostat knob to far left produces the warmest room temperature.
 - Turning thermostat knob all the way to the right produce coolest room temperature.
 - Setting can be adjusted for personal comfort. See Figure 15.

Figure 15 Typical Representation - Unit Mount Control

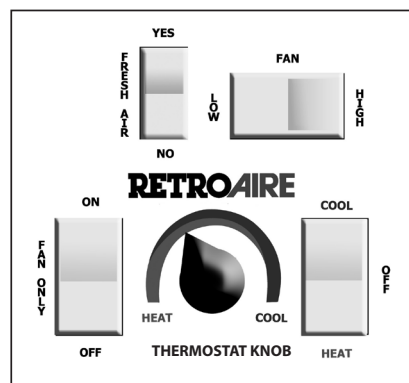

Do not rotate thermostat knob back and forth from heating to cooling.

This causes compressor to cycle on and off rapidly and will cause damage to the compressor.

Allow compressor to remain off for at least three minutes prior to restarting the unit.

Remote Mounted Thermostat

1. Use thermostat to place PTAC/PTHP in COOL, HEAT, or OFF position. Test operation in all positions.
2. If thermostat is fitted with fan switch, set as desired places the fan in either ON, OFF, or AUTO. Test operation in all positions.
3. Check thermostat calibration for both heating and cooling operation.

Straight Cooling PTAC's

Important Information

- Room temperature must be above 65°F (18°C) for compressor to operate in cooling mode on PTAC's with unit-mounted controllers.
- Room temperature must be below 85°F (29.4°C) to energize the heater on PTAC's with unit-mounted controllers.
- Room temperature must be below 85°F (29°C) for hydronic heater to operate on PTAC's with unit-mounted controllers.
Hydronic valve is 24 Vac normally open valve. Should power be interrupted, valve will default to open position.
- When unit is first powered up, high humidity conditions may cause condensation to form on discharge grill. Keep doors and windows closed to reduce humidity allowing condensation to evaporate.

Cooling Cycle

1. Place thermostat or system switch in **COOL** position.
2. Adjust thermostat to cooler temperature until indoor fan starts running. Compressor and outdoor fan will turn on and cold air will begin to flow from unit. Allow unit to continue operating to cool the room and remove humidity.
3. After unit starts and space gets cooler, adjust thermostat to warmer temperature until compressor cycles off.
4. If a colder room temperature is desired, adjust thermostat to cooler temperature setting, turn compressor and both fans back on.
5. If a warmer room temperature is desired, adjust thermostat to warmer temperature setting. Compressor and outdoor fan stop, indoor fan switches off after sixty-second purge time has elapsed.
6. Place thermostat or system switch in **OFF** position. All operation will stop.

Heating Cycle – Electric Option

1. Outdoor fan does not run during heating cycle.
2. Place thermostat or system switch in **HEAT** position.
3. Adjust thermostat for warmer temperature until indoor fan starts running and electric heater coil starts emitting heat.
4. After unit starts running and space gets warmer, adjust thermostat to cooler temperature until electric heater turns off.
5. If warmer room temperature is desired, adjust thermostat to warmer temperature setting, which will turn electric heater on.
6. If cooler room temperature is desired, adjust thermostat to cooler temperature setting until electric heater turns off. Indoor fan will switch off after sixty-second purge time has elapsed.
7. Place thermostat or system switch in **OFF** position. All operation will stop.

Heating Cycle – Hydronic Option

Before Starting The unit:

- Verify motor valve is rated for correct voltage.
- Most RetroAire units with unit mount controls will power a hydronic valve that is the same voltage as the unit (ex: a unit rated 208/230v will power a 208/230v).
- Switch is provided on control box to change from NO to NC.
- Verify wiring using wiring diagram, located on the unit, and voltage application for the specific unit.
- Other valve configurations and voltage options are available. Consult Technical Service if unit voltage does not match your valve application.

Starting the unit:

1. Place thermostat or system switch in **HEAT** position.
2. Adjust thermostat to warmer temperature.
3. A signal from processor board will activate the water or steam valve.
4. The motorized valve will open and allow hot water or steam to run through the coil.
5. Indoor fans run, blowing air through the hydronic coil
6. If the unit is equipped with an Aquastat, the indoor fan and motorized damper operation are delayed until the hydronic coil reaches 100 ± 5°F (38 ± 3°C).
7. The signal to water or steam valve continues until room temperature rises above setpoint by 3°F (2°C).
8. Once the area gets warmer, adjust thermostat to a cooler temperature. The hydronic valve closes and indoor fan switches off after sixty-second purge time has elapsed.
9. If warmer room temperature is desired, adjust thermostat to warmer temperature setting, which opens the hydronic valve and turns on the indoor fan.
10. If cooler room temperature is desired, adjust thermostat to cooler temperature setting. Hydronic valve closes and indoor fan switches off after sixty-second purge time has elapsed.
11. Place thermostat or system switch in **OFF** position. All operation stops.

Testing Completion For Cooling-Only PTAC's

Operation testing is now complete.

If TEST jumper was set to test mode verify it is set back to normal operation. See Figure 10, page 16.

NOTICE

Do not leave unit operating with TEST jumper in TEST position.

Auxiliary Heating Operation — Electric Option

Room temperature must be below 85°F(29°C) to energize heater on PTHP's with unit-mounted controllers.

1. Place thermostat or system switch in **HEAT** position.
2. Adjust thermostat to warmer temperature until indoor fans start running and electric coil starts emitting heat.
3. After space gets warmer, adjust thermostat to cooler temperature until electric heater turns off.
4. If warmer room temperature is desired, adjust thermostat to warmer temperature setting, which will turn electric heater back on.
5. If cooler room temperature is desired, adjust thermostat to cooler temperature setting until electric heater turns off. Indoor fan will switch off after sixty-second purge time has elapsed.
6. Place thermostat or system switch in **OFF** position.
All operation stops.

Electric Heat Models

Manually reset limit switch if the limit switch opens and de-energizes the electric heat.

To reset switch:

- Turn power off
- Remove control box cover.
- Locate limit switch.
- Push reset button in, located on the face of the switch

⚠ **WARNING**

Electrical shock hazard. Disconnect power to unit before servicing or accessing control compartment. Failure to do follow these instructions could result in death or serious injury.

NOTICE

Perform regular service and maintenance by qualified service agency at least once every 12 months to assure safe, trouble free operation and maximum efficiency.

NOTICE

Verify proper operation after servicing.

Maintenance Schedule

Manufacturer recommends performing following inspections and maintenance on monthly basis. Units installed in harsh or dirty environments will require more frequent inspections and maintenance.

Disconnect power to unit and remove necessary access panels:

- ❑ Clean or replace indoor air filter.
- ❑ Inspect chassis interior for rodent or insect infestation. Clean if necessary.
- ❑ Clean & flush condensate drain pan and chassis base pan.
- ❑ If applicable, verify condensate drain is functioning properly.
- ❑ Inspect refrigeration tubing, especially braze joints, for signs of refrigerant leaks (oil residue). Repair if necessary.
- ❑ Inspect indoor and outdoor coils. Verify dirt or debris have not collected on fins. Clean if necessary. Take care not to damage coil fins when cleaning. Use fin comb to straighten any bent fins.
- ❑ Examine control box. Verify all wire connections are secure.
- ❑ Verify indoor blower wheels and outdoor fan blades are secured to their motor shafts.
- ❑ Verify dirt or debris have not collected on indoor blower wheels and outdoor fan blades. Use vacuum and soft brush to clean if necessary.
- ❑ Verify any ductwork connected to unit is secure and free of air leaks.
- ❑ **ELECTRIC HEAT MODELS** — in event the limit switch opens and de-energizes the electric heat, limit switch will need to be manually reset. See Figures 16, 18 and 19. To reset switch:
 - Remove the control box cover.
 - Locate the limit switch.
 - Push in the reset button on the face of the switch.

Figure 16 - Manual Reset Limit Switch

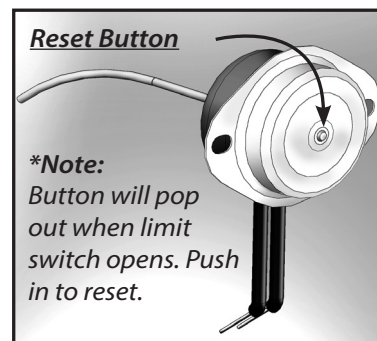

Seasonal Start-Up And Maintenance

Beginning of cooling and heating seasons, complete mechanical check should be performed and maintenance/inspections performed as described below.

Disconnect power to unit and remove necessary access panels:

1. Remove access panel. Visually inspect equipment. Look for obvious changes in unit such as damaged coils or evidence of extended wear on any moving parts.
2. Check for unusual odors or leaks (examples: burnt motor windings, water, or refrigerant). Verify base pan is clean.
3. Clean or replace return air filter as needed. Check filter at least once month. Some environments may require more frequent replacement, depending on particulate in air stream.
4. Inspect all electrical connections for frayed wires and poor connections.
5. Check fan motors and blower assemblies. Verify screws and motor mounting hardware are tight.
6. Centrifugal fan blades and blower cage brush and/or vacuum as necessary.
7. Inspect both indoor and outdoor coils. Use fin comb to straighten out any damaged fins.

NOTICE

Do not use solvent based cleaner to clean coils, some solvents will produce noxious odor when unit is in operation or may deteriorate components.

8. Look for oil leaks or stains on or around all braze joints and refrigerant lines. Presence of oil here indicates potentially serious problem, such as refrigerant leak.
9. Inspect and clean drain pan and drain line(s). Use of anti-fungicide tablet to keep condensate system free from bacterial contaminants is recommended.
10. Verify unit is level for proper operation. Building and equipment may settle, causing shift in direction of condensate flow. Verify weep holes along rear flange of base pan are free of debris.

11. Air leaks may make the conditioned area uncomfortably drafty or produce noises. Visually inspect foam gasket between wall and unit, taking note of separation between air inlet for condenser and condenser coil discharge. These two areas must be sealed off from each other. If you experience poor cooling operation or erratic operation, check for air recirculation at condenser coil.
12. Replace access panels and reconnect electrical power.

Troubleshooting Sensors

1. See Figure 17 for location of sensor connections to the control board.
2. If temperature response of indoor or outdoor sensor is not correct, disconnect sensor from control board and verify sensor resistance. Replace sensor if its resistance is not close to values in the table below.

Table 2 - Sensor Resistance Values

@ Ambient Temperature	Resistance
77°F (25°C)	10.0 K
50°F (10°C)	19.9 K
35°F (1.6°C)	30.0 K
30°F (-1.1°C)	34.4 K

Figure 17 - Control Board Sensor Connections

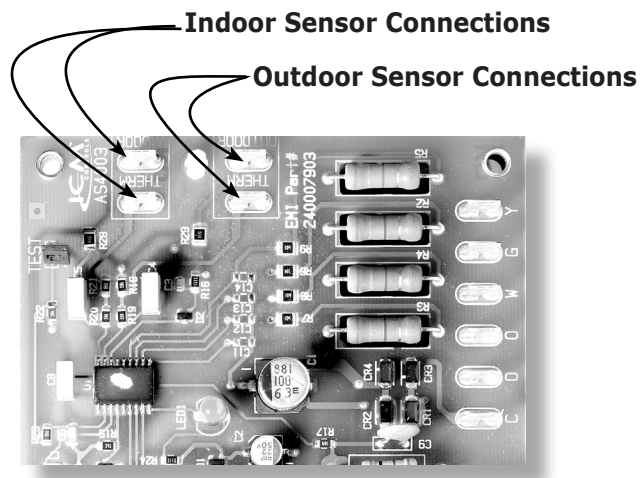

Figure 18 R40 Limit Switch Location

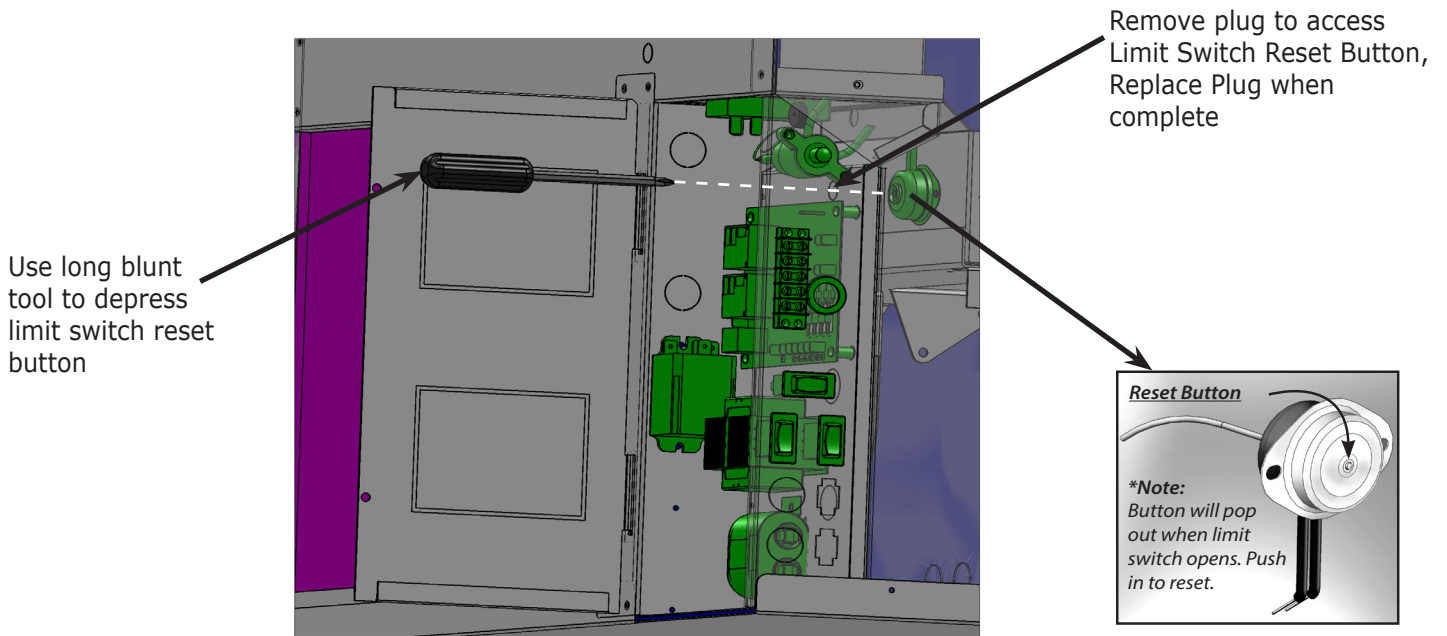
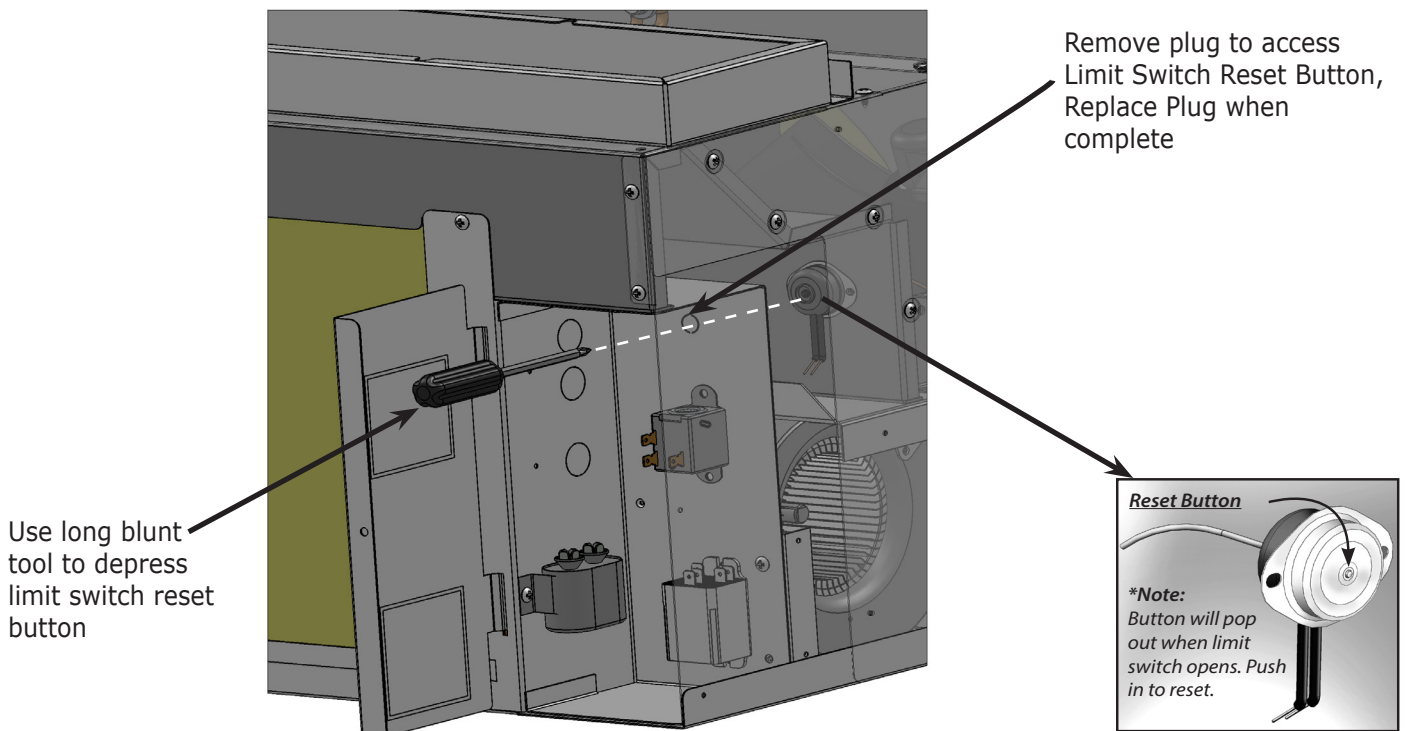

Figure 19 R41 Limit Switch Location



TROUBLESHOOTING

⚠️ **WARNING**

Electrical shock hazard. Disconnect power to unit before servicing or accessing control compartment. Failure To follow these instructions could result in death or serious injury.

NOTICE

Have qualified technician conduct troubleshooting procedures.

Symptom	Suggestion
No heat or cooling	<ul style="list-style-type: none"> • Check to see if unit has power and if thermostat is satisfied. If thermostat is not satisfied, call your installing contractor or service contractor.
Thermostat calls for cooling, but cool air is not coming out of unit.	<ul style="list-style-type: none"> • Check for continuity between thermostat and unit. Verify 24Vac is present across terminals C and R. • Verify high pressure switch located in outdoor section has not been tripped. If tripped, press switch button to restart compressor. • Note: If evaporator fan is operational and all of above suggested procedures have been followed, and there is still no cooling being supplied by unit, contact trained heating and cooling professional.
Light on circuit board is blinking.	<ul style="list-style-type: none"> • Circuit board uses light for diagnostic purposes. Blinking codes are as follows: <ul style="list-style-type: none"> – 1 blink = normal operation – 2 blinks = compressor lockout (ASCT – Anti-short cycle timer) – 3 blinks = outdoor freeze condition – 4 blinks = indoor freeze condition – 5 blinks = simultaneous Y and W call (Straight cool units only)
Circuit board light is blinking 3 or 4 times, but there is no freeze condition.	<ul style="list-style-type: none"> • Verify sensors have not been damaged. Remove sensor wires from control board and make resistance measurements, compare to following sensor resistances. Indoor and outdoor coil sensor wires are labeled, as is control board. <ul style="list-style-type: none"> – 77°F = 10KOhms – 50°F = 19.9KOhms – 35°F = 30KOhms – 30°F = 34.4KOhms
Thermostat is satisfied, but fan is still running.	<ul style="list-style-type: none"> • If thermostat is set to auto mode, once thermostat is satisfied, fan will stay energized for extra 60 seconds to purge unit of excess cool or warm air in plenum. • If thermostat fan switch is set to ON, fan will stay energized regardless of whether thermostat is satisfied or not. Only way to turn fan off is to turn unit off or turn thermostat fan switch to AUTO.
Thermostat calls for heat, but no heat comes out of unit.	<ul style="list-style-type: none"> • Units equipped with electric heaters have temperature limit switch to prevent electric heater from reaching unsafe temperatures. If after calling for heating, heater is not energized, check for continuity across limit. If limit is open, replace with equivalent limit switch.
Thermostat calls for heat while in heat pump mode, but heated air is not coming out of unit.	<ul style="list-style-type: none"> • Verify unit has power or thermostat has been satisfied. If unit has power and thermostat is satisfied, turn thermostat few degrees above room temperature. • While in heat pump mode, verify thermostat is not energizing O terminal. Retroaire units are designed to work in heat pump mode when 24Vac is present across Y and C. Verify heat pump jumper on control board is jumping two pins labeled "HP". See control board jumper locations, Figure 9, Page 17. • Verify there are no freeze conditions. Refer to blinking codes question above for more information.

R40C - PERFORMANCE DATA

Table 3 R40C Performance Data

Model R40	Cooling	Sensible Heat Ratio	EER	Indoor Air Flow
	Btuh (kW)			CFM (L/s)
R 40 C 09	9,000 (2.6)	0.7	8.98	350 (165)
R 40 C 12	10,800 (3.17)	0.6	8.6	350 (165)
R 40 C 15	13,200 (3.90)	0.6	8.09	350 (165)

Table 4 R40C - 9,000 BTU Electrical Specifications

Power Supply Volt 1-60		Compressor		Indoor Fan Motor		Outdoor Fan Motor		Electric Heat				Unit Electrical Ratings				
Volt	Min	RLA	LRA	FLA	Hp	FLA	Hp	Htr #	Volt	W	HA	TCA	THA	MCA	MOCP	Plug
115V	104	8.0	45.6	1.4	0.09	1.6	0.125	N/A	N/A	N/A	N/A	11	N/A	13.0	20	5-15P
208/ 230V	197	4.0	22.2	0.6	0.08	0.71	0.09	0	N/A	N/A	N/A	5.3	N/A	6.3	15	6-15P
								2	208	1636	7.9		8.5	10.6	15	6-15P
									230	2000	8.7		9.3	11.6		
								3	208	2454	11.8		12.4	15.5	20	6-20P
									230	3000	13		13.6	17.1		
								4	208	3271	15.7		16.3	20.4	25	6-30P
									230	4000	17.4		18	22.5		
								5	208	4089	19.7		20.3	25.3	30	6-30P
									230	5000	21.7		22.3	27.9		

Table 5 R40C - 12,000 BTU Electrical Specifications

Power Supply Volt 1-60		Compressor		Indoor Fan Motor		Outdoor Fan Motor		Electric Heat				Unit Electrical Ratings				
Volt	Min	RLA	LRA	FLA	Hp	FLA	Hp	Htr #	Volt	W	HA	TCA	THA	MCA	MOCP	Plug
115V	104	9.2	55	1.4	0.09	1.6	1.25	0	N/A	N/A	N/A	12.2	N/A	14.5	25	5-20P
208/ 230V	197	5.6	29	0.6	0.08	0.71	0.09	0	N/A	N/A	N/A	6.9	N/A	8.3	15	6-15P
								2	208	1636	7.9		8.5	10.6	15	6-15P
									230	2000	8.7		9.3	11.6		
								3	208	2454	11.8		12.4	15.5	20	6-20P
									230	3000	13		13.6	17.1		
								4	208	3271	15.7		16.3	20.4	25	6-30P
									230	4000	17.4		18	22.5		
								5	208	4089	19.7		20.3	25.3	30	6-30P
									230	5000	21.7		22.3	27.9		

Table 6 R40C - 15,000 BTU Electrical Specifications

Power Supply Volt 1-60		Compressor		Indoor Fan Motor		Outdoor Fan Motor		Electric Heat				Unit Electrical Ratings				
Volt	Min	RLA	LRA	FLA	Hp	FLA	Hp	Htr #	Volt	W	HA	TCA	THA	MCA	MOCP	Plug
208/ 230V	197	6.6	33	0.6	0.08	0.71	0.09	0	N/A	N/A	N/A	8.7	N/A	9.6	15	6-15P
								2	208	1636	7.9		8.5	10.6	15	6-15P
									230	2000	8.7		9.3	11.6		
								3	208	2454	11.8		12.4	15.5	20	6-20P
									230	3000	13		13.6	17.1		
								4	208	3271	15.7		16.3	20.4	25	6-30P
									230	4000	17.4		18	22.5		
								5	208	4089	19.7		20.3	25.3	30	6-30P
									230	5000	21.7		22.3	27.9		

R41C - PERFORMANCE DATA

















Table 7 R41C Performance Data

Model R40	Cooling	Sensible Heat Ratio	EER	Indoor Air Flow
	Btuh (kW)			CFM (L/s)
R 40 CA09	9,000 (2.6)	0.7	8.98	350 (165)

Table 8 R41C - 9,000 BTU Electrical Specifications

Power Supply Volt 1-60		Compressor		Indoor Fan Motor		Outdoor Fan Motor		Htr #	Electric Heat			Unit Electrical Ratings				
Volt	Min	RLA	LRA	FLA	Hp	FLA	Hp		Volt	W	HA	TCA	THA	MCA	MOCP	Plug
115V	104	7.5	47	1.4	0.09	1.6	0.125	5	115	1250	10.9	10.5	12.3	15.3	20	5-20P

LEGEND	
RLA	Rated Load Amps
FLA	Full Load Amps
Hp	Horse Power
W	Watts
HA	Heater Amps
TCA	Total Cooling Amps
THA	Total Heating Amps
MCA	Minimum Circuit Amps
MOCP	Maximum Over Current Protection

VOLTAGE	125V		250V			265V		
	15(A)	20(A)	15(A)	20(A)	30(A)	15(A)	20(A)	30(A)
PLUG	 5-15 P	 5-20 P	 6-15 P	 6-20 P	 6-30 P	 7-15 P	 7-20 P	 7-30 P
RECEPTACLE	 5-15 R	 5-20 R	 6-15 R	 6-20 R	 6-30 R	 7-15 R	 7-20 R	 7-30 R



LIMITED PRODUCT WARRANTY

RetroAire offers to the original purchaser/owner that under normal use and maintenance for comfort cooling and conditioning applications, all **RetroAire** equipment will be free from defects in material and workmanship for a period of 12 months from the documented date of original installation or 18 months from the date of manufacture, if the documented date of original installation is not available. Unit compressors shall be free from defects in materials and workmanship under normal use and maintenance for a period 60 months from the documented date of original installation or 66 months from the date of manufacture, if the documented date of original installation is not available.

WHAT RETROAIRE WILL WARRANT:

ECR will provide a replacement for or, at the discretion of **RetroAire**, repair any functional component that proves to be defective in material or workmanship, under normal maintenance and operating conditions, within the prescribed warranty period. Said parts will be supplied via standard shipping; billed and then credited back, when the defective component is returned, at the sole discretion of **RetroAire**. However, the replacement cost shall NOT include labor or service costs to diagnose, remove, or install a warranty part, or return of defective materials, at the sole discretion of **RetroAire**.

WHAT RETROAIRE WILL NOT WARRANT:

Damages to or arising from: misapplication, improper installation or service; components not supplied or approved by **RetroAire**, including, without limitation, cabinetry, wall sleeves, louvers, internal components, equipment, or controls supplied by others; and lack of preventative maintenance such as, but not limited to, replacing air filters, general cleaning, clearing condensate drains, air flow adjustments; products manufactured or distributed by **RetroAire** but installed outside the United States and Canada; unauthorized alteration, application or improper operation; excessively corrosive installation environments; equipment usage during construction; shipping or handling.

RETROAIRE IS ALSO NOT RESPONSIBLE FOR:

Damages caused by faulty or interrupted power supply or electrical service; Damages caused by acts of God including, but not limited to, wind, hail, floods, lightning, earthquakes or other conditions beyond the control of **RetroAire**.

FURTHER LIMITATIONS:

All implied warranties of merchantability and/or fitness for any particular purpose are limited in duration to the period of the limited warranty. The rights and remedies provided herein are exclusive and constitute the entire contract. This limited warranty and any optional extended warranties are granted only to the original owner/user. This warranty becomes null and void if payment for the goods or product is in default. Warranty remedies may be withheld if the customer account is in arrears or default.

In no event shall RetroAire be liable (whether for breach of this limited warranty or contract, for strict liability for negligence, or otherwise), for any special, incidental, punitive or consequential damages, including, without limitation, damages for loss of profits, loss of goodwill, loss of time or convenience, loss of use of the product, the cost of a product rental, costs of gasoline, electricity, telephone, travel or lodging, or the loss of personal or commercial property, whether or not RetroAire has been advised of the possibility of any such damages.

In no event shall RetroAire's obligations under this limited warranty exceed the purchase price of the product.

Any repairs performed under this limited warranty shall not in any way extend the statute of limitations for claims under this limited warranty.

No agent, representative or distributor of RetroAire has any authority to alter the terms of this limited warranty in any way.

For Service or Repair:

- 1) Contact the installing contractor
- 2) Call the nearest RetroAire sales rep/distributor
- 3) Call, E-Mail or write:

RetroAire, c/o ECR International, Inc., 2201 Dwyer Avenue, Utica, NY 13501, Ph: 1-800-325-5479
Fax: 1-866-432-7329, E-Mail: info@RetroAire.com, Web: www.RetroAire.com.

RETROAIRE™

The Right Fit for Comfort



ECR International, Inc.

2201 Dwyer Avenue • Utica, New York 13501

Phone: 1.800.325.5279 • Web: retroaire.com
