



## Models

**UBSSC-050**  
**UBSSC-075**  
**UBSSC-100**  
**UBSSC-150**  
**UBSSC-200**  
**UBSSC-299**

**WALL MOUNTED  
GAS BOILER**

**PARTS, KITS &  
OPTIONAL ACCESSORIES**

### Ordering Instructions

Order Parts through your nearest supplier.

When ordering parts, obtain Model Number and Serial Number from data plate on your boiler.

Include following information when ordering.

Part Number \_\_\_\_\_

Part Description \_\_\_\_\_

Boiler Model Number \_\_\_\_\_

Boiler Serial Number \_\_\_\_\_



**Manufactured by:**  
ECR International Inc.  
2201 Dwyer Avenue, Utica, NY 13501  
Tel. 800 253 7900  
[www.ecrinternational.com](http://www.ecrinternational.com)  
PN 240011322 REV. E [03/31/2018]

## TABLE OF CONTENTS

Additional Heating Device Kit .....	23
Air Filter Kit - 299 .....	22
Blower Kit - 050/075/100/150/200 MBH.....	12
Blower Kit - 299 MBH.....	13
Burner Inspection Kit .....	6
Burner Replacement Kits .....	6
Concentric Vent Kits.....	23
Condensate Collector Kit 050/075/100 .....	16
Condensate Collector Kit 150/200.....	17
Condensate Trap Kits .....	15
Control Module Kit.....	18
Flame Sensor Kits.....	9
Flexible Gas Line Kits .....	14
Floor Stand Kit .....	22
Gas Conversion Kits.....	21
Gas Valve Kit - 299 MBH.....	11
Gas Valve Kits - 050/075/100/150/200 MBH .....	10
Heat Exchanger Kits.....	4
Heat Exchanger Kits.....	5
Heat Exchanger Surface Temperature Switch Kits.....	20
High Altitude Kit .....	22
Igniter Kits .....	8
Jacket Kits.....	3
Misc. Replacement Parts.....	24
Misc. Replacement Parts - Conti.....	25
Multi Boiler Sensor Kit .....	23
User Interface Kit .....	18
Wire Harness Kits .....	19
<b>QUICK INDEX .....</b>	<b>26</b>

## JACKET KITS

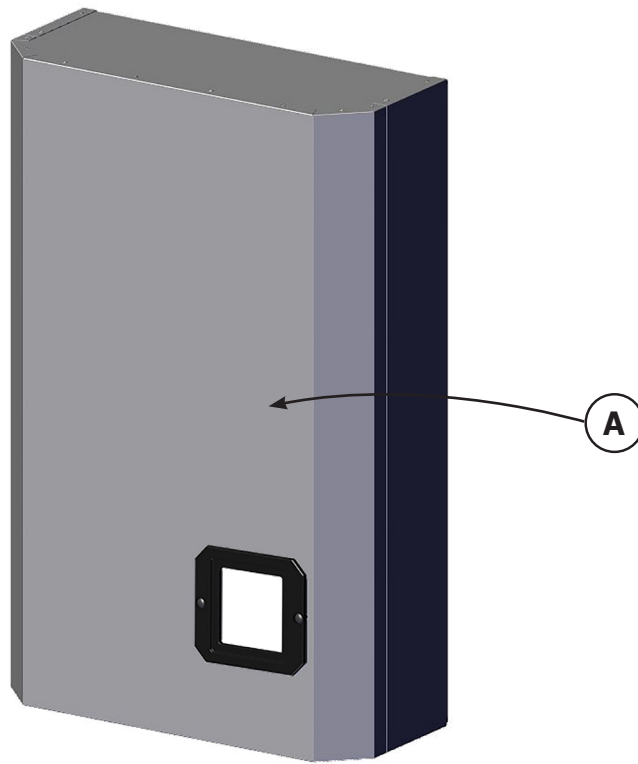

<b>50-100 Jacket Kit # 550003135</b>			
Item	DESCRIPTION	PART #	QTY
A	Jacket with Bezel, Gasket and Hook and Latch	-	1

<b>150-200 Jacket Kit # 550003138</b>			
Item	DESCRIPTION	PART #	QTY
A	Jacket with Bezel, Gasket and Hook and Latch	-	1

<b>299 Jacket Kit # 550003141</b>			
Item	DESCRIPTION	PART #	QTY
A	Jacket with Bezel, Gasket and Hook and Latch	-	1

# HEAT EXCHANGER KITS

Heat Exchanger 050, 075, 100, 150, 200 MBH

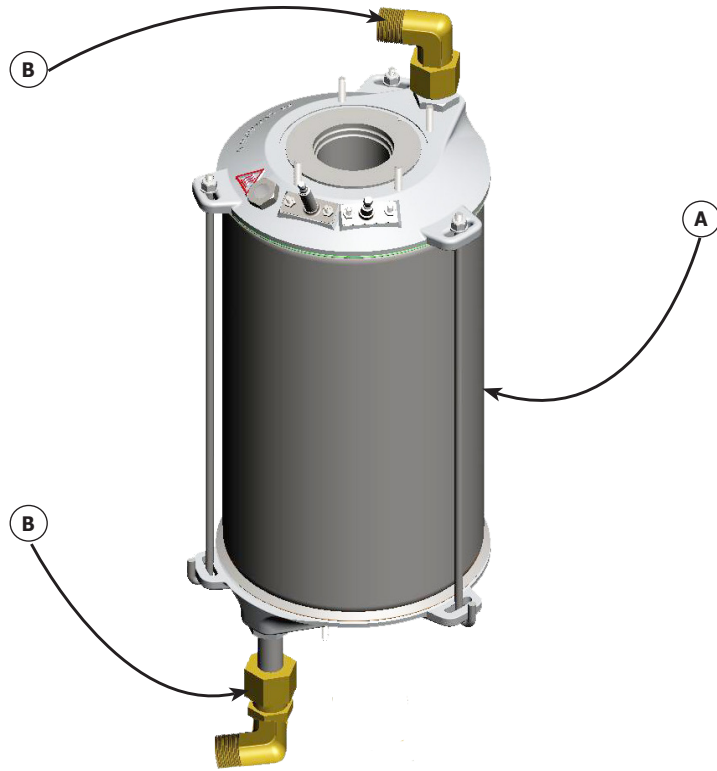

Heat Exchanger with Integrated Flue Collector - 299 MBH

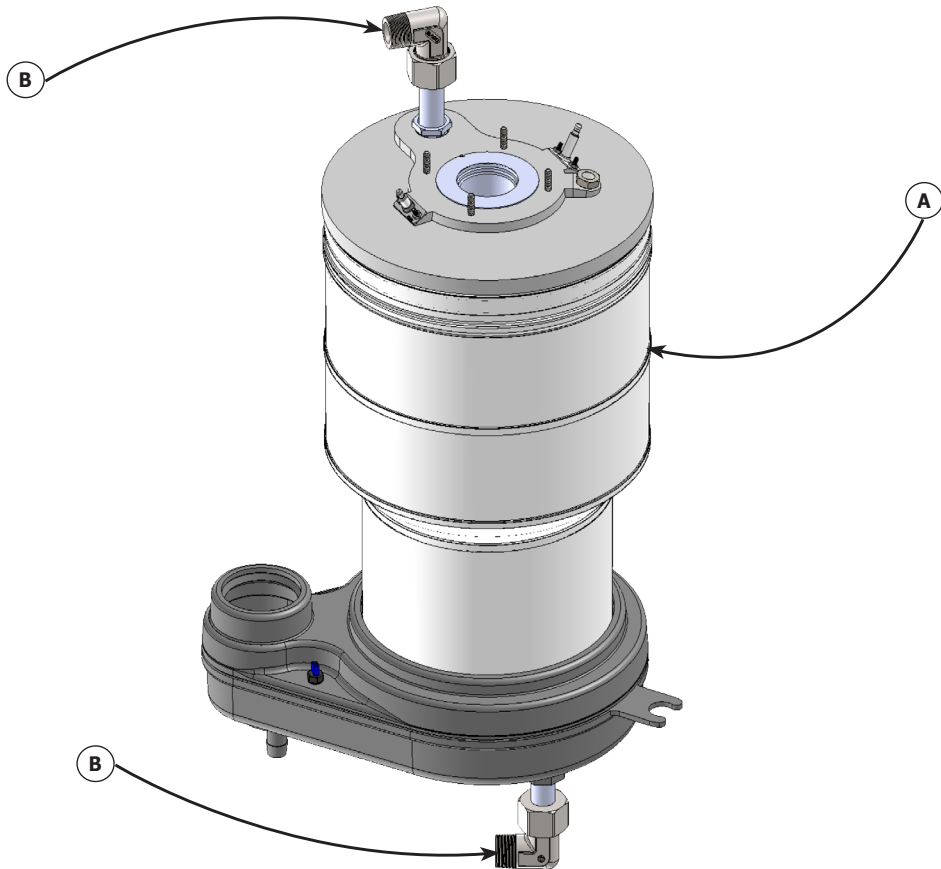

## HEAT EXCHANGER KITS

<b>050 Heat Exchanger Kit # 550002271</b>				
Heat Exchanger Kit #550002271 includes all items listed	ITEM	DESCRIPTION	PART #	QTY
	A	Heat Exchanger Module (includes: Igniter, Flame Sensor)	-	1
	B	Fitting, Compression 90°, 20 mm tube x 3/4 NPT	-	2
	*	Instructions	240008928	1
<b>075 Heat Exchanger Kit # 550002272</b>				
	A	Heat Exchanger Module (includes: Igniter, Flame Sensor)	-	1
	B	Fitting, Compression 90°, 20 mm tube x 3/4 NPT	-	2
	*	Instructions	240008928	1
<b>100 Heat Exchanger Kit # 550002273</b>				
	A	Heat Exchanger Module (includes: Igniter, Flame Sensor)	-	1
	B	Fitting, Compression 90°, 20 mm tube x 3/4 NPT	-	2
	*	Instructions	240008928	1
<b>150 Heat Exchanger Kit # 550002274</b>				
Heat Exchanger Kit #550002274 includes all items listed	ITEM	DESCRIPTION	PART #	QTY
	A	Heat Exchanger Module (includes: Igniter, Flame Sensor)	-	1
	B	Fitting, Compression 90°, 25 mm tube x 1 NPT	-	2
	*	Instructions	240008928	1
<b>200 Heat Exchanger Kit # 550002275</b>				
	A	Heat Exchanger Module (includes: Igniter, Flame Sensor)	-	1
	B	Fitting, Compression 90°, 25 mm tube x 1 NPT	-	2
	*	Instructions	240008928	1
<b>299 Heat Exchanger Kit # 550002808</b>				
	A	Heat Exchanger Module (includes: Heat Exchanger Coil, Top Cap, Igniter, Flame Sensor with Flue Collector Installed)	-	1
	B	Fitting, Compression 90°, 25 mm tube x 1 NPT	-	2
	*	Instructions	240010108	1
* Not Shown				

## BURNER REPLACEMENT KITS

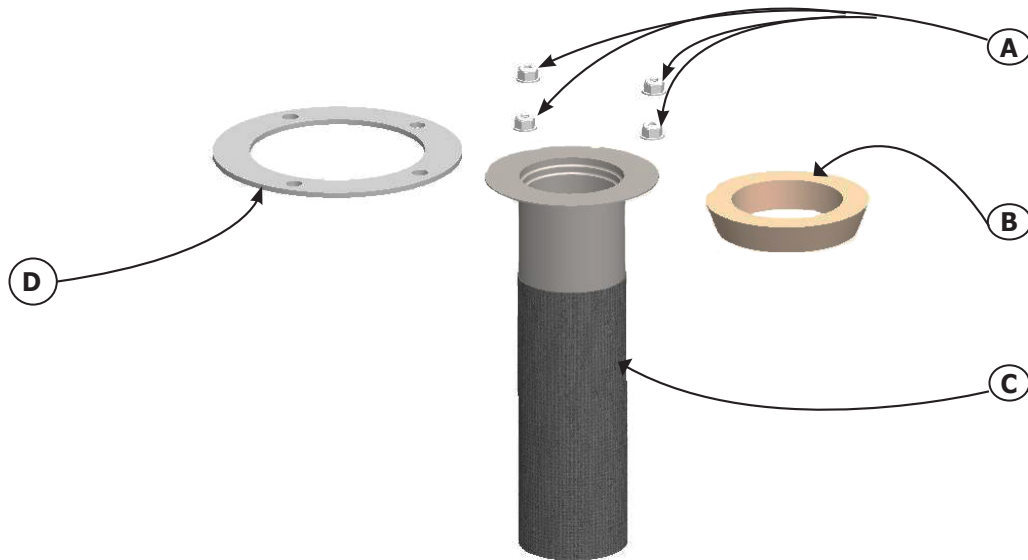

50/075/100/150/200 Burner Inspection Kit # 550002280				
	ITEM	DESCRIPTION	PART #	QTY
Replacement Inspection Kit #550002280 includes all items listed	A	1/4-20 Nut	-	8
	B	Burner Sleeve, Refractory	-	1
	D	Gasket, Air/Fuel Inlet	-	1
	*	Fiber Gasket	-	1
	*	Igniter Gasket	-	1
	*	8-32 Hex Nut	-	4
	*	Instructions		240008931
299 Burner Inspection Kit # 550002818				
	ITEM	DESCRIPTION	PART #	QTY
Replacement Inspection Kit #550002818 includes all items listed	A	1/4-20 Nut	-	8
	B	Burner Sleeve, Refractory	-	1
	D	Gasket, Air/Fuel Inlet	-	1
	*	Fiber Gasket	-	1
	*	Igniter Gasket	-	1
	*	8-32 Hex Nut	-	4
	*	Instructions		240010107
* Not Shown				
050 Replacement Burner Kit # 550002276				
	ITEM	DESCRIPTION	PART #	QTY
Replacement Burner Kit #550002276 includes all items listed	A	1/4-20 Nut	-	4
	B	Burner Sleeve, Refractory	-	1
	C	Burner 50K BTU	-	1
	D	Fiber Gasket	-	1
	*	Igniter Gasket	-	1
	*	8-32 Hex Nut	-	2
	*	Instructions		240008933

## BURNER REPLACEMENT KITS

### Burner Replacement Kits - Conti.

<b>075 Replacement Burner Kit # 550002277</b>				
Replacement Burner Kit #550002277 includes all items listed	<b>A</b>	1/4-20 Nut	-	4
	<b>B</b>	Burner Sleeve, Refractory	-	1
	<b>C</b>	Burner 75K BTU	-	1
	<b>D</b>	Fiber Gasket	-	1
	<b>*</b>	Igniter Gasket	-	1
	<b>*</b>	8-32 Hex Nut	-	2
	<b>*</b>	Instructions	240008933	1
<b>100 Replacement Burner Kit # 550002278</b>				
Replacement Burner Kit #550002278 includes all items listed	<b>A</b>	1/4-20 Nut	-	4
	<b>B</b>	Burner Sleeve, Refractory	-	1
	<b>C</b>	Burner 100K BTU	-	1
	<b>D</b>	Fiber Gasket	-	1
	<b>*</b>	Igniter Gasket	-	1
	<b>*</b>	8-32 Hex Nut	-	2
	<b>*</b>	Instructions	240008933	1
<b>150/200 Replacement Burner Kit # 550002279</b>				
Replacement Burner Kit #550002279 includes all items listed	<b>A</b>	1/4-20 Nut	-	4
	<b>B</b>	Burner Sleeve, Refractory	-	1
	<b>C</b>	Burner 150K BTU	-	1
	<b>D</b>	Fiber Gasket	-	1
	<b>*</b>	Igniter Gasket	-	1
	<b>*</b>	8-32 Hex Nut	-	2
	<b>*</b>	Instructions	240008933	1
<b>299 Replacement Burner Kit # 550002809</b>				
Replacement Burner Kit #550002809 includes all items listed	<b>A</b>	1/4-20 Nut	-	4
	<b>B</b>	Burner Sleeve, Refractory 299 MBH	-	1
	<b>C</b>	Burner 299K BTU	-	1
	<b>D</b>	Fiber Gasket	-	1
	<b>*</b>	Igniter Gasket	-	1
	<b>*</b>	8-32 Hex Nut	-	2
	<b>*</b>	Instructions	240010106	1

## IGNITER KITS



<b>050/075/100 Igniter Kit # 550002190</b>				
	ITEM	DESCRIPTION	PART #	QTY
Igniter Kit #550002190 includes all items listed	A	8-32, Hex Nut	-	2
	B	Igniter	-	1
	C	Igniter Gasket	-	1
	*	Instructions	240008592	1
<b>150/200/299 Igniter Kit # 550002282</b>				
	ITEM	DESCRIPTION	PART #	QTY
Igniter Kit #550002282 includes all items listed	A	8-32 Hex Nut	-	2
	B	Igniter	-	1
	C	Igniter Gasket	-	1
	*	Instructions	240008592	1
* Not Shown				



## FLAME SENSOR KITS

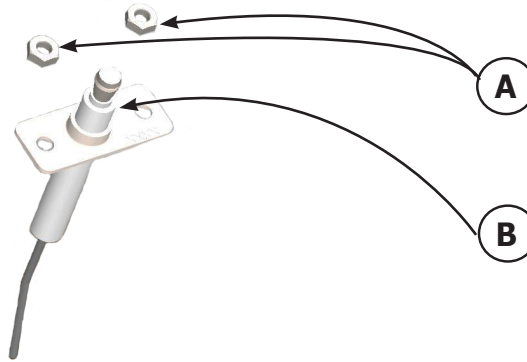

<b>050/075/100 Flame Sensor Kit #550002283</b>				
Flame Rod Kit #550002283 includes all items listed	ITEM	DESCRIPTION	PART #	QTY
	A	8-32 Hex Nut	-	2
	B	Sensor Flame	-	1
	*	Instructions	240008593	1
<b>150/200 Flame Sensor Kit #550002284</b>				
Flame Rod Kit #550002284 includes all items listed	ITEM	DESCRIPTION	PART #	QTY
	A	8-32 Hex Nut	-	2
	B	Sensor Flame	-	1
	*	Instructions	240008593	1
<b>299 Flame Sensor Kit #550002810</b>				
Flame Rod Kit #550002810 includes all items listed	ITEM	DESCRIPTION	PART #	QTY
	A	8-32 Hex Nut	-	2
	B	Sensor Flame 299 MBH	-	1
	*	Instructions	240008593	1
* Not Shown				

## GAS VALVE KITS - 050/075/100/150/200 MBH

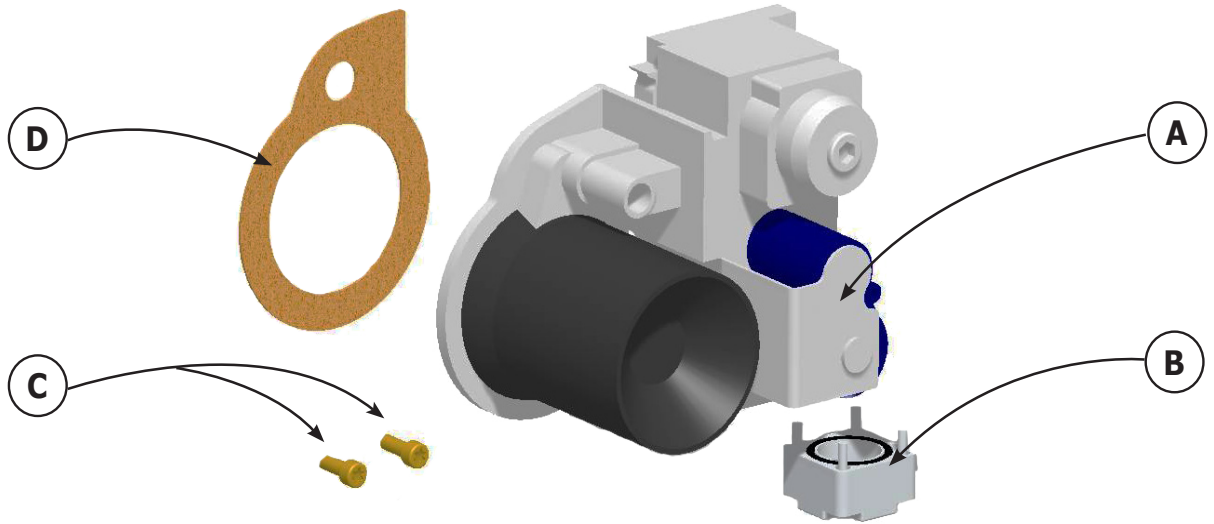

<b>050 Gas Valve Kit # 550002329</b>				
Gas Valve Kit #550002329 includes all items listed	A	Gas Valve, 050, VK4115V, Venturi included	-	1
	B	Gas Valve Flange Kit	1235008	1
	C	Screw, T25 Torx	-	2
	D	Gasket, Cork	1250021	1
	*	Instructions	240008939	1
<b>075 Gas Valve Kit # 550002285</b>				
Gas Valve Kit #550002285 includes all items listed	A	Gas Valve, 075, VK4115V, Venturi included	-	1
	B	Gas Valve Flange Kit	1235008	1
	C	Screw, T25 Torx	-	2
	D	Gasket, Cork	1250021	1
	*	Instructions	240008939	1
<b>100 Gas Valve Kit # 550002286</b>				
Gas Valve Kit #550002286 includes all items listed	A	Gas Valve, 100, VK4115V, Venturi included	-	1
	B	Gas Valve Flange Kit	1235008	1
	C	Screw, T25 Torx	-	2
	D	Gasket, Cork	1250021	1
	*	Instructions	240008939	1
<b>150 Gas Valve Kit # 550002287</b>				
Gas Valve Kit #550002287 includes all items listed	A	Gas Valve, 150, VK4115F, Venturi included	-	1
	B	Gas Valve Flange Kit	1235008	1
	C	Screw, T25 Torx	-	2
	D	Gasket, Cork	1250021	1
	*	Instructions	240008939	1
<b>200 Gas Valve Kit # 550002288</b>				
Gas Valve Kit #550002288 includes all items listed	A	Gas Valve, 200, VK4115F, Venturi included	-	1
	B	Gas Valve Flange Kit	1235008	1
	C	Screw, T25 Torx	-	2
	D	Gasket, Cork	1250021	1
	*	Instructions	240008939	1
* Not Shown				

## GAS VALVE KIT - 299 MBH

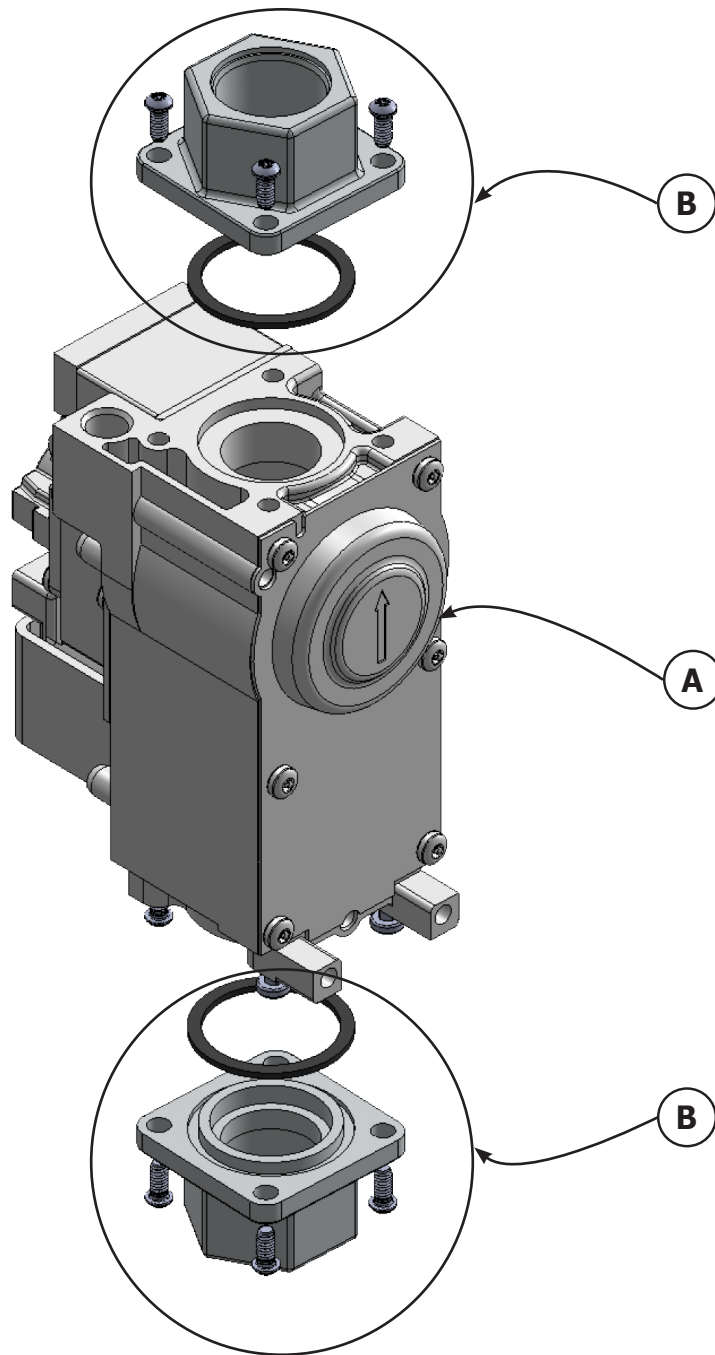

<b>299 Gas Valve Kit # 55002811</b>				
Gas Valve Kit #55002811 includes all items listed	A	Gas Valve, 299, VR4615	-	1
	B	Gas Valve Flange Kit	-	1
	*	Instructions	240010104	1
* Not Shown				

## BLOWER KIT - 050/075/100/150/200 MBH

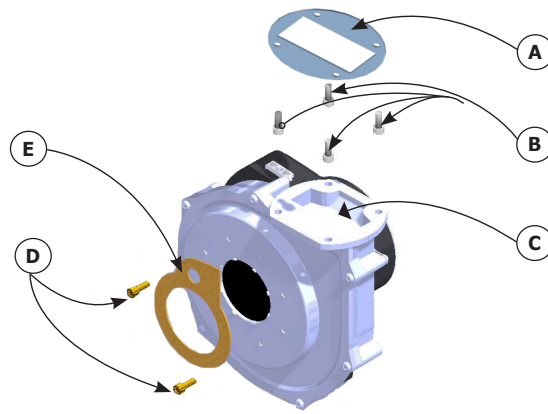

<b>050/075/100 Blower Kit # 550002291</b>				
	ITEM	DESCRIPTION	PART #	QTY
Blower Motor Kit #550002291 includes all items listed	A	Gasket, Fan/Transition Piece	240011291	1
	B	Screw,10-24 X 1/2" Socket Head Cap	-	4
	C	Blower, 120 V 50/60 HZ, RG130/0800-3612	-	1
	D	Screw, T25 Torx	-	4
	E	Gasket, Cork	1250021	1
	*	1/4-20 Hex Flange Nut	-	4
	*	Instructions	240008943	1
<b>150 Blower Kit # 550002292</b>				
Blower Motor Kit #550002292 includes all items listed	A	Gasket, Fan/Transition Piece	240011291	1
	B	Screw,10-24 X 1/2" Socket Head Cap	-	4
	C	Blower, 120 V 50/60 HZ, RG148/1200-3612	-	1
	D	Screw, T25 Torx	-	4
	E	Gasket, Cork	1250021	1
	*	1/4-20 Hex Flange Nut	-	4
	*	Instructions	240008943	1
<b>200 Blower Kit # 550002293</b>				
Blower Motor Kit #550002293 includes all items listed	A	Gasket, Fan/Transition Piece	240011291	1
	B	Screw,10-24 X 1/2" SS Socket Head Cap	-	4
	C	Blower, 120 V 50/60 HZ, RG148/1200-3633	-	1
	D	Screw, T25 Torx	-	4
	E	Gasket, Cork	1250021	1
	*	1/4-20 Hex Flange Nut	-	4
	*	Instructions	240008943	1
<b>200 Blower Kit # 550003058 - High Altitude</b>				
Blower Motor Kit #550003058 includes all items listed	A	Gasket, Fan/Transition Piece	-240011291	1
	B	Screw,10-24 X 1/2" SS Socket Head Cap	-	4
	C	Blower, 120 V 50/60 HZ,130 W RG148/1200-3633	-	1
	D	Screw, T25 Torx	-	4
	E	Gasket, Cork	1250021	1
	*	1/4-20 Hex Flange Nut	-	4
	*	Instructions	240008943	1
* Not Shown				

## BLOWER KIT - 299 MBH

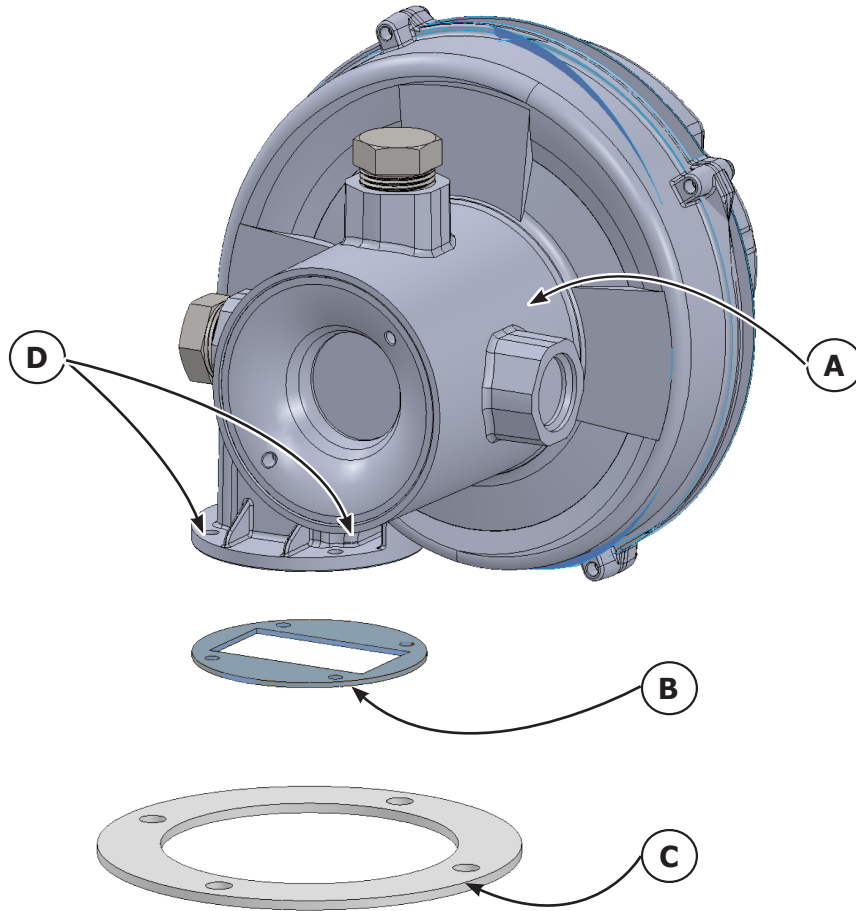

<b>299 Blower Kit # 550002812</b>				
	ITEM	DESCRIPTION	PART #	QTY
Blower Motor Kit #550002812 includes all items listed	A	Blower, 120 V 50/60 HZ, NRG137, Venturi Integrated	-	1
	B	Gasket, Fan/Transition Piece	240011291	1
	C	Fibert Gasket	240009969	1
	D	1/4-20 Hex Flange Nut	-	4
	*	Instructions	240010105	1

## FLEXIBLE GAS LINE KITS

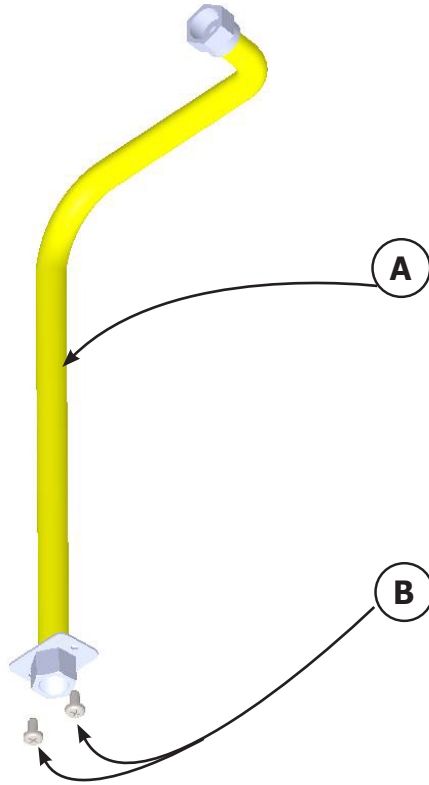

<b>050/075/100 Flexible Gas Line Kit # 550002289</b>				
Flexible Gas Line Kit #550002289 includes all items listed	ITEM	DESCRIPTION	PART #	QTY
	A	Flexible Gas Line 23½"	-	1
	B	Screw, 12-24x1/2 Type F	-	2
	*	Instructions	240008941	1
<b>150/200 Flexible Gas Line Kit # 550002290</b>				
Flexible Gas Line Kit #550002290 includes all items listed	A	Flexible Gas Line 28"	-	1
	B	Screw, 12-24x1/2 Type F	-	2
	*	Instructions	240008941	1
<b>299 Flexible Gas Line Kit # 550002813</b>				
Flexible Gas Line Kit #550002813 includes all items listed	A	Flexible Gas Line 15"	-	1
	B	Screw, 12-24x1/2 Type F	-	2
	*	Instructions	240008941	1
* Not Shown				

# CONDENSATE TRAP KITS

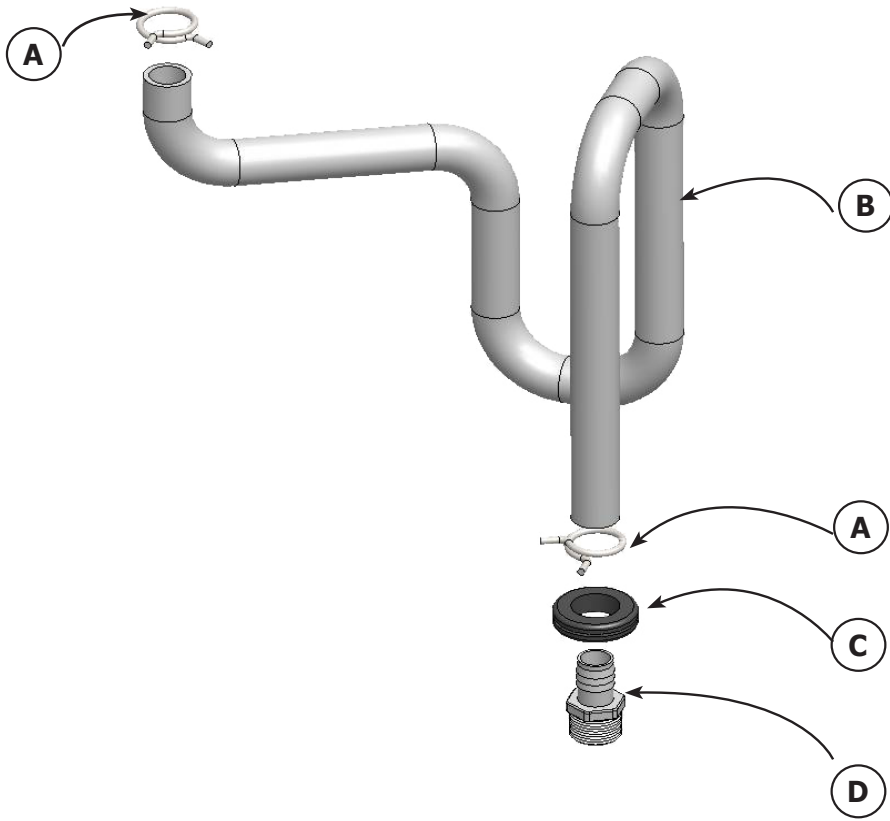

<b>050/075/100 Condensate Trap Kit # 550002296</b>				
	ITEM	DESCRIPTION	PART #	QTY
Condensate Trap Kit #550002296 includes all items listed	A	Collet Clip, 1-1/8"	240008406	2
	B	Condensate Trap	-	1
	C	Grommet, Heyco 1" ID x 1.75" OD	-	1
	D	Coupling, Barbed 3/4"	-	1
	*	Instructions	240008948	1
<b>150/200 Condensate Trap Kit #550002297</b>				
Condensate Trap Kit #550002297 includes all items listed	A	Collet Clip, 1-1/8"	240008406	2
	B	Condensate Trap	-	1
	C	Grommet, Heyco 1" ID x 1.75" OD	-	1
	D	Coupling, Barbed 3/4"	-	1
	*	Instructions	240008948	1
<b>299 Condensate Trap Kit #550002814</b>				
Condensate Trap Kit #55000xxxx includes all items listed	A	Collet Clip, 1-1/8"	240008406	2
	B	Condensate Trap	-	1
	C	Grommet, Heyco 1" ID x 1.75" OD	-	1
	D	Coupling, Barbed 3/4"	-	1
	*	Instructions	240008948	1
* Not Shown				

## CONDENSATE COLLECTOR KIT 050/075/100

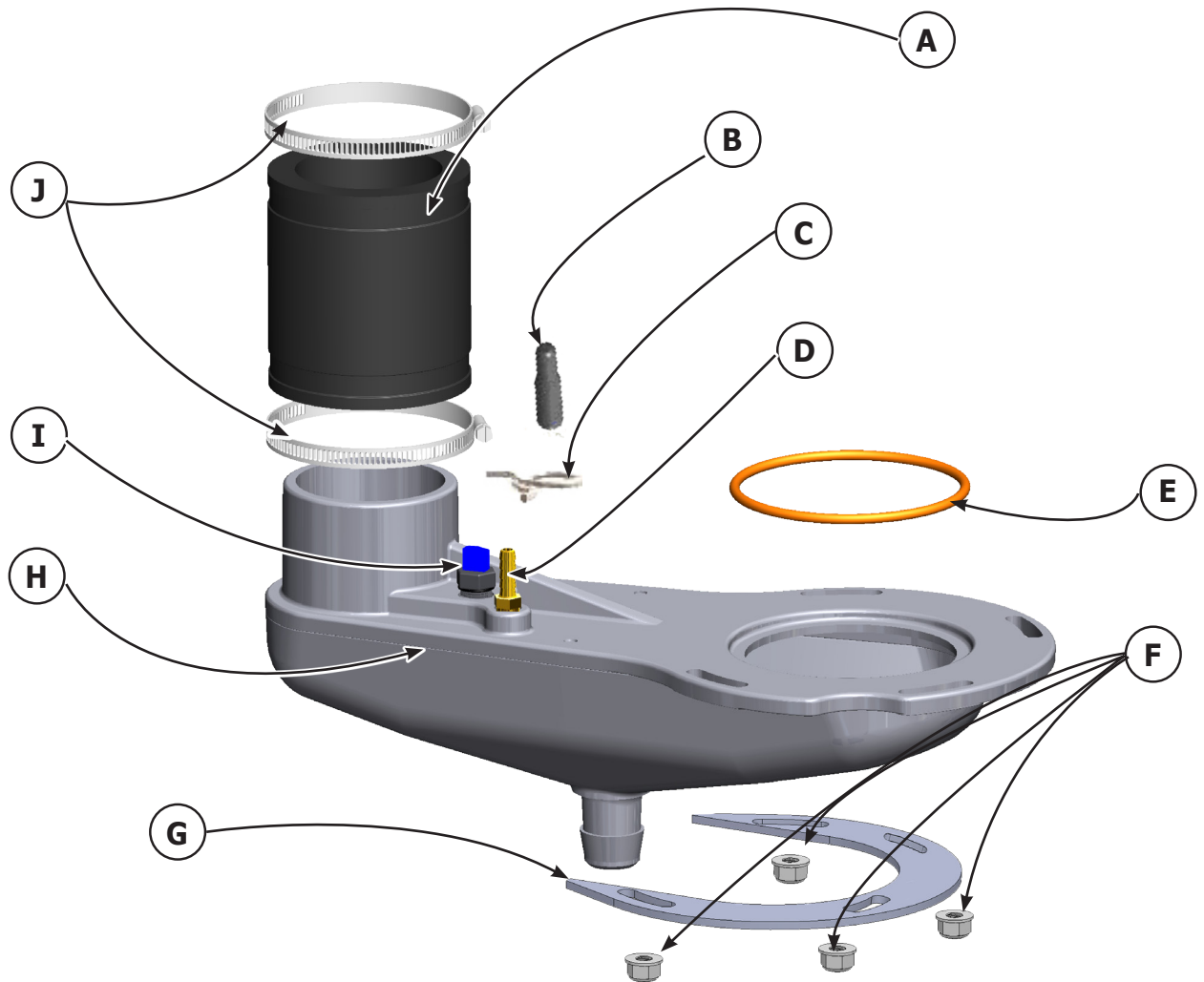

<b>050/075/100 Condensate Collector Kit # 550002294</b>				
	ITEM	DESCRIPTION	PART #	QTY
Condensate Collector Kit #550002294 includes all items listed	A	Flexible Coupling	-	1
	B	Cap black vinyl 3/16"	1230006	1
	C	Clamp, Spring Tension	1110001	1
	D	Hose Barb	1230010	1
	E	O-Ring for Condensate Collector	240008261	1
	F	1/4-20 Hex Flange Nut	-	4
	G	Flue Collector Bracket	109008777	1
	H	Condensate Collector Plastic	-	1
	I	Sensor, Vent Temperature	240008227	1
	J	Hose Clamp	-	2
	*	Instructions	240008946	1

\* Not Shown



## CONDENSATE COLLECTOR KIT 150/200

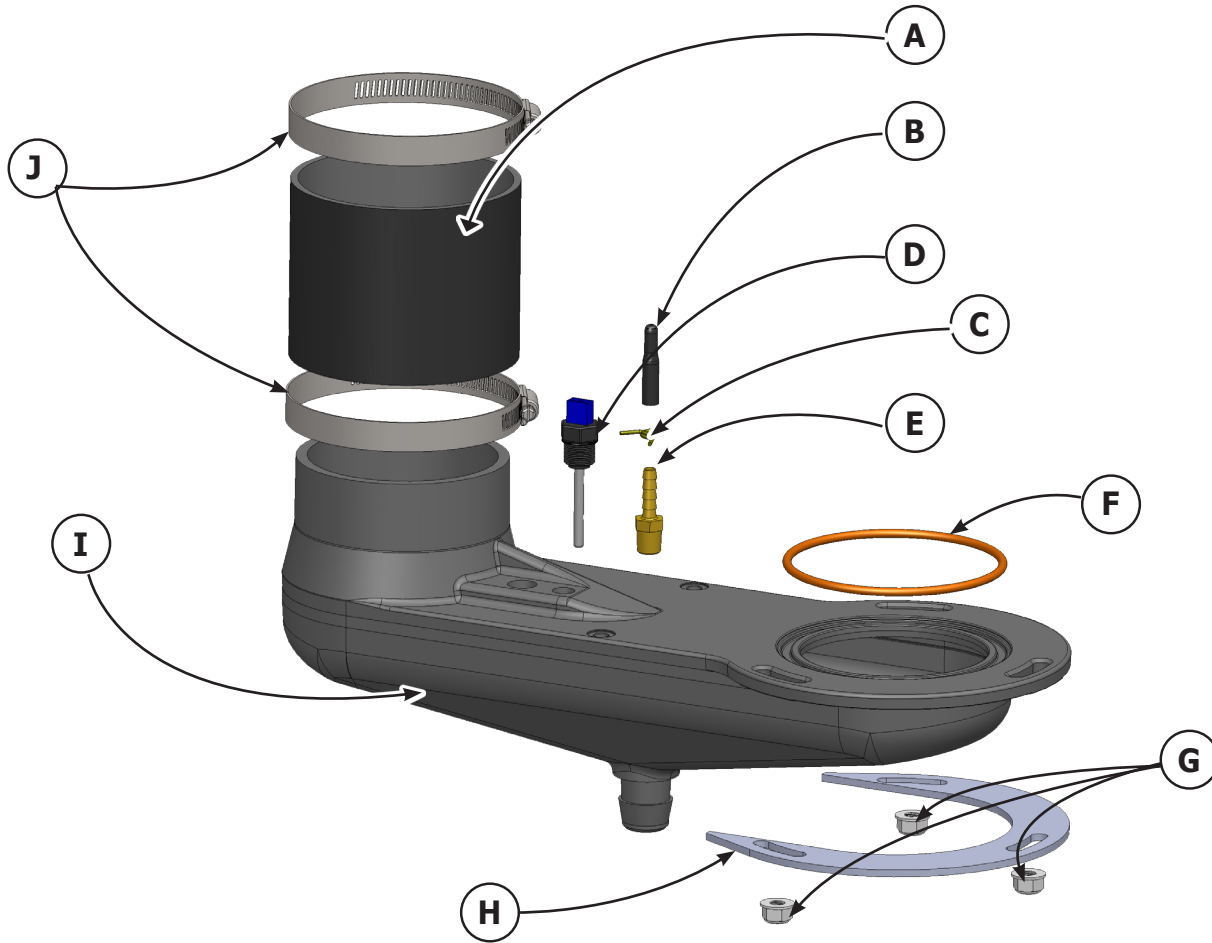

<b>150/200 Condensate Collector Kit # 550002295</b>				
	ITEM	DESCRIPTION	PART #	QTY
Condensate Collector Kit #550002295 includes all items listed	A	Flexible Coupling	-	1
	B	Cap black vinyl 3/16"	1230006	1
	C	Clamp, Spring Tension	1110001	1
	D	Sensor, Vent Temperature	240008227	1
	E	Hose Barb	1230010	1
	F	O-Ring for Condensate Collector	240010288	1
	G	1/4-20 Hex Flange Nut	-	3
	H	Flue Collector Bracket	109008776	1
	I	Condensate Collector Plastic	-	1
	J	Hose Clamp	-	2
	*	Instructions	240008946	1

\* Not Shown

**NOTE: 299 CONDENSATE COLLECTOR SOLD WITH HEAT EXCHANGER (SEE PAGES 4 & 5)**

## CONTROL MODULE KIT

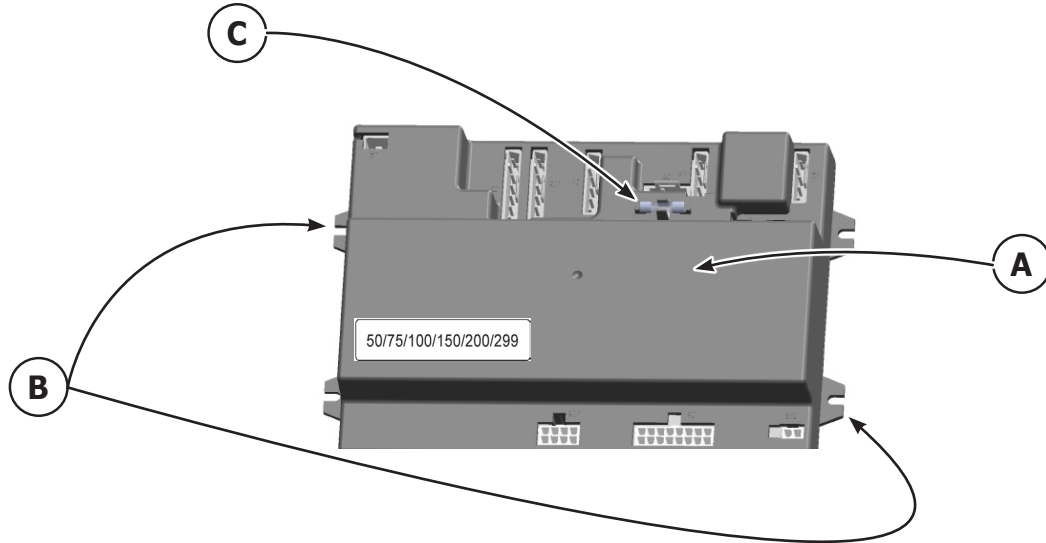

### 050/075/100/150/200/299 Control Module Kit # 550002583

	ITEM	DESCRIPTION	PART #	QTY
Control Board Kit #550002298 includes all items listed	A	Control Module	-	1
	B	Screw, 8-32x3/8, HWH, Slot Self Tapping	-	4
	C	Fuse, 3.15A ac, 250V, Slo-Blo Glass 5x20mm (Additional fuse is included with control module on Boiler)	240008665	1
	*	Instructions	240009314	1

\* Not Shown

**NOTE: IF BOILER HAS BEEN CONVERTED TO HIGH ALTITUDE - REPLACE EXISTING CONTROL WITH HIGH ALTITUDE KIT ONLY. SEE PAGE 25.**

## USER INTERFACE KIT

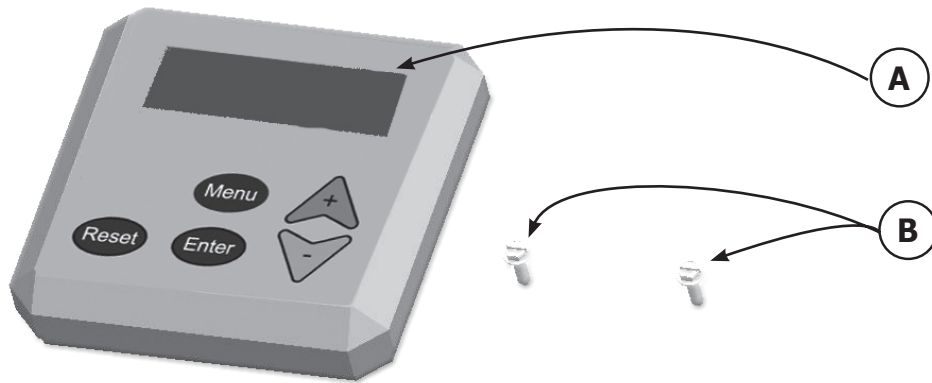

### 050/075/100/150/200/299 User Interface Kit # 550002299

	ITEM	DESCRIPTION	PART #	QTY
User Interface Kit #550002299 includes all items listed	A	User Interface Control	-	1
	B	Screw, 8-32 x 1/2" Type B	-	2
	*	Instructions	240008930	1

\* Not Shown

## WIRE HARNESS KITS

<b>050/075/100 Wire Harness Kit #550003200</b>			
	DESCRIPTION	PART #	QTY
Wire Harness Kit #550003200 includes all items listed	Main Boiler Wiring Assembly Harness 50/75/100	-	1
	User Interface Wire Harness	-	1
	Strain Relief Bushing	-	1
	Low Voltage Terminal Block Clip	-	5
	Screw, 8-32x5/16, Self Tapping, Ground, Green	-	1
	Instructions	240011560	1

<b>150/200 Wire Harness Kit # 550003201</b>			
	DESCRIPTION	PART #	QTY
Wire Harness Kit #550003201 includes all items listed	Main Boiler Wiring Assembly Harness 150/200	-	1
	User Interface Wiring Harness	-	1
	Strain Relief Cord Grip	-	1
	Low Voltage Terminal Block Clip	-	5
	Screw, 8-32x5/16, Self Tapping, Ground, Green	-	1
	Instructions	240011560	1

<b>299 Wire Harness Kit # 550003202</b>			
	DESCRIPTION	PART #	QTY
Wire Harness Kit #550003202 includes all items listed	Main Boiler Wiring Assembly Harness 299	-	1
	User Interface Wiring Harness	-	1
	Strain Relief Cord Grip	-	1
	Strain Relief Nut	-	1
	Low Voltage Terminal Block Clip	-	5
	Screw, 8-32x5/16, Self Tapping, Ground, Green	-	1
	Instructions	240011560	1

## HEAT EXCHANGER SURFACE TEMPERATURE SWITCH KITS

<b>Heat Exchanger Surface Temperature Switch 50/75/100 Kit #550002554</b>			
	DESCRIPTION	PART #	QTY
Wire Harness Kit #550002554 includes all items listed	Temperature Switch Bracket 50/75/100	-	1
	Temperature Switch L300-40F	240009508	1
	Wire Harness, Temperature Switch	-	1
	Instructions	240009568	1
<b>Heat Exchanger Surface Temperature Switch 150/200 Kit #550002555</b>			
Wire Harness Kit #550002555 includes all items listed	Temperature Switch Bracket 150/200	-	1
	Temperature Switch L300-40F	240009508	1
	Wire Harness, Temperature Switch	-	1
	Instructions	240009568	1
<b>Heat Exchanger Surface Temperature Switch 299 Kit #550002820</b>			
Wire Harness Kit #550002820 includes all items listed	Temperature Switch Bracket 299	-	1
	Temperature Switch L300-40F	240009508	1
	Wire Harness, Temperature Switch	-	1
	Instructions	240009568	1

## GAS CONVERSION KITS

<b>050 Gas Conversion Kit # 550002303</b>			
Conversion Kit #550002303 includes all items listed	DESCRIPTION	PART #	QTY
	Orifice, LP, 3.8mm	-	1
	Label, "Converted By"	-	2
	Label, "Nat to LP" conversion plate	-	1
	Label, "LP to Nat" conversion plate	-	1
	Instructions	240008957	1
<b>075 Gas Conversion Kit # 550002304</b>			
Conversion Kit #550002304 includes all items listed	DESCRIPTION	PART #	QTY
	Orifice, LP, 3.9mm	-	1
	Label, "Converted By"	-	2
	Label, "Nat to LP" conversion plate	-	1
	Label, "LP to Nat" conversion plate	-	1
	Instructions	240008957	1
<b>100 Gas Conversion Kit # 550002305</b>			
Conversion Kit #550002305 includes all items listed	DESCRIPTION	PART #	QTY
	Orifice, LP, 4.6mm	-	1
	Label, "Converted By"	-	2
	Label, "Nat to LP" conversion plate	-	1
	Label, "LP to Nat" conversion plate	-	1
	Instructions	240008957	1
<b>150 Gas Conversion Kit # 550002306</b>			
Conversion Kit #550002306 includes all items listed	DESCRIPTION	PART #	QTY
	Orifice, LP, 5.4mm	-	1
	Label, "Converted By"	-	2
	Label, "Nat to LP" conversion plate	-	1
	Label, "LP to Nat" conversion plate	-	1
	Instructions	240008957	1
<b>200 Gas Conversion Kit # 550002307</b>			
Conversion Kit #550002307 includes all items listed	DESCRIPTION	PART #	QTY
	Orifice, LP, 5.9mm	-	1
	Label, "Converted By"	-	2
	Label, "Nat to LP" conversion plate	-	1
	Label, "LP to Nat" conversion plate	-	1
	Instructions	240008957	1
<b>299 Gas Conversion Kit # 550002799</b>			
Conversion Kit #550002799 includes all items listed	DESCRIPTION	PART #	QTY
	Orifice, LP, 9.6mm	-	1
	Label, "Converted By"	-	2
	Label, "Nat to LP" conversion plate	-	1
	Label, "LP to Nat" conversion plate	-	1
	Instructions	240008957	1

## OPTIONAL ACCESSORIES

### High Altitude Kit

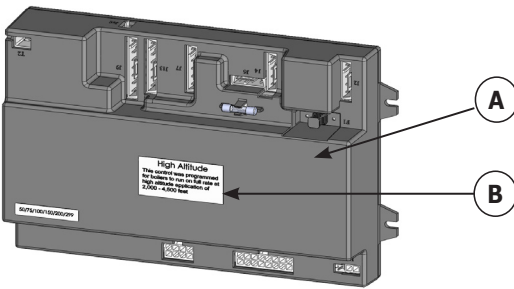

050/075/100/150/299 High Altitude Kit # 550002819				
	ITEM	DESCRIPTION	PART #	QTY
High Altitude Kit #550002819 includes all items listed	A	Control Module - High Altitude 2000 - 4500 ft.	-	1
	B	High Altitude label	-	1
	NOT SHOWN	Instructions, High Altitude	240010113	1

### Air Filter Kit

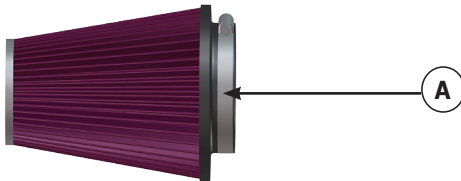

299 Air Filter Kit # 550003075				
	ITEM	DESCRIPTION	PART #	QTY
	A	Air Filter with Hose Clamp and Screw	-	1
	NOT SHOWN	Instructions, 299 Air Filter	240011093	1

### Floor Stand Kit

**WALL MOUNT BRACKET NOT INCLUDED WITH FLOOR STAND KIT**

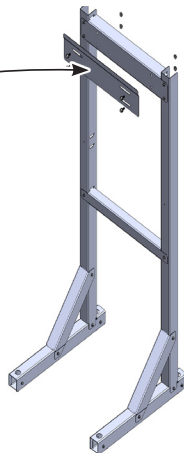

Floor Stand Kit # 240010266				
		DESCRIPTION	PART #	QTY
Floor Stand Kit #240010266 includes all items listed		Left Upright - not interchangeable	-	1
		Right Upright - not interchangeable	-	1
		Base Leg	-	2
		Brace	-	2
		Upper Cross Member	-	1
		Lower Cross Member	-	1
		Base Foot	-	4
		1/4 - 20 x 5/8 Serrated Hex Flange Head Bolt	-	26
		1/4 - 20 Serrated Hex Flange Head Nut	-	26
		5/16 - 18 x 3/4 Serrated Hex Head Bolt	-	4
		5/16 - 18 Serrated Flange Head Nut	-	4
		Instructions, Floor Stand	240010265	1

### Common Vent Flue Check Valve Kit

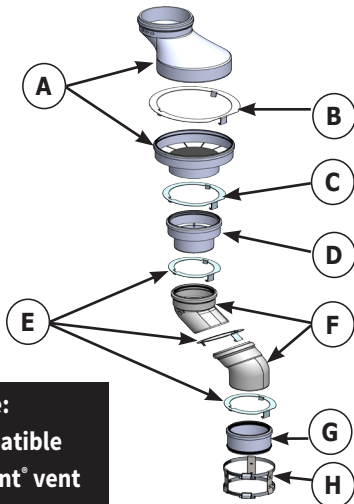

**\*Note:**  
Only compatible with DuraVent® vent pipe.

150/200/299 Common Vent Flue Check Valve Kit 240010299		
ITEM	DESCRIPTION	QTY
A	2 Piece Back Flow Valve	1
B	6" Locking Band	1
C	4" Locking Band	1
D	3" to 4" Increaser	1
E	3" Locking Band	3
F	3" 45° Elbow	2
G	3" Adapter for PVC Coupler	1
H	Adapter Connector	1
-	Instructions	1

## OPTIONAL ACCESSORIES



<b>Stainless Boiler Alarm Signal Output Kit #550002997</b>		
DESCRIPTION	PART #	Qty
Alarm Output Wire Harness	240010829	1
Alternate Alarm Output Wire Harness	240011269	1
Kit Instructions	240010830	1











<b>Concentric Vent Kits</b>	
DESCRIPTION	PART #
2" Concentric Vent Kit <sup>(1)</sup>	29570
3" Concentric Vent Kit <sup>(2)</sup>	29571
4" Concentric Vent Kit <sup>(3)</sup>	240011223
<sup>(1)</sup> <b>2" For use with 050/075/100</b>	
<sup>(2)</sup> <b>3" For use with 075-299</b>	
<sup>(3)</sup> <b>4" For use with 299</b>	

<b>Multi Boiler Sensor Kit # 550002186</b>			
Multi Boiler Sensor Kit #550002186 includes all items listed	DESCRIPTION	PART #	QTY
	Sensor, 12K, NTC, 6x45MM	240008465	1
	Well, 1/2 NPT Copper/Brass	240008466	1
	Sensor Well Lock Clip	240008467	1
	Instructions, Multi Boiler Sensor	240008959	1

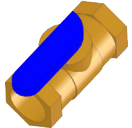
<b>Additional Heating Device Connection Kit (ie. Solar, Wood, etc.) Kit # 550002875</b>			
Kit # 550002875 includes all items listed	DESCRIPTION	PART #	QTY
	AR822 Control	Z140C	2
	System Sensor	240008465	1
	System Sensor Well	240008466	1
	Well Clip	240008467	1
	Kit Instructions	240010355	1





## MISC. REPLACEMENT PARTS



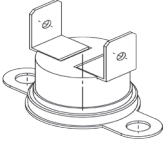

Replacement Parts		
	DESCRIPTION	PART #
	Igniter Cable 050/075/100/150/200	240008844
	Ignitor Cable 299	240009888
	Sight Glass	240008235
	Pump, Grundfos UP15-42F (050/075/100)	240008246
	Pump, Grundfos UP26-99 (150/200)	240008701
	* Pump, Grundfos UPS26-150 FC (299)	240010188
	*Pump, Taco 1/2 HP, (299)	240009836
	*Pump, B & G 1/2 HP, (299)	240009971
	Boiler Drain Valve	240009323
	LWCO, Hydrolevel Safeguard 1100 MINI, 24 VAC	240008250
	LWCO, Taco 1100 (299)	240009838
	High Temperature Supply Switch	240008290

Replacement Parts		
	DESCRIPTION	PART #
	Sensor, Return Water (050/075/100)	240008226
	Sensor, Return Water (150/200/299)	240008703
	Sensor, Flue	240008227
	Clamp, 1-1/8" Spring Tension for Condensate Trap	240008406
	Ball Valve 1/2" Female NPT x 5/8", FLR (Gas Shutoff valve) (050/075/100/150/200/299)	240008297
	Ball Valve 3/4" Female (Gas Shutoff valve) (299)	14657001
	***Safety Relief Valve (30 PSI) Conbraco 10-407-05	VR-001.01
	Air Vent, Watts FV-4M1, 1/4 NPT	240008458
	Wall Bracket Sizes 050/075/100	109008079
	Wall Bracket Sizes 150/200/299	109008347
	Cap Black Vinyl 3/16"	1230006
	Clamp, Spring Tension for Black Vinyl Cap	1110001



## MISC. REPLACEMENT PARTS - CONTI.

Replacement Parts		
	DESCRIPTION	PART #
	Temperature Switch L300-40F	240009508
	Sensor, Outdoor	240008225
	** Gauge, Temperature Pressure, 2" shank (0 ~ 75 psi)	1260006
	** Gauge, Temperature Pressure, 2" shank (0 ~ 200 psi)	GA00501
	Fuse, 3.15A AC, 250V, Slo- Blo Glass 5x20mm	240008665

Replacement Parts		
	DESCRIPTION	PART #
	Relay, 120 VAC, 10 A	240008410
	Latch, Wire Bale, 1-3/8" Gap	240008540
	Hook, Draw Latch	240008541
	Condensate Hose 3/4"OD x 3.75" 050/075/100 mbh	3002228
	Condensate Hose 3/4"OD x 5" 150/200 mbh	3002229

\* When ordering an optional pump other than factory supplied, 4 field sourced proper length bolts may be required.

\*\* For low pressure system , use 0~75 psi factory supplied pressure temperature gauge. For system pressure higher than 60 psi, use optional or field sourced 0~200 psi pressure temperature gauge.

\*\*\* For heating system with system pressure high than 25 psi, field source proper Safety relief valve.

## QUICK INDEX

KIT NAME	KIT NO.	APPLIED ON MODELS						INSTRUCTION NO.
		50	75	100	150	200	299	
<b>Additional Heating Device Connection Kit</b>	550002875	✓	✓	✓	✓	✓	✓	240010355
<b>Air Filter Kit</b>	550003075						✓	240011093
<b>Alarm Signal Output Kit</b>	550002997	✓	✓	✓	✓	✓	✓	240010830
<b>Blower Replacement Kit</b>	550002291	✓	✓	✓				240008943
	550002292				✓			
	550002293					✓		
	550002812						✓	240010105
<b>Blower High Altitude Replacement Kit</b>	550003058					✓		240008943
<b>Burner Replacement Kit</b>	550002276	✓						240008933
	550002277		✓					
	550002278			✓				
	550002279				✓	✓		
	550002809						✓	240010106
<b>Burner Inspection Kit</b>	550002280	✓	✓	✓	✓	✓		240008931
	550002818						✓	240010107
<b>Concentric Vent Kit</b>	29570 (2")	✓	✓	✓				N/A
	29571 (3")	✓	✓	✓	✓	✓	✓	
	240011223						✓	
<b>Condensate Collector Replacement Kit</b>	550002294	✓	✓	✓				240008946
	550002295				✓	✓		
<b>Condensate Trap Replacement Kit</b>	550002296	✓	✓	✓				240008948
	550002297				✓	✓		
	550002814						✓	
<b>Control Module Replacement Kit</b>	550002583	✓	✓	✓	✓	✓	✓	240009314
<b>Flame Sensor Replacement Kit</b>	550002283	✓	✓	✓				240008593
	550002284				✓	✓		
	550002810						✓	
<b>Flexible Gas Line Replacement Kit</b>	550002289	✓	✓	✓				240008941
	550002290				✓	✓		
	550002813						✓	
<b>Floor Stand Kit</b>	240010266	✓	✓	✓	✓	✓	✓	240010265

**QUICK INDEX - CONTI.**

KIT NAME	KIT NO.	APPLIED ON MODELS						INSTRUCTION NO.
		50	75	100	150	200	299	
<b>Gas Valve (Automatic)</b> Replacement Kit	550002329	✓						240008939
	550002285		✓					
	550002286			✓				
	550002287				✓			
	550002288					✓		
	550002811						✓	240010104
<b>Heat Exchanger Surface Temperature Switch</b> Kit	550002554	✓	✓	✓				240009568
	550002555				✓	✓		
	550002820						✓	
<b>Heat Exchanger</b> Replacement Kit	550002271	✓						240008928
	550002272		✓					
	550002273			✓				
	550002274				✓			
	550002275					✓		
	550002808						✓	240010108
<b>High Altitude</b> Kit	550002819	✓	✓	✓	✓		✓	240010113
<b>Igniter</b> Replacement Kit	550002190	✓	✓	✓				240008592
	550002282				✓	✓	✓	
<b>Jacket</b> Replacement Kit	550003135	✓	✓	✓				N/A
	550003138				✓	✓		
	550003141						✓	
<b>LP Gas Conversion</b> Kit	550002303	✓						240008957
	550002304		✓					
	550002305			✓				
	550002306				✓			
	550002307					✓		
	550002799						✓	
<b>Multi Boiler Sensor</b> Kit	550002186	✓	✓	✓	✓	✓	✓	240008959
<b>User Interface</b> Replacement Kit	550002299	✓	✓	✓	✓	✓	✓	240008930
<b>Wire Harness</b> Replacement Kit	550003200	✓	✓	✓				240011560
	550003201				✓	✓		
	550003202						✓	



2201 Dwyer Avenue, Utica, NY 13501

Tel. 800 253 7900

[www.ecrinternational.com](http://www.ecrinternational.com)

All specifications subject to change without notice.

©2018 ECR International, Inc.