



US Trade Price Book - 2021

Effective 5/17/21



Innovative. Efficient. Dependable. Dunkirk.



www.dunkirk.com



Manufactured by:
ECR International Inc.
2201 Dwyer Avenue, Utica, NY 13501
Tel. 800 325 5479
www.ecrinternational.com
PN 240005064 REV. o [05/15/2021]

CUSTOMER SUPPORT TEAM

CUSTOMER SERVICE:

Phone: (800) 325-5479 option #2
Fax: (315) 724-9319
Email Purchase Orders: ecrorderentry@ecrinternational.com
Email Inquiries: customerservice@ecrinternational.com

TECHNICAL SUPPORT:

Phone: (800) 253-7900
Fax: (866) 432-7329
Email: technical.support@ecrinternational.com

MARKETING SUPPORT:

Phone: (800) 325-5479
Fax: (315) 733-1759
E-mail: marketing@ecrinternational.com

WWW.ECRCUSTOMERPORTAL.COM

Your On-line Access to:

- Order Status
- Invoices
- Statements
- RMA
- Serial Number Look-Up
- Literature

Table of Contents

<u>Condensing Natural / LP Gas Boilers with [AI] Control (Gas Adaptive)</u>		4-7
DCC/DCB	Stainless Steel Wall Hung Combi & Heating Boilers (93.5-205 MBH)	4
DCCF/DCBF	Stainless Steel Floor Standing Combi & Heating Boilers (125-205 MBH)	6
<u>Condensing Natural / LP Gas Boilers</u>		8-15
Q90	Cast-Aluminum Floor Standing Heating Boilers (50-100 MBH)	8
HELIX VLT	Stainless Steel Wall Hung Heating Boilers (50-200 MBH)	10
DMG 240	Stainless Steel Wall Hung Heating Boilers (241 MBH)	12
DMG 380	Stainless Steel Floor Standing Heating Boilers (379 MBH)	14
<u>Controls & Venting</u>		16-19
MBC	Multiple Boiler Control (MBC)	16
WI-FIT-STAT	Argo Wi-Fi Thermostat	16
VENTING	Coaxial, Twin Pipe & CPVC Venting for Condensing Boilers	17
<u>Natural / LP Gas Boilers</u>		20-39
DWB	Copper Wall Hung Combi & Heating Boilers (100-150 MBH)	20
XEB	Cast Iron Induced Draft Chimney/Side Wall Vented (42.5-187.5 MBH)	22
DXL	Cast Iron Chimney Vented Boilers (59-235 MBH)	26
WPSB	Cast Iron Integral Draft Diverter Boilers (75-299 MBH)	30
PSB	Cast Iron Steam Boilers (75-299 MBH)	34
D249	Cast Iron Commercial Steam Boilers (300-1,500 MBH)	36
<u>Oil Boilers</u>		40-51
EXCELSIOR EXB	Cast Iron 3-Pass Boilers (105-231 MBH)	40
DHW MODULE	Domestic Hot Water Module	40
EMPIRE EWC	Cast Iron Chimney Vented Boilers (112-217 MBH)	44
SBO	Cast Iron Steam Boilers (119-210 MBH)	48
<u>Indirect Tanks</u>		50-59
H2O GL	Single Coil Glass Lined Indirect Water Heaters (31-106 GALS)	50
H2O SC	Single Coil Stainless Steel Indirect Water Heaters (30-115 GALS)	52
H2O DC	Single & Dual Coil Stainless Steel Solar Water Heaters (60-115 GALS)	54
H2O BT	Stainless Steel Buffer Tanks (With & Without Coil) (22-115 GALS)	56
H2O ST	Stainless Steel Storage Tanks (No Coil) (30-115 GALS)	58
<u>Terms, Shipping & Delivery Policy, RMA Policy</u>		60-62

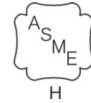

DCC/DCB Stainless Steel Wall Hung Combi & Heating Boilers

- MBH Input 93.5 - 164 (CH) / 115.5 - 205 (DHW)
- 95% AFUE
ENERGY STAR® Certified
- [AI] Control Technology Recognizes Natural or LP Gas
No field conversion kit required.
- 6.9:1 Turndown Modulation Ratio in DHW Mode (115)
7:1 Turndown Modulation Ratio in DHW Mode (150/205)
5.7:1 Turndown Modulation Ratio in CH Mode (125/150)
5.5:1 Turndown Modulation Ratio in CH Mode (165/205)
- 2.5 gpm DHW Flow Rate @ 70°F Rise (115)
3.5 gpm DHW Flow Rate @ 70°F Rise (150)
5 gpm DHW Flow Rate @ 70°F Rise (205)
- LABOR SAVER™ Primary/Secondary Manifold Included
- Low Water Pressure Switch
- Wall Hung or Floor Stand Kit Available



General Information (See IOM for Complete Instructions)					
Model	DCB-125	DCC-115	DCC-150	DCB-165	DCC-205
Water Return/Supply	3/4" SWT			1" SWT	
Gas	3/4" FPT			3/4" FPT	
Condensate Drain	13/16" ID Hose			3/4" NPT	
DHW Outlet (125 Optional)	1/2"			3/4"	
DHW (Cold Water) Inlet	1/2"			3/4"	
Electrical	120 Volts AC, 60 hertz, 1 phase, less than 12 amps (15 amp circuit recommended)				
Water Content (Gallons)	1			1 1/4	
Dimensions	A-Height	30"			30"
	B-Width	17 3/4"			17 3/4"
	C-Depth	13 9/16"			21 1/2"

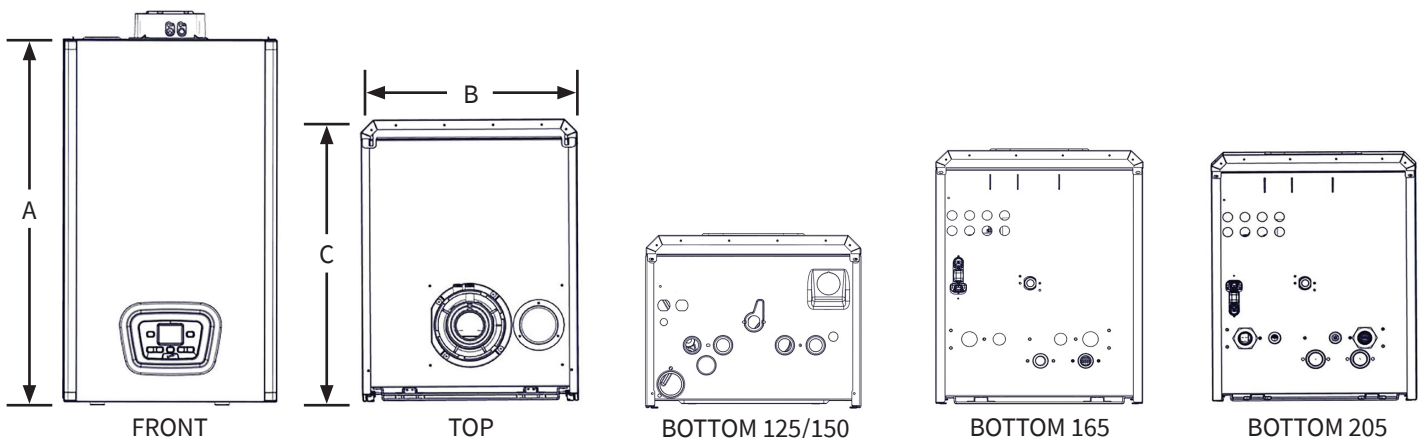

DCC/DCB - Stainless Steel Wall Hung Combi & Heating Boilers

Model	Item Number	Type	Input MBH CH	Input MBH DHW	AHRI Net MBH	AFUE	Fuel	Pump	Shp. Wgt. lbs	Trade Price
DCB125	DCB112503600103	HEATING	125	N/A	98	95.0%	NAT/LP	LESS	102	\$2,984
DCB165	DCB116503600103	HEATING	164	N/A	133	95.0%	NAT/LP	LESS	125	\$3,503
DCC115	DCC111503600103	COMBI	93.5	115.5	74	95.0%	NAT/LP	LESS	103	\$2,604
DCC150	DCC115003600103	COMBI	125	153	98	95.0%	NAT/LP	LESS	103	\$3,186
DCC205	DCC120503600103	COMBI	164	205	133	95.0%	NAT/LP	LESS	125	\$3,699
DCB125	DCB112503640103	HEATING	125	N/A	98	95.0%	NAT/LP	TACO ECM	102	\$3,134
DCB165	DCB116503640103	HEATING	164	N/A	133	95.0%	NAT/LP	TACO ECM	125	\$3,653
DCC115	DCC111503640103	COMBI	93.5	115.5	74	95.0%	NAT/LP	TACO ECM	103	\$2,758
DCC150	DCC115003640103	COMBI	125	153	98	95.0%	NAT/LP	TACO ECM	103	\$3,337
DCC205	DCC120503640103	COMBI	164	205	133	95.0%	NAT/LP	TACO ECM	125	\$3,848
DCB125	DCB112503620103	HEATING	125	N/A	98	95.0%	NAT/LP	GRUNDFOS	102	\$3,134
DCB165	DCB116503620103	HEATING	164	N/A	133	95.0%	NAT/LP	GRUNDFOS	125	\$3,653
DCC115	DCC111503620103	COMBI	93.5	115.5	74	95.0%	NAT/LP	GRUNDFOS	103	\$2,758
DCC150	DCC115003620103	COMBI	125	153	98	95.0%	NAT/LP	GRUNDFOS	103	\$3,337
DCC205	DCC120503620103	COMBI	164	205	133	95.0%	NAT/LP	GRUNDFOS	125	\$3,848

DCC/DCB (Use Parts Multiplier for All of the Following)

Model	Item Number	Description	Trade Price
DCC(B)	BD710487302V	OUTSIDE AIR SENSOR	\$38
DCC(B)	550003189	DHW SENSOR KIT	\$82
DCC(B)	240010266	FLOOR STAND KIT	\$680
DCC(B)	550003212	HEAT EXCHANGER CLEANING KIT	\$57

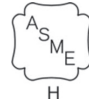

DCCF/DCBF Stainless Steel Floor Standing Combi & Heating Boilers

- MBH Input 125 - 164 (CH) / 153 - 205 (DHW)
- 95% AFUE
ENERGY STAR® Certified
- [AI] Control Technology Recognizes Natural or LP Gas
No field conversion kit required.
- 7:1 Turndown Modulation Ratio in DHW Mode
5.7:1 Turndown Modulation Ratio in CH Mode (125/150)
5.5:1 Turndown Modulation Ratio in CH Mode (165/205)
- 3.5 gpm DHW (150) @ 70°F Rise
5.0 gpm DHW (205) @ 70°F Rise
- LABOR SAVER™ Primary/Secondary Manifold Built-In
- Low Water Pressure Switch
- Compact, Floor Standing Design



General Information (See IOM for Complete Instructions)				
Model	DCBF-125	DCCF-150	DCBF-165	DCCF-205
Water Return/Supply	1 1/4" Copper	1 1/4" Copper	1 1/2" Copper	1 1/2" Copper
Gas	3/4" NPT	3/4" NPT	3/4" NPT	3/4" NPT
Condensate Drain	3/4" NPT	3/4" NPT	3/4" NPT	3/4" NPT
DHW Outlet (125 Optional)	3/4" SWT	1/2" SWT	NA	3/4" SWT
DHW (Cold Water) Inlet	NA	1/2" SWT	NA	3/4" SWT
Electrical	120 Volts AC, 60 hertz, 1 phase, less than 12 amps (15 amp circuit recommended)			
Water Content (Gallons)	1	1	1.25	1.25
Dimensions	A-Height	43.65"	43.65"	43.65"
	B-Width	24.7"	24.7"	24.7"
	C-Depth	17.46"	17.46"	23.55"

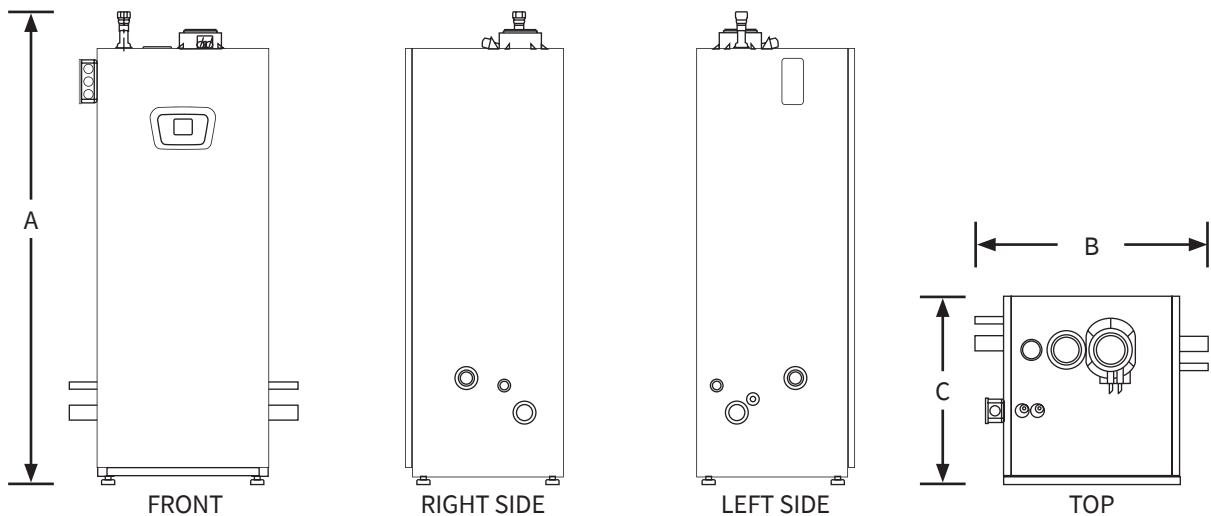

DCCF/DCBF - Stainless Steel Floor Standing Combi & Heating Boilers

Model	Item Number	Type	Input MBH CH	Input MBH DHW	AHRI Net MBH	AFUE	Fuel	Pump	Shp. Wgt. lbs	Trade Price
DCBF125	DCB112505600103	HEATING	125	N/A	98	95.0%	NAT/LP	LESS	106	\$3,327
DCBF165	DCB116505600103	HEATING	164	N/A	133	95.0%	NAT/LP	LESS	158	\$4,028
DCCF150	DCC115005600103	COMBI	125	153	98	95.0%	NAT/LP	LESS	106	\$3,552
DCCF205	DCC120505600103	COMBI	164	205	133	95.0%	NAT/LP	LESS	168	\$4,254
DCBF125	DCB112505640103	HEATING	125	N/A	98	95.0%	NAT/LP	TACO ECM	106	\$3,481
DCBF165	DCB116505640103	HEATING	164	N/A	133	95.0%	NAT/LP	TACO ECM	158	\$4,201
DCCF150	DCC115005640103	COMBI	125	153	98	95.0%	NAT/LP	TACO ECM	106	\$3,707
DCCF205	DCC120505640103	COMBI	164	205	133	95.0%	NAT/LP	TACO ECM	168	\$4,425
DCBF125	DCB112505620103	HEATING	125	N/A	98	95.0%	NAT/LP	GRUNDFOS	106	\$3,481
DCBF165	DCB116505620103	HEATING	164	N/A	133	95.0%	NAT/LP	GRUNDFOS	158	\$4,201
DCCF150	DCC115005620103	COMBI	125	153	98	95.0%	NAT/LP	GRUNDFOS	106	\$3,707
DCCF205	DCC120505620103	COMBI	164	205	133	95.0%	NAT/LP	GRUNDFOS	168	\$4,425

DCCF/DCBF (Use Parts Multiplier for All of the Following)

Model	Item Number	Description	Trade Price
DCC(B)F	BD710487302V	OUTSIDE AIR SENSOR	\$38
DCC(B)F	550003189	DHW SENSOR KIT	\$82
DCC(B)F	550003212	HEAT EXCHANGER CLEANING KIT	\$57

Q90 Cast-Aluminum Floor Standing Heating Boilers

- MBH Input 50 - 100 (CH)
- 90% AFUE
ENERGY STAR® Certified
- Natural or LP Gas
- High Efficiency Cast Aluminum Heat Exchanger
- Fuel Smart Hydrostat Control: Temperature Limit
- Low Water Cut Off (LWCO)
- Boiler Reset
- Compact Design, Floor Standing Design
- Stainless Steel Premix Burner
- Sealed Combustion
- Induced Draft Blower with Adjustable Exhaust



General Information (See IOM for Complete Instructions)			
Model	Q90-50	Q90-75	Q90-100
Water Return/Supply	1 1/4" NPT		
Gas	1/2" NPT		
Condensate Drain	1/2" CPVC Stub		
Electrical	120 Volts AC, 60 hertz, 1 phase, less than 12 amps (15 amp circuit recommended)		
Water Content (Gallons)	2.6		
Dimensions	A-Height	36 1/4"	
	B-Width	17 3/4"	
	C-Depth	17 3/8"	

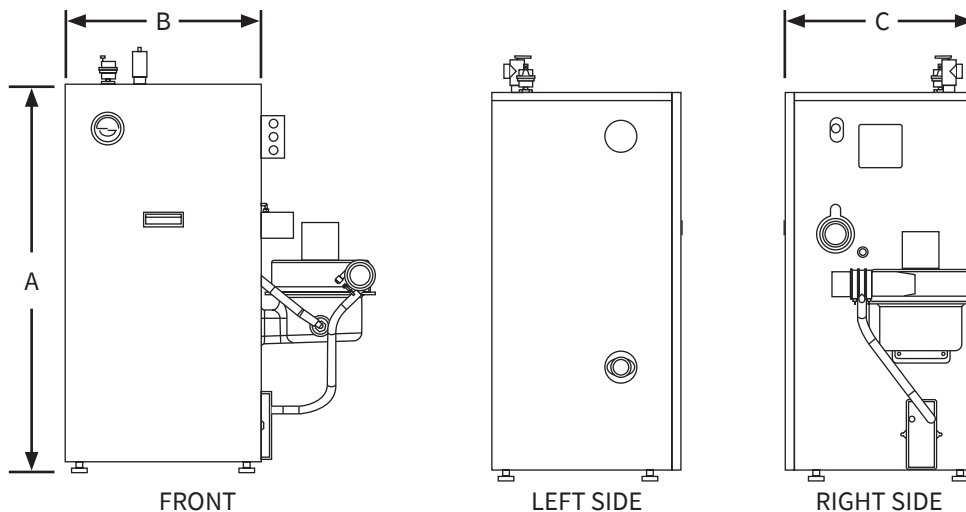

Q90 - Cast-Aluminum Floor Standing Heating Boilers

Model	Item Number	Input MBH	AHRI Net MBH	AFUE	Fuel	Pump	Shp. Wgt. lbs	Trade Price
Q90-50	Q90205003200403	50	39	90.0%	NAT	LESS	256	\$3,509
Q90-75	Q90207503200403	75	59	90.0%	NAT	LESS	256	\$3,509
Q90-100	Q90210003200403	100	78	90.0%	NAT	LESS	256	\$3,509
Q90-50	Q90205003240403	50	39	90.0%	NAT	TACO ECM	256	\$3,581
Q90-75	Q90207503240403	75	59	90.0%	NAT	TACO ECM	256	\$3,581
Q90-100	Q90210003240403	100	78	90.0%	NAT	TACO ECM	256	\$3,581
Q90-50	Q90205003220403	50	39	90.0%	NAT	GRUNDFOS	256	\$3,581
Q90-75	Q90207503220403	75	59	90.0%	NAT	GRUNDFOS	256	\$3,581
Q90-100	Q90210003220403	100	78	90.0%	NAT	GRUNDFOS	256	\$3,581

Q90 - LP

Q90-50	Q90205013200403	50	39	90.0%	LP	LESS	256	\$3,509
Q90-75	Q90207513200403	75	59	90.0%	LP	LESS	256	\$3,509
Q90-100	Q90210013200403	100	78	90.0%	LP	LESS	256	\$3,509
Q90-50	Q90205013240403	50	39	90.0%	LP	TACO ECM	256	\$3,581
Q90-75	Q90207513240403	75	59	90.0%	LP	TACO ECM	256	\$3,581
Q90-100	Q90210013240403	100	78	90.0%	LP	TACO ECM	256	\$3,581
Q90-50	Q90205013220403	50	39	90.0%	LP	GRUNDFOS	256	\$3,581
Q90-75	Q90207513220403	75	59	90.0%	LP	GRUNDFOS	256	\$3,581
Q90-100	Q90210013220403	100	78	90.0%	LP	GRUNDFOS	256	\$3,581

Q90 (Use Parts Multiplier for All of the Following)

Model	Item Number	Description	Trade Price
Q90	29571	CONCENTRIC VENT KIT 3"	\$252
Q90	29570	CONCENTRIC VENT KIT 2"	\$252
Q90-50	550002631	CONVERSION KIT NAT. TO LP UB90-50 (Series IV) 0' - 10,000'	\$87
Q90-75	550002629	CONVERSION KIT NAT. TO LP UB90-75 (Series IV) 5,000' - 10,000'	\$87
Q90-75	550002630	CONVERSION KIT NAT. TO LP UB90-75 (Series IV) 0' - 5,000'	\$87
Q90-100	550002700	CONVERSION KIT NAT. TO LP UB90-100 (Series IV) 0' - 10,000'	\$87
Q90-50	550002635	CONVERSION KIT LP TO NAT. UB90-50 (Series IV) 0' - 10,000'	\$87
Q90-75	550002634	CONVERSION KIT LP TO NAT. UB90-75 (Series IV) 0' - 10,000'	\$87
Q90-100	550002701	CONVERSION KIT LP TO NAT. UB90-100 (Series IV) 0' - 10,000'	\$87
Q90	14624002	FILL-TROL #110 FOR WATER BOILERS 150 MBH OR LESS	\$337

HELIX VLT Stainless Steel Wall Hung Heating Boilers

- MBH Input 50 - 200 (CH)
- 95% AFUE
ENERGY STAR® Certified
- Patented High-grade 316L/444 Stainless Steel Fin Coil Heat Exchanger
Patent No. 10,012,413
- Argus Vision Control
- Built-In Primary/Secondary Piping
- Built-In Low Water Cut Off
- 5:1 Turndown Ratio
- Low Maintenance, Self-Cleaning Vertical Heat Exchanger
- Wall mounted, Bracket Included



General Information (See IOM for Complete Instructions)					
Model	VLT-050	VLT-075	VLT-100	VLT-150	VLT-200
Water Return/Supply	1 1/4" NPT			1 1/4" NPT	
Gas	1/2" NPT			3/4" NPT	
Condensate Drain	3/4" NPT			3/4" NPT	
Electrical	120 Volts AC, 60 hertz, 1 phase, less than 12 amps (15 amp circuit recommended)				
Water Content (Gallons)	1.1			1.8	
Dimensions	A-Height	32"			43"
	B-Width	20"			23"
	C-Depth	14 3/4"			16"

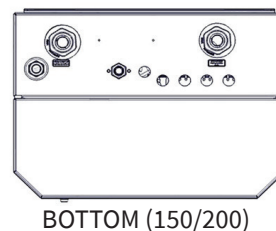
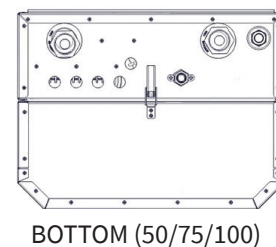
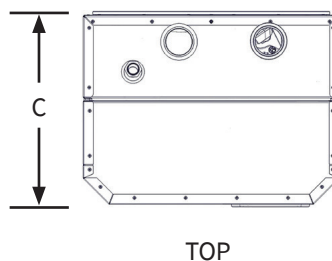
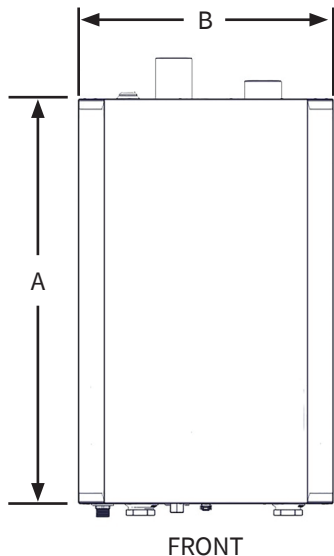

HELIX VLT - Stainless Steel Wall Hung Heating Boilers								
Model	Item Number	Input MBH	AHRI Net MBH	AFUE	Fuel	Pump	Shp. Wgt. lbs	Trade Price
DKVLT-50	VLT105003500203	50	40	95.0%	NAT	LESS	111	\$4,262
DKVLT-75	VLT107503500203	75	60	95.0%	NAT	LESS	111	\$4,345
DKVLT-100	VLT110003500203	100	79	95.0%	NAT	LESS	111	\$4,547
DKVLT-150	VLT115003500203	150	121	95.0%	NAT	LESS	182	\$5,738
DKVLT-200	VLT120003500203	200	161	95.0%	NAT	LESS	182	\$6,128
DKVLT-50	VLT105003540203	50	40	95.0%	NAT	TACO ECM	111	\$4,411
DKVLT-75	VLT107503540203	75	60	95.0%	NAT	TACO ECM	111	\$4,494
DKVLT-100	VLT110003540203	100	79	95.0%	NAT	TACO ECM	111	\$4,695
DKVLT-150	VLT115003540203	150	121	95.0%	NAT	TACO ECM	182	\$5,887
DKVLT-200	VLT120003540203	200	161	95.0%	NAT	TACO ECM	182	\$6,277
DKVLT-50	VLT105003520203	50	40	95.0%	NAT	GRUNDFOS	111	\$4,411
DKVLT-75	VLT107503520203	75	60	95.0%	NAT	GRUNDFOS	111	\$4,494
DKVLT-100	VLT110003520203	100	79	95.0%	NAT	GRUNDFOS	111	\$4,695
DKVLT-150	VLT115003520203	150	121	95.0%	NAT	GRUNDFOS	182	\$5,887
DKVLT-200	VLT120003520203	200	161	95.0%	NAT	GRUNDFOS	182	\$6,277
HELIX VLT - High Altitude*								
DKVLT-50	VLT105003502203	50*	40*	95.0%	NAT	LESS	111	\$4,262
DKVLT-75	VLT107503502203	75*	60*	95.0%	NAT	LESS	111	\$4,345
DKVLT-100	VLT110003502203	100*	79*	95.0%	NAT	LESS	111	\$4,547
DKVLT-150	VLT115003502203	150*	121*	95.0%	NAT	LESS	182	\$5,738
DKVLT-200	VLT120003502203	200*	161*	95.0%	NAT	LESS	182	\$6,128
DKVLT-50	VLT105003542203	50*	40*	95.0%	NAT	TACO ECM	111	\$4,411
DKVLT-75	VLT107503542203	75*	60*	95.0%	NAT	TACO ECM	111	\$4,494
DKVLT-100	VLT110003542203	100*	79*	95.0%	NAT	TACO ECM	111	\$4,695
DKVLT-150	VLT115003542203	150*	121*	95.0%	NAT	TACO ECM	182	\$5,887
DKVLT-200	VLT120003542203	200*	161*	95.0%	NAT	TACO ECM	182	\$6,277
DKVLT-50	VLT105003522203	50*	40*	95.0%	NAT	GRUNDFOS	111	\$4,411
DKVLT-75	VLT107503522203	75*	60*	95.0%	NAT	GRUNDFOS	111	\$4,494
DKVLT-100	VLT110003522203	100*	79*	95.0%	NAT	GRUNDFOS	111	\$4,695
DKVLT-150	VLT115003522203	150*	121*	95.0%	NAT	GRUNDFOS	182	\$5,887
DKVLT-200	VLT120003522203	200*	161*	95.0%	NAT	GRUNDFOS	182	\$6,277
* High Altitude - Capacity Reduces with Elevation. Refer to IOM for Actual Capacity Ratings.								
HELIX VLT (Use Parts Multiplier for All of the Following)								
Model	Item Number	Description						Trade Price
DKVLT-50	550002303	050 NATURAL TO LP AND LP TO NATURAL GAS CONVERSION KIT						\$53
DKVLT-75	550002304	075 NATURAL TO LP AND LP TO NATURAL GAS CONVERSION KIT						\$53
DKVLT-100	550002305	100 NATURAL TO LP AND LP TO NATURAL GAS CONVERSION KIT						\$53
DKVLT-150	550002306	150 NATURAL TO LP AND LP TO NATURAL GAS CONVERSION KIT						\$53
DKVLT-200	550002307	200 NATURAL TO LP AND LP TO NATURAL GAS CONVERSION KIT						\$53
VLT SERIES	29570	2" CONCENTRIC VENT KIT						\$252
VLT SERIES	29571	3" CONCENTRIC VENT KIT						\$252
VLT SERIES	550002186	MULTIPLE BOILER SENSOR KIT						\$90
VLT SERIES	240010266	FLOOR STAND KIT						\$680
VLT SERIES	550003748	CSD-1 KIT						\$463

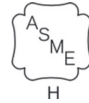

DMG-240 Stainless Steel Wall Hung Heating Boilers

- MBH Input 241 (CH)
- 95% AFUE
ENERGY STAR® Certified
- LABOR SAVER™ Manifold Included
- 6.7:1 Modulation Turndown Ratio
- Wall Hung or Floor Base Kit Available
- Anti-Wind Function: Control automatically adjusts the fan speed to prevent loss of flame and lockouts
- Flame Stabilization: Control allows the flame to stabilize before modulating, preventing flame drop outs and recycling
- Optional Plug-and-Play, CSD-1 Kit Available



General Information (See IOM for Complete Instructions)		
Model	DMG-240	
Water Return/Supply	1"	
Gas	3/4" NPT	
Condensate Drain	3/4" NPT	
Electrical	120 Volts AC, 60 hertz, 1 phase, less than 12 amps (15 amp circuit recommended)	
Water Content (Gallons)	.8	
Dimensions	A-Height	31 1/16"
	B-Width	17 3/4"
	C-Depth	23"

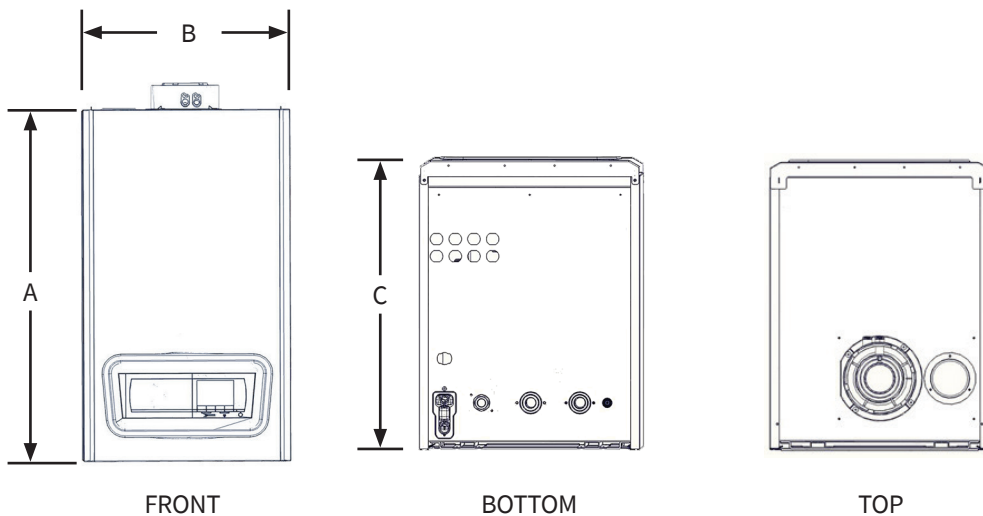

DMG 240 - Stainless Steel Wall Hung Heating Boilers

Model	Item Number	Input MBH	AHRI Net MBH	AFUE	Fuel	Pump	Shp. Wgt. lbs	Trade Price
DMG-240	DMG124000600103	241	216	95.0%	NAT	LESS	120	\$6,184

DMG 240 (Use Parts Multiplier for All of the Following)

Model	Item Number	Description	Trade Price
DMG-240	550003322	MANUAL RESET HIGH LIMIT KIT L4006E1109	\$267
DMG-240	550003323	MANUAL RESET LWCO KIT	\$256
DMG-240	550003332	CSD-1 KIT (INCLUDES HIGH LIMIT AND MANUAL RESET LWCO)	\$523
DMG-240	550003354	COMMON VENTING CHECK VALVE KIT	\$375
DMG-240	550003316	LP CONVERSION KIT	\$171
DMG-240	BD710487302V	OUTDOOR AIR SENSOR	\$38
DMG-240	550003189	DHW SENSOR KIT	\$82
DMG-240	550003304	FLOOR BASE KIT	\$528

DMG-380 Stainless Steel Floor Standing Heating Boilers

- MBH Input 379
- 95% Thermal Efficiency
- LABOR SAVER™ Manifold Included
- 10.5:1 Modulation Turndown Ratio
- Compact, Floor Standing Design
- Anti-Wind Function: Control automatically adjusts the fan speed to prevent loss of flame and lockouts
- Flame Stabilization: Control allows the flame to stabilize before modulating, preventing flame drop outs and recycling
- Optional Plug-and-Play, CSD-1 Kit Available



General Information (See IOM for Complete Instructions)		
Model	DMG-380	
Water Return/Supply	1 1/2"	
Gas	1" NPT	
Condensate Drain	3/4" NPT	
Electrical	120 Volts AC, 60 hertz, 1 phase, less than 12 amps (15 amp circuit recommended)	
Water Content (Gallons)	4.6	
Dimensions	A-Height	50"
	B-Width	23 5/8"
	C-Depth	25 1/2"

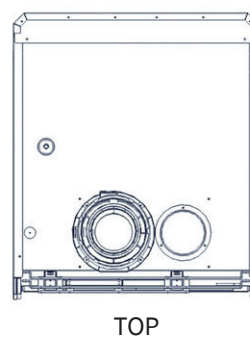
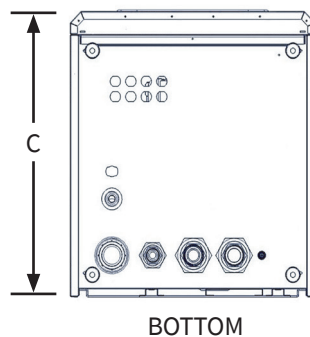
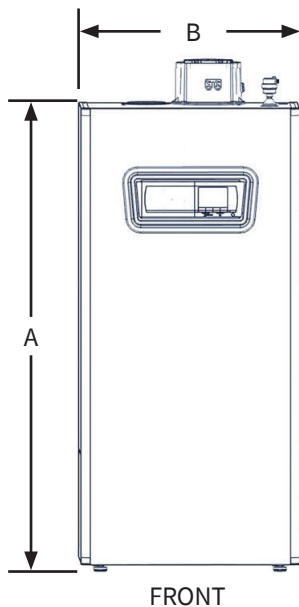

DMG 380 - Stainless Steel Floor Standing Heating Boilers

Model	Item Number	Input MBH	AHRI Net MBH	AFUE	Fuel	Pump	Shp. Wgt. lbs	Trade Price
DMG-380	DMG138000600103	379	303	95.0%	NAT	LESS	225	\$9,727

DMG 380 (Use Parts Multiplier for All of the Following)

Model	Item Number	Description	Trade Price
DMG-380	550003322	MANUAL RESET HIGH LIMIT KIT L4006E1109	\$267
DMG-380	550003323	MANUAL RESET LWCO KIT	\$256
DMG-380	550003332	CSD-1 KIT (INCLUDES HIGH LIMIT AND MANUAL RESET LWCO)	\$523
DMG-380	550003354	COMMON VENTING CHECK VALVE KIT	\$375
DMG-380	550003317	LP CONVERSION KIT	\$171
DMG-380	BD710487302V	OUTDOOR AIR SENSOR	\$38
DMG-380	550003189	DHW SENSOR KIT	\$82



MBC Multiple Boiler Control

- Operation of up to Four Boilers
- LCD Display
- Push Buttons for Navigating Settings
- Warm Weather Shutdown (WWSD)
- Set Back Scheduling
- Boiler Stage Delay
- Boiler Rotation
- Combustion or Alarm Control Relay
- Flow or Combustion Air Proof Delay
- Energy Management System Compatible (0-10 or 2-10 Vdc)
- Sensors Included:
 - (1) Outdoor Sensor
 - (2) Water Temperature Sensors



MBC - Staging Control			
Model	Item Number	Description	Trade Price
AMB4B	AMB4BDK	MULTIPLE BOILER CONTROL (MBC) ON/OFF CONTROL	\$1,243
Additional Accessories			
AMB4B	240012663	WATER TEMPERATURE SENSOR	\$100
AMB4B	240012664	OUTDOOR SENSOR	\$100



















ARGO Wi-Fi Thermostat

- Remote access and monitoring
- Improved serviceability. Having your installer connected provides better service
- Enjoy comfort, energy savings and lower utility bills
- Connect to compatible Dunkirk Boilers for additional benefits and monitoring capabilities
- Connect to multiple smartphones or tablets
- Control multiple thermostats from a single smartphone or tablet
- Switch between manual and schedule modes
- Ability to lock thermostat settings
- Display Setting can be set to Fahrenheit (°F) or Celsius (°C)



Wi-Fi Thermostats			
Model	Item Number	Description	Trade Price
ARGO	550003641DK	ARGO WI-FI THERMOSTAT	\$338





VENTING

Coaxial Venting (Use Parts Multiplier for All of the Following)							Image	Item Number	Description	Trade Price
125/150	165/205	Q90	VLT/VX	DMG 240	DMG 380					
X							KUG714059511	2"x4" (60/100mm)COAXIAL PIPE 3.28' (1m) L	\$41	
X							KUG714059611	2"x4" (60/100mm)HORIZONTAL VENT TERM	\$50	
X							KUG714059711	2"x4" (60/100mm)COAXIAL 90 ELBOWS	\$31	
X							KUG714059811	2"x4" (60/100mm)COAXIAL 45 ELBOWS	\$31	
X							KUG714135813	2"x4" (60/100mm)VERTICAL VENT TERM	\$121	
	X			X			KHG714088512	3"x5" (80/125mm)COAXIAL PIPE 3.28' (1m) L	\$60	
	X			X			KHG714088713	3"x5" (80/125mm)COAXIAL 90 ELBOWS	\$32	
	X			X			KHG714088812	3"x5" (80/125mm)COAXIAL 45 ELBOWS	\$32	
	X			X			KHG714088911	3"x5" (80/125mm)HORIZONTAL VENT TERM	\$68	
	X			X			KHG714093512	3"x5" (80/125mm)VERTICAL VENT TERM	\$94	
		X	X				29570	2" CONCENTRIC VENT KIT	\$252	
		X	X				29571	3" CONCENTRIC VENT KIT	\$252	
					X		KUG714133311	4"x6" (110/160mm)HORIZONTAL VENT TERM	\$249	
					X		KUG714133411	4"x6" (110/160mm)VERTICAL VENT TERM	\$316	
					X		KUG714133511	4"x6" (110/160mm)COAXIAL 45 ELBOWS	\$88	
					X		KUG714133611	4"x6" (110/160mm)COAXIAL 90 ELBOWS	\$88	
					X		KUG714133811	4"x6" (110/160mm)COAXIAL PIPE 3.28' (1m) L	\$122	

VENTING

Twin Pipe Polypropylene Venting (Use Parts Multiplier for All of the Following)							Image	Item Number	Description	Trade Price
125/150	165/205	Q90	VLT/VX	DMG 240	DMG 380					
X							KHG714059113	TO CONVERT FROM CONCENTRIC TO 3" TWIN PIPE	\$18	
X	X			X			550003416	3" (80mm)VENTING CLAMP SINGLE WALL	\$38	
X	X			X			550003452	3" (80mm)CLAMSHELL CLAMP (5PK)	\$37	
X	X			X			KUG714132010	3" (80mm)HORIZONTAL VENT TERM	\$21	
X	X			X			KUG714132110	3" (80mm)VERTICAL VENT TERM	\$49	
X	X			X			550003734	3" (80mm)POLYPROPYLENE 45 ELBOWS W/ CLAMP	\$15	
X	X			X			550003735	3" (80mm)POLYPROPYLENE 90 ELBOWS W/ CLAMP	\$15	
X	X			X			550003767	3" (80mm)POLYPROPYLENE PIPE 3.28' (1m) L W/ CLAMP	\$23	
	X			X			KHG714089010	TO CONVERT FROM CONCENTRIC TO 3" TWIN PIPE	\$41	
				X			550003453	4" (110mm)CLAMSHELL CLAMP (5PK)	\$49	
				X			BD7106314V	TO CONVERT FROM CONCENTRIC TO 4" TWIN PIPE	\$132	
				X			KUG714132710	4" (110mm)HORIZONTAL VENT TERM	\$127	
				X			KUG714132810	4" (110mm)VERTICAL VENT TERM	\$115	
				X			550003731	4" (110mm)POLYPROPYLENE 45 ELBOWS W/ CLAMP	\$33	
				X			550003732	4" (110mm)POLYPROPYLENE 90 ELBOWS W/ CLAMP	\$33	
				X			550003733	4" (110mm)POLYPROPYLENE PIPE 3.28' (1m) L W/ CLAMP	\$46	

VENTING

Twin Pipe CPVC Venting (Use Parts Multiplier for All of the Following)							Image	Item Number	Description	Trade Price
125/150	165/205	Q90	VLT/VX	DMG 240	DMG 380					
X							550003184	TWIN PIPE ADAPTER 60MM TO CPVC 3"	\$60	
	X		X				550003403	TWIN PIPE ADAPTER 80MM TO CPVC 3"	\$111	
		X					240009663	2" CPVC 90° ELBOW	\$30	
		X					240006819	2" CPVC TEE, SCHEDULE 80	\$41	
		X					240006822	2" CPVC COUPLING	\$27	

DWB Copper Wall Hung Combi & Heating Boilers

- MBH Input 50 - 150 (CH) / 150 (DHW)
- 85% AFUE
- LABOR SAVER™ Primary/Secondary Manifold Included
- Wall Hung or Floor Base Kit Available
- Chimney or Horizontal Vent
- Advanced Controls - Digital Display with temperature indication, diagnostics and status symbols showing: Heating mode, Burner On and Burner Modulation Level
- Combi Model: Stainless Steel Brazed Plate Heat Exchanger for potable domestic hot water



Shown with optional floor base kit

General Information (See IOM for Complete Instructions)				
Model	CCB-150	CHB-150	CHB-130	CHB-100
Water Return/Supply	3/4"	3/4"	3/4"	3/4"
Gas	3/4" NPT	3/4" NPT	3/4" NPT	3/4" NPT
Condensate Drain	3/4" NPT	3/4" NPT	3/4" NPT	3/4" NPT
DHW Outlet	3/4" NPT	Indirect Tank Connection: 3/4" Capped		
DHW Inlet	3/4" NPT	Indirect Tank Connection: 3/4" Capped		
Electrical	120 Volts AC, 60 hertz, 1 phase, less than 12 amps (15 amp circuit recommended)			
Water Content (Gallons)	.396	.396	.317	.211
Dimensions	A-Height	27 9/16"	27 9/16"	27 9/16"
	B-Width	17 23/32"	17 23/32"	15 3/4"
	C-Depth	13"	13"	13"

DWB Combi Unit (CCB-150) Shown

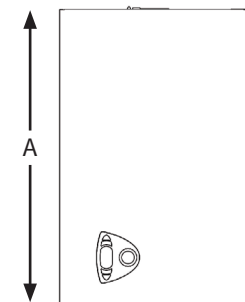

FRONT

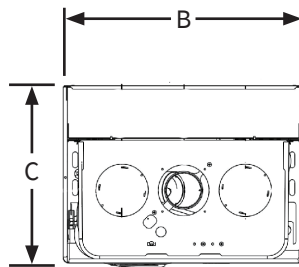

TOP

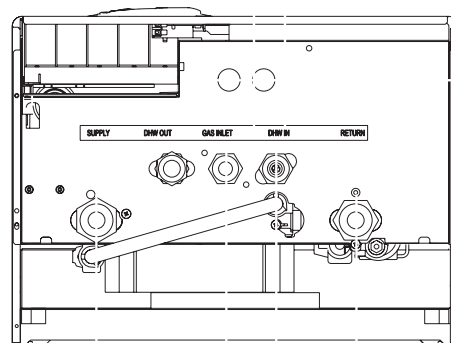

BOTTOM

DWB - Copper Wall Hung Combi or Heating Boilers									
Model	Item Number	Type	Input MBH	AHRI Net MBH	AFUE	Fuel	Pump	Shp. Wgt. lbs	Trade Price
CCB150	CCB0150000103	COMBI	150	110	85.0%	NAT	LESS	78	\$2,435
CHB100	CHB0100000103	HEATING	100	73	85.0%	NAT	LESS	65	\$1,884
CHB130	CHB0130000103	HEATING	130	96	85.0%	NAT	LESS	69	\$2,090
CHB150	CHB0150000103	HEATING	150	110	85.0%	NAT	LESS	73	\$2,210
DWB (Use Parts Multiplier for All of the Following)									
Model	Item Number	Description							Trade Price
CCB/CHB150	FE3980C150	NATURAL TO LP CONVERSION KIT (CCB150 & CHB-150)							\$78
CHB100	FE3980C300	NATURAL TO LP CONVERSION KIT (CHB100)							\$69
CHB130	FE3980B950	NATURAL TO LP CONVERSION KIT (CHB130)							\$71
DWB SERIES	5612601	DIRECT VENT KIT							\$164
DWB SERIES	FE013018X0	OUTSIDE AIR SENSOR							\$35
DWB SERIES	550002958	DHW SENSOR KIT							\$63
DWB SERIES	240010266	FLOOR STAND KIT							\$680
CHB100/130	550003450	CHB 100/130 FLOOR BASE KIT							\$375
CCB/CHB150	550003451	CCB/CHB 150 FLOOR BASE KIT							\$375

XEB Cast Iron Induced Draft Chimney/Side Wall Vented Boilers

- MBH Input 42.5 - 187.5 (CH)
- Up to 84.4% AFUE
- Dependable Cast Iron Heat Exchanger with Cast Iron Push Nipples
- Honeywell High Limit/Electronic Ignition Control
 - Recessed under the boiler's protective jacket
 - Digital Temperature display and diagnostics
 - Plug in connection for the inducer fan
 - Plug in connection for the system pump
- Induced Draft Fan



General Information (See IOM for Complete Instructions)						
Model	XEB-2	XEB-3	XEB-4	XEB-5	XEB-6	
Water Return/Supply	1 1/4" NPT					
Gas	1/2" NPT					
Electrical	120 Volts AC, 60 hertz, 1 phase, less than 12 amps (15 amp circuit recommended)					
Water Content (Gallons)	1.75	3.00	4.25	5.50	6.75	
Dimensions	A-Height	29"	29"	29"	29"	
	B-Width	11"	14 1/4"	17 1/2"	20 3/4"	24"
	C-Depth	23 1/4"	23 1/4"	23 1/4"	23 1/4"	23 1/4"

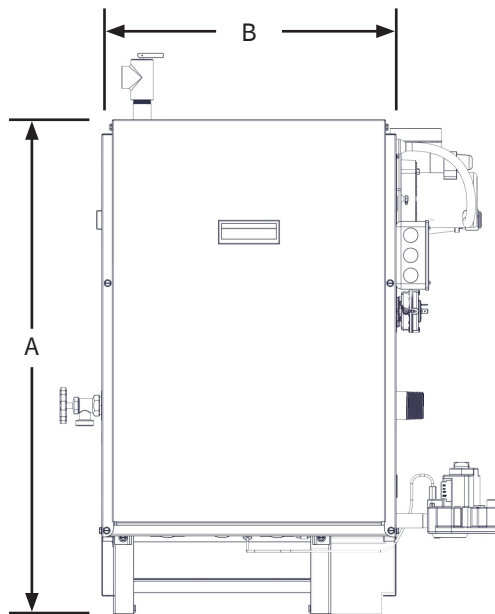

FRONT

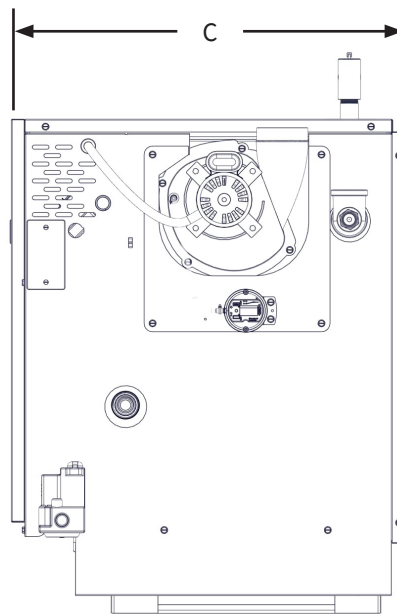

RIGHT SIDE

XEB - Cast Iron Induced Draft Chimney/Side Wall Vented Boilers									
Model	Item Number	Input MBH	Htg. Cap. MBH	AHRI Net MBH	AFUE	Fuel	Pump	Shp. Wgt. Lbs	Trade Price
XEB-2	XEB204203100303	42.5	36	31	84.4%	NAT	LESS	225	\$2,360
XEB-3	XEB307503100303	75	63	55	84.0%	NAT	LESS	265	\$2,671
XEB-4	XEB411203100303	112.5	95	82	84.0%	NAT	LESS	322	\$2,952
XEB-5	XEB515003100303	150	127	109	84.0%	NAT	LESS	370	\$3,317
XEB-6	XEB618703100303	187.5	158	135	84.0%	NAT	LESS	431	\$3,894
XEB-2	XEB204203140303	42.5	36	31	84.4%	NAT	TACO ECM	225	\$2,444
XEB-3	XEB307503140303	75	63	55	84.0%	NAT	TACO ECM	265	\$2,753
XEB-4	XEB411203140303	112.5	95	82	84.0%	NAT	TACO ECM	322	\$3,035
XEB-5	XEB515003140303	150	127	109	84.0%	NAT	TACO ECM	370	\$3,398
XEB-6	XEB618703140303	187.5	158	135	84.0%	NAT	TACO ECM	431	\$3,982
XEB-2	XEB204203120303	42.5	36	31	84.4%	NAT	GRUNDFOS	225	\$2,444
XEB-3	XEB307503120303	75	63	55	84.0%	NAT	GRUNDFOS	265	\$2,753
XEB-4	XEB411203120303	112.5	95	82	84.0%	NAT	GRUNDFOS	322	\$3,035
XEB-5	XEB515003120303	150	127	109	84.0%	NAT	GRUNDFOS	370	\$3,398
XEB-6	XEB618703120303	187.5	158	135	84.0%	NAT	GRUNDFOS	431	\$3,982
XEB-2	XEB204203130303	42.5	36	31	84.4%	NAT	B&G	225	\$2,444
XEB-3	XEB307503130303	75	63	55	84.0%	NAT	B&G	265	\$2,753
XEB-4	XEB411203130303	112.5	95	82	84.0%	NAT	B&G	322	\$3,035
XEB-5	XEB515003130303	150	127	109	84.0%	NAT	B&G	370	\$3,398
XEB-6	XEB618703130303	187.5	158	135	84.0%	NAT	B&G	431	\$3,982

XEB - LP									
XEB-2	XEB204213100303	42.5	36	31	84.4%	LP	LESS	225	\$2,416
XEB-3	XEB307513100303	75	63	55	84.0%	LP	LESS	265	\$2,729
XEB-4	XEB411213100303	112.5	95	82	84.0%	LP	LESS	322	\$3,008
XEB-5	XEB515013100303	150	127	109	84.0%	LP	LESS	370	\$3,373
XEB-6	XEB618713100303	187.5	158	135	84.0%	LP	LESS	431	\$3,951
XEB-2	XEB204213140303	42.5	36	31	84.4%	LP	TACO ECM	225	\$2,499
XEB-3	XEB307513140303	75	63	55	84.0%	LP	TACO ECM	265	\$2,809
XEB-4	XEB411213140303	112.5	95	82	84.0%	LP	TACO ECM	322	\$3,091
XEB-5	XEB515013140303	150	127	109	84.0%	LP	TACO ECM	370	\$3,455
XEB-6	XEB618713140303	187.5	158	135	84.0%	LP	TACO ECM	431	\$4,038
XEB-2	XEB204213120303	42.5	36	31	84.4%	LP	GRUNDFOS	225	\$2,499
XEB-3	XEB307513120303	75	63	55	84.0%	LP	GRUNDFOS	265	\$2,809
XEB-4	XEB411213120303	112.5	95	82	84.0%	LP	GRUNDFOS	322	\$3,091
XEB-5	XEB515013120303	150	127	109	84.0%	LP	GRUNDFOS	370	\$3,455
XEB-6	XEB618713120303	187.5	158	135	84.0%	LP	GRUNDFOS	431	\$4,038

XEB - Cast Iron Induced Draft Chimney/Side Wall Vented Boilers (Cont.)

Model	Item Number	Input MBH	Htg. Cap. MBH	AHRI Net MBH	AFUE	Fuel	Pump	Shp. Wgt. Lbs	Trade Price
XEB-2	XEB204213130303	42.5	36	31	84.4%	LP	B&G	225	\$2,499
XEB-3	XEB307513130303	75	63	55	84.0%	LP	B&G	265	\$2,809
XEB-4	XEB411213130303	112.5	95	82	84.0%	LP	B&G	322	\$3,091
XEB-5	XEB515013130303	150	127	109	84.0%	LP	B&G	370	\$3,455
XEB-6	XEB618713130303	187.5	158	135	84.0%	LP	B&G	431	\$4,038

XEB - High Altitude*

XEB-2	XEB204203145303	42.5*	36*	31*	84.4%	NAT	TACO ECM	225	\$2,444
XEB-3	XEB307503145303	75*	63*	55*	84.0%	NAT	TACO ECM	265	\$2,753
XEB-4	XEB411203145303	112.5*	95*	82*	84.0%	NAT	TACO ECM	322	\$3,035
XEB-5	XEB515003145303	150*	127*	109*	84.0%	NAT	TACO ECM	370	\$3,398
XEB-6	XEB618703145303	187.5*	158*	135*	84.0%	NAT	TACO ECM	431	\$3,982

XEB-2	XEB204203125303	42.5*	36*	31*	84.4%	NAT	GRUNDFOS	225	\$2,444
XEB-3	XEB307503125303	75*	63*	55*	84.0%	NAT	GRUNDFOS	265	\$2,753
XEB-4	XEB411203125303	112.5*	95*	82*	84.0%	NAT	GRUNDFOS	322	\$3,035
XEB-5	XEB515003125303	150*	127*	109*	84.0%	NAT	GRUNDFOS	370	\$3,398
XEB-6	XEB618703125303	187.5*	158*	135*	84.0%	NAT	GRUNDFOS	431	\$3,982

*** High Altitude - Capacity Reduces with Elevation. Refer to IOM for Actual Capacity Ratings.**

High Altitude Models ship with conversion kit (which must be field installed) at sea level with 5000' elevation orifices - consult factory for other elevations.

XEB (Use Parts Multiplier for All of the Following)

Model	Item Number	Description	Trade Price
XEB	550002722	NATURAL TO LP CONVERSION KIT (ALL SIZES)	\$96
XEB	43300660	LP TO NATURAL CONVERSION KIT (ALL SIZES)	\$105
XEB	14629014	4" THIMBLE (SIMPSON #915295)	\$46
XEB (2-5)	14629010	TJERNLUND VH-1-3" SIDE WALL VENT HOOD (XEB-2 TO XEB-5)	\$266
XEB (6)	14629011	TJERNLUND VH-1-4" SIDE WALL VENT HOOD (XEB-6)	\$316
XEB (2-5)	14624002	FILL-TROL #110 FOR WATER BOILERS 150 MBH OR LESS	\$337
XEB (6)	14624003	FILL-TROL #111 FOR WATER BOILERS OVER 150 MBH	\$467

**This page is intentionally left blank,
products continue on the following page.**

DXL-K Cast Iron Chimney Vented Boilers

- MBH Input 59 - 235 (CH)
- 84% AFUE
- Dependable Cast Iron Heat Exchanger
- Hydrostat Fuel Smart Control
- Digital temperature display and diagnostics
- Plug in connection for the vent damper
- Plug in connection for the system pump
- Control monitors water temperature and delays burner start until residual heat has been transferred to the system for maximum efficiency.



General Information (See IOM for Complete Instructions)							
Model	DXL-060K	DXL-095K	DXL-120K	DXL-150K	DXL-175K	DXL-205K	DXL-235K
Water Return/Supply	1 1/4" NPT						
Gas	1/2" NPT				3/4" NPT		
Electrical	120 Volts AC, 60 hertz, 1 phase, less than 12 amps (15 amp circuit recommended)						
Water Content (Gallons)	1.9	2.3	2.8	3.2	3.7	4.1	4.6
A-Height	32 1/8"	32 1/8"	32 1/8"	32 1/8"	32 1/8"	32 1/8"	32 1/8"
B-Width	13 3/8"	13 1/2"	16 1/4"	19"	21 7/8"	27 1/2"	27 1/2"
C-Depth	26"	26"	26"	26"	26"	26"	26"

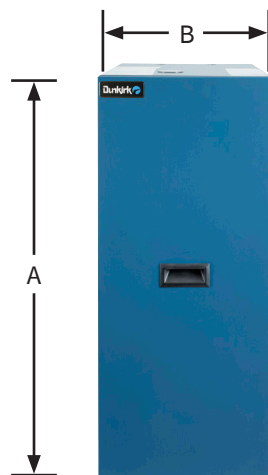

FRONT



LEFT SIDE

DXL-K - Cast Iron Chimney Vented Boilers

Model	Item Number	Input MBH	Htg. Cap. MBH	AHRI Net MBH	AFUE	Fuel	Pump	Shp. Wgt. lbs	Trade Price
DXL-060K	DXL306003200303	59	50	43	84.0%	NAT	LESS	215	\$2,421
DXL-095K	DXL409503200303	92.5	78	68	84.0%	NAT	LESS	245	\$2,600
DXL-120K	DXL512003200303	120	101	88	84.0%	NAT	LESS	305	\$2,777
DXL-150K	DXL615003200303	149	125	109	84.0%	NAT	LESS	335	\$3,019
DXL-175K	DXL717503200303	175	147	128	84.0%	NAT	LESS	395	\$3,501
DXL-205K	DXL820503200303	205	172	150	84.0%	NAT	LESS	435	\$3,751
DXL-235K	DXL923503200303	235	197	171	84.0%	NAT	LESS	465	\$4,233
DXL-060K	DXL306003240303	59	50	43	84.0%	NAT	TACO ECM	215	\$2,509
DXL-095K	DXL409503240303	92.5	78	68	84.0%	NAT	TACO ECM	245	\$2,688
DXL-120K	DXL512003240303	120	101	88	84.0%	NAT	TACO ECM	305	\$2,866
DXL-150K	DXL615003240303	149	125	109	84.0%	NAT	TACO ECM	335	\$3,107
DXL-175K	DXL717503240303	175	147	128	84.0%	NAT	TACO ECM	395	\$3,589
DXL-205K	DXL820503240303	205	172	150	84.0%	NAT	TACO ECM	435	\$3,839
DXL-235K	DXL923503240303	235	197	171	84.0%	NAT	TACO ECM	465	\$4,322
DXL-060K	DXL306003220303	59	50	43	84.0%	NAT	GRUNDFOS	215	\$2,509
DXL-095K	DXL409503220303	92.5	78	68	84.0%	NAT	GRUNDFOS	245	\$2,688
DXL-120K	DXL512003220303	120	101	88	84.0%	NAT	GRUNDFOS	305	\$2,866
DXL-150K	DXL615003220303	149	125	109	84.0%	NAT	GRUNDFOS	335	\$3,107
DXL-175K	DXL717503220303	175	147	128	84.0%	NAT	GRUNDFOS	395	\$3,589
DXL-205K	DXL820503220303	205	172	150	84.0%	NAT	GRUNDFOS	435	\$3,839
DXL-235K	DXL923503220303	235	197	171	84.0%	NAT	GRUNDFOS	465	\$4,322
DXL-060K	DXL306003230303	59	50	43	84.0%	NAT	B&G	215	\$2,509
DXL-095K	DXL409503230303	92.5	78	68	84.0%	NAT	B&G	245	\$2,688
DXL-120K	DXL512003230303	120	101	88	84.0%	NAT	B&G	305	\$2,866
DXL-150K	DXL615003230303	149	125	109	84.0%	NAT	B&G	335	\$3,107
DXL-175K	DXL717503230303	175	147	128	84.0%	NAT	B&G	395	\$3,589
DXL-205K	DXL820503230303	205	172	150	84.0%	NAT	B&G	435	\$3,839
DXL-235K	DXL923503230303	235	197	171	84.0%	NAT	B&G	465	\$4,322

DXL-K - LP

DXL-060K	DXL306013200303	59	50	43	84.0%	LP	LESS	215	\$2,476
DXL-095K	DXL409513200303	92.5	78	68	84.0%	LP	LESS	245	\$2,655
DXL-120K	DXL512013200303	120	101	88	84.0%	LP	LESS	305	\$2,833
DXL-150K	DXL615013200303	149	125	109	84.0%	LP	LESS	335	\$3,074
DXL-175K	DXL717513200303	175	147	128	84.0%	LP	LESS	395	\$3,556
DXL-205K	DXL820513200303	205	172	150	84.0%	LP	LESS	435	\$3,806
DXL-235K	DXL923513200303	235	197	171	84.0%	LP	LESS	465	\$4,289
DXL-060K	DXL306013240303	59	50	43	84.0%	LP	TACO ECM	215	\$2,564
DXL-095K	DXL409513240303	92.5	78	68	84.0%	LP	TACO ECM	245	\$2,744
DXL-120K	DXL512013240303	120	101	88	84.0%	LP	TACO ECM	305	\$2,921
DXL-150K	DXL615013240303	149	125	109	84.0%	LP	TACO ECM	335	\$3,163
DXL-175K	DXL717513240303	175	147	128	84.0%	LP	TACO ECM	395	\$3,644
DXL-205K	DXL820513240303	205	172	150	84.0%	LP	TACO ECM	435	\$3,894
DXL-235K	DXL923513240303	235	197	171	84.0%	LP	TACO ECM	465	\$4,377

DXL-K - Cast Iron Chimney Vented Boilers									
Model	Item Number	Input MBH	Htg. Cap. MBH	AHRI Net MBH	AFUE	Fuel	Pump	Shp. Wgt. lbs	Trade Price
DXL-060K	DXL306013220303	59	50	43	84.0%	LP	GRUNDFOS	215	\$2,564
DXL-095K	DXL409513220303	92.5	78	68	84.0%	LP	GRUNDFOS	245	\$2,744
DXL-120K	DXL512013220303	120	101	88	84.0%	LP	GRUNDFOS	305	\$2,921
DXL-150K	DXL615013220303	149	125	109	84.0%	LP	GRUNDFOS	335	\$3,163
DXL-175K	DXL717513220303	175	147	128	84.0%	LP	GRUNDFOS	395	\$3,644
DXL-205K	DXL820513220303	205	172	150	84.0%	LP	GRUNDFOS	435	\$3,894
DXL-235K	DXL923513220303	235	197	171	84.0%	LP	GRUNDFOS	465	\$4,377

DXL-K - High Altitude*									
DXL-060K	DXL306003245303	59*	50*	43*	84.0%	NAT	TACO ECM	215	\$2,509
DXL-095K	DXL409503245303	92.5*	78*	68*	84.0%	NAT	TACO ECM	245	\$2,688
DXL-120K	DXL512003245303	120*	101*	88*	84.0%	NAT	TACO ECM	305	\$2,866
DXL-150K	DXL615003245303	149*	125*	109*	84.0%	NAT	TACO ECM	335	\$3,107
DXL-175K	DXL717503245303	175*	147*	128*	84.0%	NAT	TACO ECM	395	\$3,589
DXL-205K	DXL820503245303	205*	172*	150*	84.0%	NAT	TACO ECM	435	\$3,839
DXL-235K	DXL923503245303	235*	197*	171*	84.0%	NAT	TACO ECM	465	\$4,322

* High Altitude - Capacity Reduces with Elevation. Refer to IOM for Actual Capacity Ratings.

High Altitude Models ship with conversion kit (which must be field installed) at sea level with 5000' elevation orifices - consult factory for other elevations.

DXL-K (Use Parts Multiplier for All of the Following)			
Model	Item Number	Description	Trade Price
DXL-K	550003778	CONVERSION KIT NAT. TO LP	\$78
DXL-K	550003884	CONVERSION KIT LP TO NAT.	\$85
DXL-K	14624002	FILL-TROL #110 FOR WATER BOILERS 150 MBH OR LESS	\$337
DXL-K	14624003	FILL-TROL #111 FOR WATER BOILERS OVER 150 MBH	\$467

**This page is intentionally left blank,
products continue on the following page.**

WPSB Cast Iron Integral Draft Diverter Boilers

- MBH Input 75 - 299 (CH)
- Up to 84.1% AFUE
- Dependable Cast Iron Heat Exchanger with Cast Iron Push Nipples
- Hydrolevel FuelSmart Control
- Digital temperature display and diagnostics
- Plug in connection for the vent damper
- Plug in connection for the system pump
- Low Water Cut Off (LWCO)
- Control monitors water temperature and delays burner start until residual heat has been transferred to the system for maximum efficiency



General Information (See IOM for Complete Instructions)							
Model	WPSB-3	WPSB-4	WPSB-5	WPSB-6	WPSB-7	WPSB-8	WPSB-9
Water Return/Supply	1 1/4" NPT						
Gas	1/2" NPT						
Electrical	120 Volts AC, 60 hertz, 1 phase, less than 12 amps (15 amp circuit recommended)						
Water Content (Gallons)	6.3	8.1	9.9	11.7	13.5	15.3	17.2
Dimensions	A-Height	36 3/8"	36 3/8"	36 3/8"	36 3/8"	36 3/8"	36 3/8"
	B-Width	11 1/4"	14 1/2"	17 3/4"	21"	24 1/4"	30 3/4"
	C-Depth	26 1/2"	26 1/2"	26 1/2"	26 1/2"	26 1/2"	26 1/2"

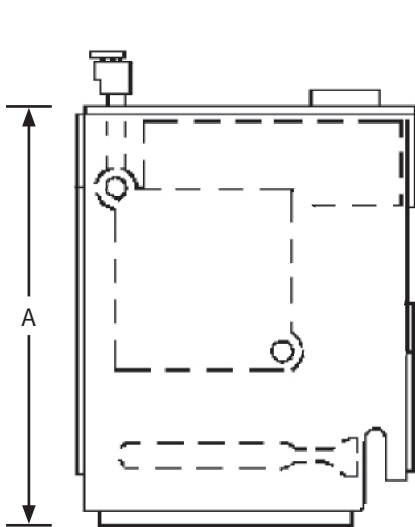

LEFT SIDE

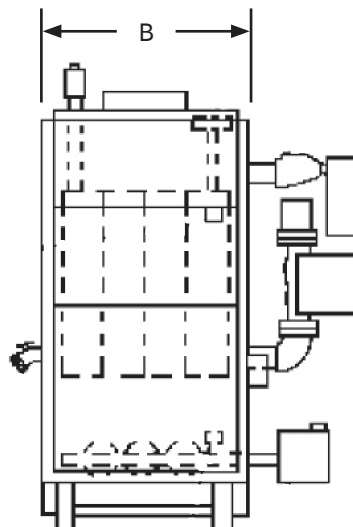

FRONT

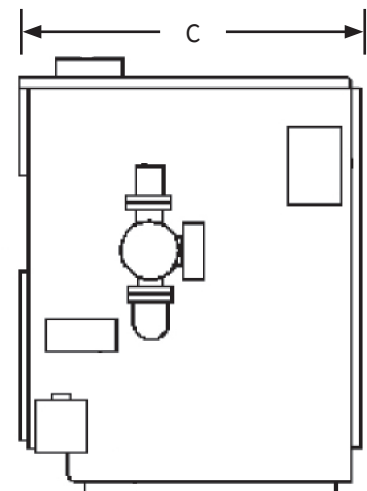

RIGHT SIDE

WPSB - Cast Iron Integral Draft Diverter Boilers									
Model	Item Number	Input MBH	Htg. Cap. MBH	AHRI Net MBH	AFUE	Fuel	Pump	Shp. Wgt. lbs	Trade Price
WPSB-3D	WPS307503200303	75	63	55	84.0%	NAT	LESS	315	\$2,680
WPSB-4D	WPS411203200303	112.5	94	82	84.0%	NAT	LESS	377	\$2,972
WPSB-5D	WPS515003200303	150	126	110	84.1%	NAT	LESS	453	\$3,280
WPSB-6D	WPS618703200303	187.5	157	137	84.1%	NAT	LESS	534	\$3,681
WPSB-7D	WPS722503200303	225	188	163	84.0%	NAT	LESS	601	\$4,028
WPSB-8D	WPS826203200303	262	221	191	84.0%	NAT	LESS	665	\$4,342
WPSB-9D	WPS929903200303	299	252	218	84.0%	NAT	LESS	750	\$5,017
WPSB-3D	WPS307503240303	75	63	55	84.0%	NAT	TACO ECM	315	\$2,761
WPSB-4D	WPS411203240303	112.5	94	82	84.0%	NAT	TACO ECM	377	\$3,054
WPSB-5D	WPS515003240303	150	126	110	84.1%	NAT	TACO ECM	453	\$3,361
WPSB-6D	WPS618703240303	187.5	157	137	84.1%	NAT	TACO ECM	534	\$3,763
WPSB-7D	WPS722503240303	225	188	163	84.0%	NAT	TACO ECM	601	\$4,110
WPSB-8D	WPS826203240303	262	221	191	84.0%	NAT	TACO ECM	665	\$4,424
WPSB-9D	WPS929903240303	299	252	218	84.0%	NAT	TACO ECM	750	\$5,100
WPSB-3D	WPS307503220303	75	63	55	84.0%	NAT	GRUNDFOS	315	\$2,761
WPSB-4D	WPS411203220303	112.5	94	82	84.0%	NAT	GRUNDFOS	377	\$3,054
WPSB-5D	WPS515003220303	150	126	110	84.1%	NAT	GRUNDFOS	453	\$3,361
WPSB-6D	WPS618703220303	187.5	157	137	84.1%	NAT	GRUNDFOS	534	\$3,763
WPSB-7D	WPS722503220303	225	188	163	84.0%	NAT	GRUNDFOS	601	\$4,110
WPSB-8D	WPS826203220303	262	221	191	84.0%	NAT	GRUNDFOS	665	\$4,424
WPSB-9D	WPS929903220303	299	252	218	84.0%	NAT	GRUNDFOS	750	\$5,100
WPSB-3D	WPS307503230303	75	63	55	84.0%	NAT	B&G	315	\$2,761
WPSB-4D	WPS411203230303	112.5	94	82	84.0%	NAT	B&G	377	\$3,054
WPSB-5D	WPS515003230303	150	126	110	84.1%	NAT	B&G	453	\$3,361
WPSB-6D	WPS618703230303	187.5	157	137	84.1%	NAT	B&G	534	\$3,763
WPSB-7D	WPS722503230303	225	188	163	84.0%	NAT	B&G	601	\$4,110
WPSB-8D	WPS826203230303	262	221	191	84.0%	NAT	B&G	665	\$4,424
WPSB-9D	WPS929903230303	299	252	218	84.0%	NAT	B&G	750	\$5,100
WPSB - LP									
WPSB-3DP	WPS307513200303	70	59	51	84.0%	LP	LESS	315	\$2,736
WPSB-4DP	WPS411213200303	105	88	77	84.0%	LP	LESS	377	\$3,028
WPSB-5DP	WPS515013200303	140	118	103	84.1%	LP	LESS	453	\$3,335
WPSB-6DP	WPS618713200303	175	147	128	84.1%	LP	LESS	534	\$3,738
WPSB-7DP	WPS722513200303	210	176	153	84.0%	LP	LESS	601	\$4,084
WPSB-8DP	WPS826213200303	245	208	179	84.0%	LP	LESS	665	\$4,399
WPSB-9DP	WPS929913200303	280	237	204	84.0%	LP	LESS	750	\$5,075
WPSB-3DP	WPS307513240303	70	59	51	84.0%	LP	TACO ECM	315	\$2,816
WPSB-4DP	WPS411213240303	105	88	77	84.0%	LP	TACO ECM	377	\$3,110
WPSB-5DP	WPS515013240303	140	118	103	84.1%	LP	TACO ECM	453	\$3,418
WPSB-6DP	WPS618713240303	175	147	128	84.1%	LP	TACO ECM	534	\$3,820
WPSB-7DP	WPS722513240303	210	176	153	84.0%	LP	TACO ECM	601	\$4,167
WPSB-8DP	WPS826213240303	245	208	179	84.0%	LP	TACO ECM	665	\$4,480
WPSB-9DP	WPS929913240303	280	237	204	84.0%	LP	TACO ECM	750	\$5,156

WPSB - Cast Iron Integral Draft Diverter Boilers (Cont.)

Model	Item Number	Input MBH	Htg. Cap. MBH	AHRI Net MBH	AFUE	Fuel	Pump	Shp. Wgt. lbs	Trade Price
WPSB-3DP	WPS307513220303	70	59	51	84.0%	LP	GRUNDFOS	315	\$2,816
WPSB-4DP	WPS411213220303	105	88	77	84.0%	LP	GRUNDFOS	377	\$3,110
WPSB-5DP	WPS515013220303	140	118	103	84.1%	LP	GRUNDFOS	453	\$3,418
WPSB-6DP	WPS618713220303	175	147	128	84.1%	LP	GRUNDFOS	534	\$3,820
WPSB-7DP	WPS722513220303	210	176	153	84.0%	LP	GRUNDFOS	601	\$4,167
WPSB-8DP	WPS826213220303	245	208	179	84.0%	LP	GRUNDFOS	665	\$4,480
WPSB-9DP	WPS929913220303	280	237	204	84.0%	LP	GRUNDFOS	750	\$5,156
WPSB-3DP	WPS307513230303	70	59	51	84.0%	LP	B&G	315	\$2,816
WPSB-4DP	WPS411213230303	105	88	77	84.0%	LP	B&G	377	\$3,110
WPSB-5DP	WPS515013230303	140	118	103	84.1%	LP	B&G	453	\$3,418
WPSB-6DP	WPS618713230303	175	147	128	84.1%	LP	B&G	534	\$3,820
WPSB-7DP	WPS722513230303	210	176	153	84.0%	LP	B&G	601	\$4,167
WPSB-8DP	WPS826213230303	245	208	179	84.0%	LP	B&G	665	\$4,480
WPSB-9DP	WPS929913230303	280	237	204	84.0%	LP	B&G	750	\$5,156

WPSB - High Altitude*

WPSB-3D	WPS307503245303	75*	63*	55*	84.0%	NAT	TACO ECM	315	\$2,761
WPSB-4D	WPS411203245303	112.5*	94*	82*	84.0%	NAT	TACO ECM	377	\$3,054
WPSB-5D	WPS515003245303	150*	126*	110*	84.1%	NAT	TACO ECM	453	\$3,361
WPSB-6D	WPS618703245303	187.5*	157*	137*	84.1%	NAT	TACO ECM	534	\$3,763
WPSB-7D	WPS722503245303	225*	188*	163*	84.0%	NAT	TACO ECM	601	\$4,110
WPSB-8D	WPS826203245303	262*	221*	191*	84.0%	NAT	TACO ECM	665	\$4,424
WPSB-9D	WPS929903245303	299*	252*	218*	84.0%	NAT	TACO ECM	750	\$5,100

*** High Altitude - Capacity Reduces with Elevation. Refer to IOM for Actual Capacity Ratings.**

WPSB (Use Parts Multiplier for All of the Following) Cont.

Model	Item Number	Description	Trade Price
WPSB	550004168	3-9 SECTION NATURAL GAS TO LP GAS CONVERSION KIT	\$105
WPSB-4D	43300632	4 SECTION LP GAS TO NATURAL GAS CONVERSION KIT	\$212
WPSB-5D	43300633	5 SECTION LP GAS TO NATURAL GAS CONVERSION KIT	\$215
WPSB-6D	43300634	6 SECTION LP GAS TO NATURAL GAS CONVERSION KIT	\$210
WPSB-7D	43300635	7 SECTION LP GAS TO NATURAL GAS CONVERSION KIT	\$212
WPSB-8D	43300636	8 SECTION LP GAS TO NATURAL GAS CONVERSION KIT	\$213
WPSB-9D	43300637	9 SECTION LP GAS TO NATURAL GAS CONVERSION KIT	\$213
WPSB	14624002	FILL-TROL FOR WATER BOILERS 150 MBH OR LESS	\$337
WPSB	14624003	FILL-TROL FOR WATER BOILERS OVER 150 MBH	\$467

**This page is intentionally left blank,
products continue on the following page.**

PSB Cast Iron Steam Boilers

- MBH Input 75 - 299 (CH)
- Up to 82.7% AFUE
- Dependable Cast Iron Heat Exchanger with Cast Iron Push Nipples
- LWCO (Probe Type) Includes Pressure High Limit Control, Pressure Gauge, Gauge Glass
- Low profile compact design makes it ideal for low clearance installations
- Easy piping features with 2" single and dual piping riser options (depending on boiler size), simplifying replacement piping
- Atmospheric Chimney Vent Boiler with Integral Draft Hood and Vent Damper
- Stainless Steel burner



General Information (See IOM for Complete Instructions)							
Model	PSB-3D	PSB-4D	PSB-5D	PSB-6D	PSB-7D	PSB-8D	PSB-9D
Return/Supply Tappings	2 1/2" NPT						
Gas	1/2" NPT			3/4" NPT			
Electrical	120 Volts AC, 60 hertz, 1 phase, less than 12 amps (15 amp circuit recommended)						
Water Content (Gallons)	2.6	3.8	5	6.2	7.4	8.6	9.5
Dimensions	A-Height	36 3/8"	36 3/8"	36 3/8"	36 3/8"	36 3/8"	36 3/8"
	B-Width	11 1/4"	14 1/2"	17 3/4"	21"	24 1/4"	30 3/4"
	C-Depth	26 1/2"	26 1/2"	26 1/2"	26 1/2"	26 1/2"	26 1/2"

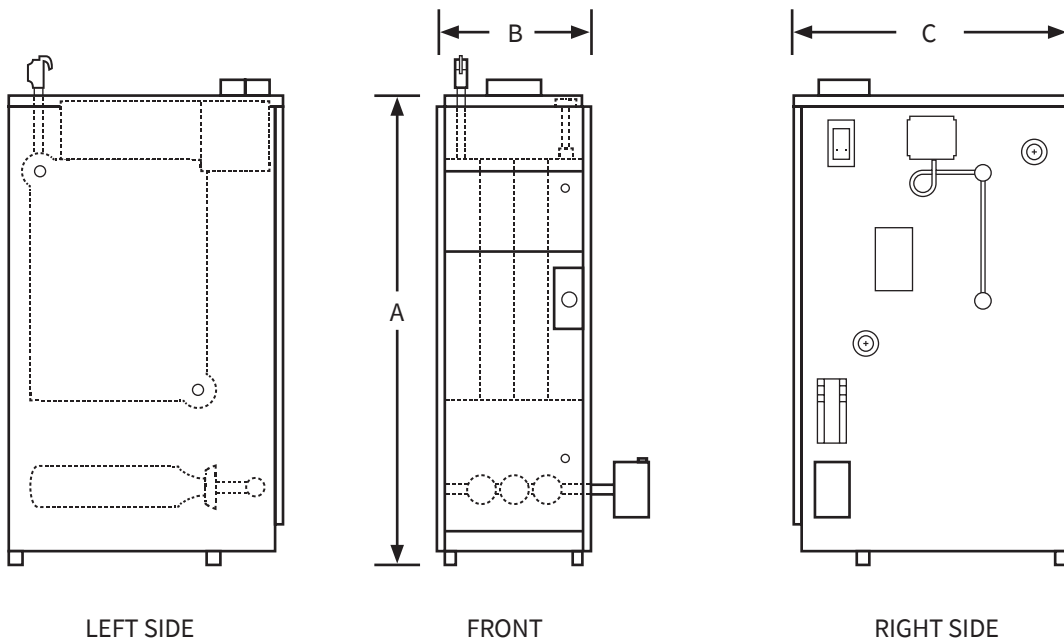

PSB - Cast Iron Steam Boilers									
Model	Item Number	Input MBH	Htg. Cap. MBH	AHRI Net MBH	AHRI Net SQ. FT. Steam	AFUE	Fuel	Shp. Wgt. lbs	Trade Price
PSB-3D	353001000	75	62	47	195	82.7%	NAT	297	\$3,125
PSB-4D	354001000	112	91	68	283	82.0%	NAT	368	\$3,413
PSB-5D	355001000	150	122	92	383	82.0%	NAT	440	\$3,847
PSB-6D	356001000	187	153	115	479	82.0%	NAT	512	\$4,382
PSB-7D	357001000	225	183	137	570	82.0%	NAT	584	\$4,831
PSB-8D	358001000	262	214	161	670	82.0%	NAT	659	\$5,342
PSB-9D	359001000	299	245	184	766	82.0%	NAT	736	\$5,627

PSB (Use Parts Multiplier for All of the Following)			
Model	Item Number	Description	Trade Price
PSB-3D	43300723	3 SECTION NATURAL GAS TO LP GAS CONVERSION KIT	\$57
PSB-4D	43300724	4 SECTION NATURAL GAS TO LP GAS CONVERSION KIT	\$57
PSB-5D	43300725	5 SECTION NATURAL GAS TO LP GAS CONVERSION KIT	\$57
PSB-6D	43300726	6 SECTION NATURAL GAS TO LP GAS CONVERSION KIT	\$67
PSB-7D	43300727	7 SECTION NATURAL GAS TO LP GAS CONVERSION KIT	\$67
PSB-8D	43300728	8 SECTION NATURAL GAS TO LP GAS CONVERSION KIT	\$67
PSB-9D	43300729	9 SECTION NATURAL GAS TO LP GAS CONVERSION KIT	\$67
PSB-4D	43300632	4 SECTION LP TO NATURAL GAS CONVERSION KIT	\$212
PSB-5D	43300633	5 SECTION LP TO NATURAL GAS CONVERSION KIT	\$215
PSB-6D	43300634	6 SECTION LP TO NATURAL GAS CONVERSION KIT	\$210
PSB-7D	43300635	7 SECTION LP TO NATURAL GAS CONVERSION KIT	\$212
PSB-8D	43300636	8 SECTION LP TO NATURAL GAS CONVERSION KIT	\$213
PSB-9D	43300637	9 SECTION LP TO NATURAL GAS CONVERSION KIT	\$213
PSB	1630001	MCDONNELL & MILLER WF-2U-24 ELECTRONIC WATER FEEDER	\$538

D249 Cast Iron Commercial Steam Boilers

D249 Boiler Bases are pre-assembled at the factory with burner manifold, burner orifices, gas valves and electronic ignition installed; ready for field installation of the pre-tested sections and appropriate packages.

Electronic Ignition Base Standard Equipment:

- Base
- Fire Door
- Burner Orifice
- Manifold
- Main and Pilot Burner
- Electronic Pilot Gas Valve
- Intermittent Pilot Module
- Complete Jacket Assembly

Steam Trim Package:

- Low Water Cut-Off
- Glass Gauge Set
- Safety Valve
- Steam Gauge
- Pressure Limit
- Drain Valve



Plug 'N Play Harness and Junction Box

Individual base and junction box controls are designed for easy installation. The entire boiler links together in a snap with a color-coded factory supplied wiring harness

CSD-1 Options

Available with a CSD-1 option to comply with CSD-1 standards where required by building code. The CSD-1 option provides the increased number of controls and safety devices required to meet CSD-1 standards.

General Information (See IOM for Complete Instructions)			
	Right & Left End Tappings	Opening	Size
	Return/Supply	A	4"
	Primary LWCO & Guage Glass Set	B	1/2"
	Drain, Left End	C	3/4"
	Drain, Right End	C	3/4"
	Plugged	D	1/2"
	Accessories	E	1"
	Safety Valve	F*	1"
	Plugged or Electronic (Probe Type) LWCO	G	3/4"
	*If using opening F for other than Safety Valve or Safety Relief Valve, or Safety/Relief valve is larger than 1", Install Safety/Relief Valve in Header Piping as near boiler as possible.		

D249 - Cast Iron Commercial Steam Boiler

Model	Item Number	Type*	Input MBH	Output MBH	Net AHRI Steam PPF	Net AHRI Steam SQ. FT.	Net AHRI Steam MBH	Therm. Eff.	Shp. Wgt. Lbs.	Trade Price
D249-300	CBA030003101103	STD.	300	233	1.33	729	175	77.0%	1000	\$9,211
D249-400	CBA040003101103	STD.	400	310	1.33	971	233	77.0%	1200	\$10,365
D249-500	CBA050003101103	STD.	500	388	1.33	1213	291	77.0%	1400	\$11,521
D249-600	CBA060003101103	STD.	600	465	1.33	1454	349	77.0%	1600	\$14,980
D249-700	CBA070003101103	STD.	700	543	1.33	1696	407	77.0%	1800	\$16,138
D249-800	CBA080003101103	STD.	800	620	1.33	1938	465	77.0%	2000	\$17,338
D249-900	CBA090003101103	STD.	900	698	1.33	2183	524	77.0%	2200	\$18,611
D249-1000	CBA100003101103	STD.	1000	775	1.33	2421	581	77.0%	2400	\$19,756
D249-1100	CBA110003101103	STD.	1100	853	1.33	2667	640	77.0%	2600	\$23,272
D249-1200	CBA120003101103	STD.	1200	930	1.33	2908	698	77.0%	2900	\$24,465
D249-1300	CBA130003101103	STD.	1300	1008	1.33	3150	756	77.0%	3100	\$26,292
D249-1400	CBA140003101103	STD.	1400	1085	1.33	3392	814	77.0%	3300	\$27,450
D249-1500	CBA150003101103	STD.	1500	1163	1.33	3633	872	77.0%	3500	\$28,632
D249-300	CBA030003103103	G.R.S.	300	233	1.33	729	175	77.0%	1000	\$10,284
D249-400	CBA040003103103	G.R.S.	400	310	1.33	971	233	77.0%	1200	\$11,437
D249-500	CBA050003103103	G.R.S.	500	388	1.33	1213	291	77.0%	1400	\$12,592
D249-600	CBA060003103103	G.R.S.	600	465	1.33	1454	349	77.0%	1600	\$17,268
D249-700	CBA070003103103	G.R.S.	700	543	1.33	1696	407	77.0%	1800	\$18,446
D249-800	CBA080003103103	G.R.S.	800	620	1.33	1938	465	77.0%	2000	\$19,603
D249-900	CBA090003103103	G.R.S.	900	698	1.33	2183	524	77.0%	2200	\$20,913
D249-1000	CBA100003103103	G.R.S.	1000	775	1.33	2421	581	77.0%	2400	\$22,064
D249-1100	CBA110003103103	G.R.S.	1100	853	1.33	2667	640	77.0%	2600	\$26,077
D249-1200	CBA120003103103	G.R.S.	1200	930	1.33	2908	698	77.0%	2900	\$27,248
D249-1300	CBA130003103103	G.R.S.	1300	1008	1.33	3150	756	77.0%	3100	\$29,071
D249-1400	CBA140003103103	G.R.S.	1400	1085	1.33	3392	814	77.0%	3300	\$30,233
D249-1500	CBA150003103103	G.R.S.	1500	1163	1.33	3633	872	77.0%	3500	\$31,375
D249-300	CBA030003104103	F.P.R.	300	233	1.33	729	175	77.0%	1000	\$11,386
D249-400	CBA040003104103	F.P.R.	400	310	1.33	971	233	77.0%	1200	\$12,538
D249-500	CBA050003104103	F.P.R.	500	388	1.33	1213	291	77.0%	1400	\$13,693
D249-600	CBA060003104103	F.P.R.	600	465	1.33	1454	349	77.0%	1600	\$18,367
D249-700	CBA070003104103	F.P.R.	700	543	1.33	1696	407	77.0%	1800	\$19,546
D249-800	CBA080003104103	F.P.R.	800	620	1.33	1938	465	77.0%	2000	\$20,711
D249-900	CBA090003104103	F.P.R.	900	698	1.33	2183	524	77.0%	2200	\$22,015
D249-1000	CBA100003104103	F.P.R.	1000	775	1.33	2421	581	77.0%	2400	\$23,166
D249-1100	CBA110003104103	F.P.R.	1100	853	1.33	2667	640	77.0%	2600	\$27,178
D249-1200	CBA120003104103	F.P.R.	1200	930	1.33	2908	698	77.0%	2900	\$28,349
D249-1300	CBA130003104103	F.P.R.	1300	1008	1.33	3150	756	77.0%	3100	\$30,174
D249-1400	CBA140003104103	F.P.R.	1400	1085	1.33	3392	814	77.0%	3300	\$31,334
D249-1500	CBA150003104103	F.P.R.	1500	1163	1.33	3633	872	77.0%	3500	\$32,476

***(STD. - Standard) (G.R.S. - CSD-1 Gravity Return System) (F.P.R. - CSD-1 Boiler Feed Pump Return Control)**

D249 - Knock Down Components & Optional Equipment			
Model	Item Number	Description	Trade Price
D249	41154050D	CAST IRON SECTIONS - RIGHT END (179 LBS.)	\$1,036
D249	41154051D	CAST IRON SECTIONS - LEFT END (182 LBS.)	\$1,036
D249	41154052D	CAST IRON SECTIONS - INTERMEDIATE (165 LBS.)	\$903
D249-300	550002861D	COMPONENT CARTON - 300	\$2,755
D249-400	550002862D	COMPONENT CARTON - 400	\$2,918
D249-500	550002863D	COMPONENT CARTON - 500	\$3,062
D249-300	550002890D	COMPONENT CARTON - 300 CSD-1	\$3,216
D249-400	550002891D	COMPONENT CARTON - 400 CSD-1	\$3,380
D249-500	550002892D	COMPONENT CARTON - 500 CSD-1	\$3,524
D249	550002871D	END PANEL CARTON - JACKET	\$401
D249	550002860D	END PANEL CARTON - BASE	\$362
D249	41200061D	STEAM TRIM - SA 1 (SIZES/MODELS: 300 -500)	\$1,346
D249	41200062D	STEAM TRIM - SA 2 (SIZES/MODELS: 600 - 700)	\$1,364
D249	41200063D	STEAM TRIM - SA 3 (SIZES/MODELS: 800 - 1400)	\$1,400
D249	41200064D	STEAM TRIM - SA 4 (SIZES/MODELS: 1500)	\$1,414
D249-300	550002877DS	ACCESSORY CARTON - 300	\$470
D249-400	550002878DS	ACCESSORY CARTON - 400	\$557
D249-500	550002867DS	ACCESSORY CARTON - 500	\$667
D249-600	550002879DS	ACCESSORY CARTON - 600	\$755
D249-700	550002880DS	ACCESSORY CARTON - 700	\$846
D249-800	550002881DS	ACCESSORY CARTON - 800	\$981
D249-900	550002882DS	ACCESSORY CARTON - 900	\$1,167
D249-1000	550002868DS	ACCESSORY CARTON - 1000	\$1,271
D249-1100	550002883DS	ACCESSORY CARTON - 1100	\$1,452
D249-1200	550002884DS	ACCESSORY CARTON - 1200	\$1,528
D249-1300	550002885DS	ACCESSORY CARTON - 1300	\$2,326
D249-1400	550002886DS	ACCESSORY CARTON - 1400	\$2,419
D249-1500	550002869DS	ACCESSORY CARTON - 1500	\$2,554
D249	41257103D	CSD-1 STEAM TRIM - GRAVITY/CONDENSATE (ALL SIZES)	\$610
D249	41257104D	CSD-1 STEAM TRIM - FEED PUMP (ALL SIZES)	\$1,713
D249-300	550002893DS	CSD-1 ACCESSORY CARTON - 300	\$470
D249-400	550002894DS	CSD-1 ACCESSORY CARTON - 400	\$557
D249-500	550002895DS	CSD-1 ACCESSORY CARTON - 500	\$667
D249-600	550002896DS	CSD-1 ACCESSORY CARTON - 600	\$1,509
D249-700	550002897DS	CSD-1 ACCESSORY CARTON - 700	\$1,621
D249-800	550002898DS	CSD-1 ACCESSORY CARTON - 800	\$1,719
D249-900	550002899DS	CSD-1 ACCESSORY CARTON - 900	\$1,941
D249-1000	550002900DS	CSD-1 ACCESSORY CARTON - 1000	\$2,045
D249-1100	550002901DS	CSD-1 ACCESSORY CARTON - 1100	\$2,227
D249-1200	550002902DS	CSD-1 ACCESSORY CARTON - 1200	\$2,316
D249-1300	550002903DS	CSD-1 ACCESSORY CARTON - 1300	\$3,114
D249-1400	550002904DS	CSD-1 ACCESSORY CARTON - 1400	\$3,207
D249-1500	550002905DS	CSD-1 ACCESSORY CARTON - 1500	\$3,302

D249 (Use Parts Multiplier for All of the Following)

Model	Item Number	Description	Trade Price
D249	14662311	STEAM MANUAL RESET PRESSURE CONTROL (L4079B1033)	\$308
D249	1280001	M-M 47-2 LWCO & FEEDER (MODELS 300-1500)	\$1,384
D249	14662313	STRAP ON OPERATING CONTROL (L6006C-1034)	\$185
D249	240007388	LWCO, MAN RESET, CSD-1 APPROVED, SHT PROBE	\$245

D249 - Standard Equipment

Standard Equipment:

(67 Low Water Cut-Off, PA404A Pressuretrol and Syphon Loop, Water Gauge Glass Set with Glass and Rods, Steam Gauge, Pop Safety Valve).

CSD-1 Control Requirements

The optional CSD-1 controls modify the standard D249 boiler on both the fuel train and the steam trim as follows:

Steam Boiler with Boiler Feed Pump Return System

- Add SF-500 Hydrolevel Safeguard Manual Reset L.W.C.O.
- Add 150S-B-MD L.W.C.O. and Pump Control
- Delete 67D-1 L.W.C.O.
- Add L404L Manual Reset Pressure Control

Steam Boiler with Gravity or Condensate Pump Return

- Add SF-500 Hydrolevel Safeguard Manual Reset L.W.C.O.
- Add L404C Manual Reset Pressure Control

The SF-500 L.W.C.O. is the secondary L.W.C.O. to the 67D-1 L.W.C.O. furnished standard with the boiler.

Fuel Train

Substitute CSD-1 fuel train(s) for standard which includes (per base): Intermittent Pilot Module (PT#1140007) control Stop w/alarm 1003-612A & (PT#1140008) Control CSD1 Lockout Board BD 1145-2 with manual reset; Independent Pilot Gas Line (Manual shut-off valve, Pressure regulator, Safety shut-off valve); Main Gas Line (Gas Valve, Two leak test cocks, Manual shut-off downstream of the main gas valve).

Notes:

1. The D249-300 and D249-400 do not require fuel train modifications for CSD-1. The standard fuel train is furnished.
2. Control equipment is included to meet Utica's interpretation of CSD-1. Consult local authorities before the installation of the boiler. Additional controls, if required can be provided at an additional price.

EXCELSIOR EXB Cast Iron 3-Pass Oil Boilers

- MBH Input 105 - 231
- Up to 87% AFUE, ENERGY STAR® Certified Models
- Advanced High Efficiency 3-Pass Heat Exchanger Design
- High Limit Control with:
 - LED display
 - Easy to program dial settings
 - Boiler Water Temperature Reset
 - Low Water Cut Off (LWCO)
- Compact Footprint
- Burners and Venting Options (Burner cover standard)
- Easy Serviceability



General Information (See IOM for Complete Instructions)				
Model	EXB4	EXB5	EXB6	EXB7
Water Return/Supply	1 1/4" NPT			
Drain Valve	3/4" NPT			
Electrical	120 Volts AC, 60 hertz, 1 phase, less than 12 amps (15 amp circuit recommended)			
Water Content (Gallons)	3.6	4.3	5.1	5.9
Dimensions	A-Height	31"	31"	31"
	B-Width	17 3/4"	17 3/4"	17 3/4"
	C-Depth	18 3/8"	21 5/8"	24 7/8"

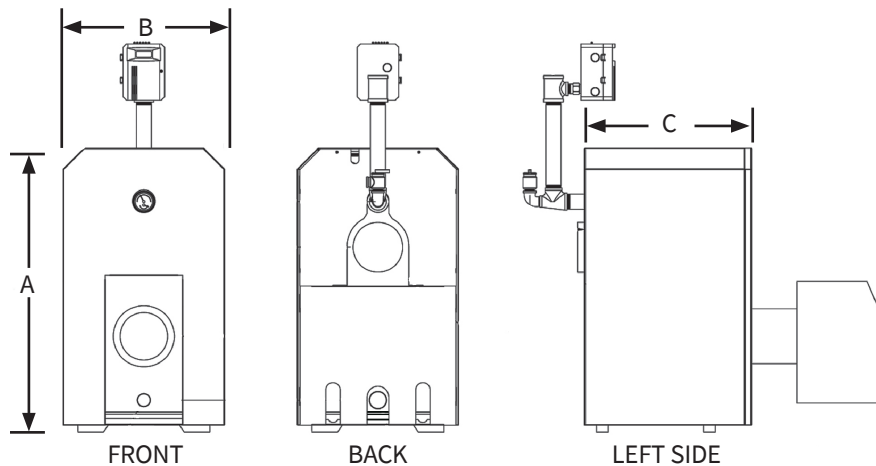

DHW MODULE Domestic Hot Water Module (Sold Separately)

- The Domestic Hot Water (DHW) Module is a great way to make domestic hot water using an existing boiler
- Digital control has the ability to set a consistent DHW temperature from 108°F - 140°F
- Brazed plate stainless steel heat exchanger offers lower pressure drop than tankless water coils with nearly 100% heat transfer efficiency
- Simple and flexible installation - mounts on a wall near the boiler as an additional heating zone
- Compact design with insulated cover and a standard 120 volt power cord
- Easy to service and clean



EXCELSIOR EXB - Cast Iron 3-Pass Oil Boiler

Model	Item Number	Input MBH	Htg. Cap. MBH	AHRI Net MBH	AFUE	Fuel	Burner	Pump	Shp. Wgt. lbs	Trade Price
EXB4075	EXB407530200303	105	92	80	87.0%	OIL	BECKETT	LESS	436	\$2,765
EXB4090	EXB409030200303	126	110	96	86.0%	OIL	BECKETT	LESS	436	\$2,765
EXB5100	EXB510030200303	140	123	107	87.0%	OIL	BECKETT	LESS	496	\$3,151
EXB6130	EXB613030200303	182	160	139	87.0%	OIL	BECKETT	LESS	560	\$3,324
EXB7165	EXB716530200303	231	202	176	87.0%	OIL	BECKETT	LESS	620	\$3,792
EXB4075	EXB407530240303	105	92	80	87.0%	OIL	BECKETT	TACO ECM	436	\$2,848
EXB4090	EXB409030240303	126	110	96	86.0%	OIL	BECKETT	TACO ECM	436	\$2,848
EXB5100	EXB510030240303	140	123	107	87.0%	OIL	BECKETT	TACO ECM	496	\$3,237
EXB6130	EXB613030240303	182	160	139	87.0%	OIL	BECKETT	TACO ECM	560	\$3,409
EXB7165	EXB716530240303	231	202	176	87.0%	OIL	BECKETT	TACO ECM	620	\$3,878
EXB4075	EXB407530220303	105	92	80	87.0%	OIL	BECKETT	GRUNDFOS	436	\$2,848
EXB4090	EXB409030220303	126	110	96	86.0%	OIL	BECKETT	GRUNDFOS	436	\$2,848
EXB5100	EXB510030220303	140	123	107	87.0%	OIL	BECKETT	GRUNDFOS	496	\$3,237
EXB6130	EXB613030220303	182	160	139	87.0%	OIL	BECKETT	GRUNDFOS	560	\$3,409
EXB7165	EXB716530220303	231	202	176	87.0%	OIL	BECKETT	GRUNDFOS	620	\$3,878
EXB4075	EXB407550200303	105	92	80	87.0%	OIL	RIELLO	LESS	436	\$2,839
EXB4090	EXB409050200303	126	110	96	86.0%	OIL	RIELLO	LESS	436	\$2,839
EXB5100	EXB510050200303	140	123	107	87.0%	OIL	RIELLO	LESS	496	\$3,275
EXB6130	EXB613050200303	182	160	139	87.0%	OIL	RIELLO	LESS	560	\$3,447
EXB7165	EXB716550200303	231	202	176	87.0%	OIL	RIELLO	LESS	620	\$3,855
EXB4075	EXB407550240303	105	92	80	87.0%	OIL	RIELLO	TACO ECM	436	\$2,925
EXB4090	EXB409050240303	126	110	96	86.0%	OIL	RIELLO	TACO ECM	436	\$2,925
EXB5100	EXB510050240303	140	123	107	87.0%	OIL	RIELLO	TACO ECM	496	\$3,362
EXB6130	EXB613050240303	182	160	139	87.0%	OIL	RIELLO	TACO ECM	560	\$3,534
EXB7165	EXB716550240303	231	198	172	84.0%	OIL	RIELLO	TACO ECM	560	\$3,941
EXB4075	EXB407550220303	105	92	80	87.0%	OIL	RIELLO	GRUNDFOS	436	\$2,925
EXB4090	EXB409050220303	126	110	96	86.0%	OIL	RIELLO	GRUNDFOS	436	\$2,925
EXB5100	EXB510050220303	140	123	107	87.0%	OIL	RIELLO	GRUNDFOS	496	\$3,362
EXB6130	EXB613050220303	182	160	139	87.0%	OIL	RIELLO	GRUNDFOS	560	\$3,534
EXB7165	EXB716550220303	231	202	176	87.0%	OIL	RIELLO	GRUNDFOS	620	\$3,941
EXB4090	EXB409020240303	126	110	96	86.0%	OIL	LESS	TACO ECM	436	\$2,109
EXB5100	EXB510020240303	140	123	107	87.0%	OIL	LESS	TACO ECM	496	\$2,458
EXB6130	EXB613020240303	182	160	139	87.0%	OIL	LESS	TACO ECM	560	\$2,700
EXB7165	EXB716520240303	231	202	176	87.0%	OIL	LESS	TACO ECM	620	\$3,110
EXB4090	EXB409020220303	126	110	96	86.0%	OIL	LESS	GRUNDFOS	436	\$2,109
EXB5100	EXB510020220303	140	123	107	87.0%	OIL	LESS	GRUNDFOS	496	\$2,458
EXB6130	EXB613020220303	182	160	139	87.0%	OIL	LESS	GRUNDFOS	560	\$2,700
EXB7165	EXB716520220303	231	202	176	87.0%	OIL	LESS	GRUNDFOS	620	\$3,110
EXB4090	EXB409020200303	126	110	96	86.0%	OIL	LESS	LESS	436	\$2,025
EXB5100	EXB510020200303	140	123	107	87.0%	OIL	LESS	LESS	496	\$2,371
EXB6130	EXB613020200303	182	160	139	87.0%	OIL	LESS	LESS	560	\$2,614
EXB7165	EXB716520200303	231	202	176	87.0%	OIL	LESS	LESS	620	\$3,023

EXCELSIOR EXB - Venting Options & Additional Equipment

Model	Item Number	Description	Trade Price
EXB	29231D	36" RISER TERMINATION	\$1,199
EXB	28972D	STANDARD TERMINATION	\$511
EXB	550004240U	4" ID X 10 FT DIRECT VENT PIPE KIT (SELECT TERMINATION)	\$668
EXB	550004241U	4" ID X 15 FT DIRECT VENT PIPE KIT (SELECT TERMINATION)	\$800
EXB	550004242U	4" ID X 20 FT DIRECT VENT PIPE KIT (SELECT TERMINATION)	\$944

EXCELSIOR EXB - Replacement Oil Burners

EXB4075	240007232D	BECKETT CHIMNEY VENT W/O COVER MODEL AFG	\$663
EXB4090	240013303D	BECKETT CHIMNEY VENT W/O COVER MODEL AFG	\$663
EXB5100	240007233D	BECKETT CHIMNEY VENT W/O COVER MODEL AFG	\$703
EXB6130	240007234D	BECKETT CHIMNEY VENT W/O COVER MODEL AFG	\$634
EXB7165	240007235D	BECKETT CHIMNEY VENT W/O COVER MODEL AFG	\$695
EXB4075	240007144D	BECKETT CHIMNEY VENT WITH COVER MODEL AFG	\$712
EXB4090	240013302D	BECKETT CHIMNEY VENT WITH COVER MODEL AFG	\$712
EXB5100	240007145D	BECKETT CHIMNEY VENT WITH COVER MODEL AFG	\$750
EXB6130	240007146D	BECKETT CHIMNEY VENT WITH COVER MODEL AFG	\$682
EXB7165	240007183D	BECKETT CHIMNEY VENT WITH COVER MODEL AFG	\$740
EXB4075	550004238D	BECKETT DIRECT VENT MODEL NX	\$849
EXB5100	240007532D	BECKETT DIRECT VENT MODEL NX	\$885
EXB6130	240007533D	BECKETT DIRECT VENT MODEL NX	\$818
EXB4075	550003548D	RIELLO CHIMNEY VENT MODEL 40F	\$785
EXB4090	550004237D	RIELLO CHIMNEY VENT MODEL 40F	\$785
EXB5100	550003551D	RIELLO CHIMNEY VENT MODEL 40F	\$872
EXB6130	550003554D	RIELLO CHIMNEY VENT MODEL 40F	\$801
EXB7165	550003557D	RIELLO CHIMNEY VENT MODEL 40F	\$801
EXB4075	550004239D	RIELLO DIRECT VENT MODEL 40BF	\$1,144
EXB5100	550003563D	RIELLO DIRECT VENT MODEL 40BF	\$1,230
EXB6130	550003566D	RIELLO DIRECT VENT MODEL 40BF	\$1,162
EXB4	240013299D	CARLIN CHIMNEY VENT MODEL EZ-LF (4075 & 4090)	\$717
EXB5100	240013299D	CARLIN CHIMNEY VENT MODEL EZ-LF (5100)	\$717

EXCELSIOR EXB (Use Parts Multiplier for All of the Following)

EXB	550001929	KIT, HIGH LIMIT MANUAL RESET L4006E1109 WITH PLUG IN HARNESS	\$256
EXB	14624002	FILL-TROL FOR WATER BOILERS 150 MBH OR LESS	\$337
EXB	14624003	FILL-TROL FOR WATER BOILERS OVER 150 MBH	\$467

DHW Module

Model	Item Number	Description	Trade Price
550003792	550003792D	DOMESTIC HOT WATER MODULE	\$945

**This page is intentionally left blank,
products continue on the following page.**

EMPIRE EWC Cast Iron Chimney Vented Oil Boilers

- MBH Input 112 - 217 (CH)
- Up to 86.2% AFUE
- Cast Iron Heat Exchanger with Cast Iron Push Nipples
- Swing out Burner Door
- Hydrolevel Operating Control
 - Digital display and diagnostics
 - Adjusts water temperature based on your heating system demand
 - Built-in Low Water Cut Off (LWCO)
- Optional Tankless Domestic Water Heater Coil



General Information (See IOM for Complete Instructions)				
Model	3EWC	4EWC	5EWC	
Water Return/Supply	1 1/4" NPT			
Optional Tankless Coil	1/2" NPT			
Electrical	120 Volts AC, 60 hertz, 1 phase, less than 12 amps (15 amp circuit recommended)			
Water Content (Gallons)	9.6	11.6	13.7	
Dimensions	A-Height	36"	36"	36"
	B-Width	20 1/2"	20 1/2"	20 1/2"
	C-Depth	14 1/2"	17 3/4"	21"

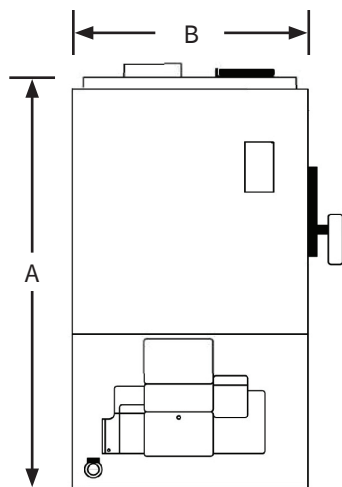

FRONT

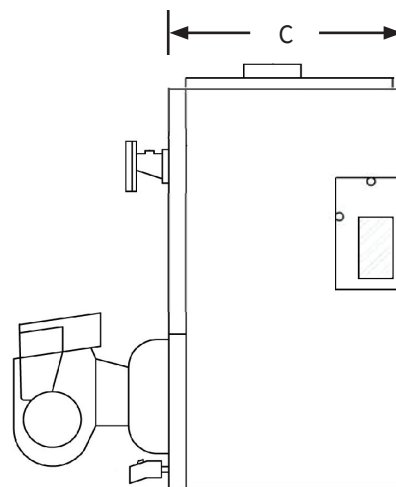

RIGHT SIDE

EMPIRE EWC - Cast Iron Chimney Vent Oil Boiler

Model	Item Number	Type	Input MBH	Htg. Cap. MBH	AHRI Net MBH	AFUE	Burner	Pump	Fire Rate GPH	Coil GPM	Shp. Wgt. lbs	Trade Price
3EWC0.80	EWC308031200103	LESS	112	98	85	86.0%	BECKETT	LESS	0.80	N/A	470	\$3,058
4EWC1.00	EWC410031200103	LESS	140	122	106	86.2%	BECKETT	LESS	1.00	N/A	545	\$3,231
4EWC1.25	EWC412531200103	LESS	175	152	132	86.0%	BECKETT	LESS	1.25	N/A	545	\$3,231
5EWC1.55	EWC515531200103	LESS	217	189	164	86.0%	BECKETT	LESS	1.55	N/A	630	\$4,488
3EWC0.80T	EWC308032200103	COIL	112	98	85	86.0%	BECKETT	LESS	0.80	3.05	470	\$3,599
4EWC1.00T	EWC410032200103	COIL	140	122	106	86.2%	BECKETT	LESS	1.00	3.25	545	\$3,771
4EWC1.25T	EWC412532200103	COIL	175	152	132	86.0%	BECKETT	LESS	1.25	3.50	545	\$3,771
5EWC1.55T	EWC515532200103	COIL	217	189	164	86.0%	BECKETT	LESS	1.55	3.80	630	\$5,023
3EWC0.80	EWC308031240103	LESS	112	98	85	86.0%	BECKETT	TACO ECM	0.80	N/A	470	\$3,102
4EWC1.00	EWC410031240103	LESS	140	122	106	86.2%	BECKETT	TACO ECM	1.00	N/A	545	\$3,275
4EWC1.25	EWC412531240103	LESS	175	152	132	86.0%	BECKETT	TACO ECM	1.25	N/A	545	\$3,275
5EWC1.55	EWC515531240103	LESS	217	189	164	86.0%	BECKETT	TACO ECM	1.55	N/A	630	\$4,532
3EWC0.80T	EWC308032240103	COIL	112	98	85	86.0%	BECKETT	TACO ECM	0.80	3.05	470	\$3,643
4EWC1.00T	EWC410032240103	COIL	140	122	106	86.2%	BECKETT	TACO ECM	1.00	3.25	545	\$3,815
4EWC1.25T	EWC412532240103	COIL	175	152	132	86.0%	BECKETT	TACO ECM	1.25	3.50	545	\$3,815
5EWC1.55T	EWC515532240103	COIL	217	189	164	86.0%	BECKETT	TACO ECM	1.55	3.80	630	\$5,067
3EWC0.80	EWC308031220103	LESS	112	98	85	86.0%	BECKETT	GRUNDFOS	0.80	N/A	470	\$3,102
4EWC1.00	EWC410031220103	LESS	140	122	106	86.2%	BECKETT	GRUNDFOS	1.00	N/A	545	\$3,275
4EWC1.25	EWC412531220103	LESS	175	152	132	86.0%	BECKETT	GRUNDFOS	1.25	N/A	545	\$3,275
5EWC1.55	EWC515531220103	LESS	217	189	164	86.0%	BECKETT	GRUNDFOS	1.55	N/A	630	\$4,532
3EWC0.80T	EWC308032220103	COIL	112	98	85	86.0%	BECKETT	GRUNDFOS	0.80	3.05	470	\$3,643
4EWC1.00T	EWC410032220103	COIL	140	122	106	86.2%	BECKETT	GRUNDFOS	1.00	3.25	545	\$3,815
4EWC1.25T	EWC412532220103	COIL	175	152	132	86.0%	BECKETT	GRUNDFOS	1.25	3.50	545	\$3,815
5EWC1.55T	EWC515532220103	COIL	217	189	164	86.0%	BECKETT	GRUNDFOS	1.55	3.80	630	\$5,067
3EWC0.80	EWC308031230103	LESS	112	98	85	86.0%	BECKETT	B&G	0.80	N/A	470	\$3,102
4EWC1.00	EWC410031230103	LESS	140	122	106	86.2%	BECKETT	B&G	1.00	N/A	545	\$3,275
4EWC1.25	EWC412531230103	LESS	175	152	132	86.0%	BECKETT	B&G	1.25	N/A	545	\$3,275
5EWC1.55	EWC515531230103	LESS	217	189	164	86.0%	BECKETT	B&G	1.55	N/A	630	\$4,532
3EWC0.80T	EWC308032230103	COIL	112	98	85	86.0%	BECKETT	B&G	0.80	3.05	470	\$3,643
4EWC1.00T	EWC410032230103	COIL	140	122	106	86.2%	BECKETT	B&G	1.00	3.25	545	\$3,815
4EWC1.25T	EWC412532230103	COIL	175	152	132	86.0%	BECKETT	B&G	1.25	3.50	545	\$3,815
5EWC1.55T	EWC515532230103	COIL	217	189	164	86.0%	BECKETT	B&G	1.55	3.80	630	\$5,067
3EWC0.80	EWC308051240103	LESS	112	98	85	86.0%	RIELLO	TACO ECM	0.80	3.05	470	\$3,253
4EWC1.00	EWC410051240103	LESS	140	122	106	86.2%	RIELLO	TACO ECM	1.00	3.25	545	\$3,426
4EWC1.25	EWC412551240103	LESS	175	152	132	86.0%	RIELLO	TACO ECM	1.25	3.50	545	\$3,426
5EWC1.55	EWC515551240103	LESS	217	189	164	86.0%	RIELLO	TACO ECM	1.55	3.80	630	\$4,682
3EWC0.80T	EWC308052240103	COIL	112	98	85	86.0%	RIELLO	TACO ECM	0.80	3.05	470	\$3,788
4EWC1.00T	EWC410052240103	COIL	140	122	106	86.2%	RIELLO	TACO ECM	1.00	3.25	545	\$3,962
4EWC1.25T	EWC412552240103	COIL	175	152	132	86.0%	RIELLO	TACO ECM	1.25	3.50	545	\$3,962
5EWC1.55T	EWC515552240103	COIL	217	189	164	86.0%	RIELLO	TACO ECM	1.55	3.80	630	\$5,584
3EWC0.80	EWC308071240103	LESS	112	98	85	86.0%	CARLIN	TACO ECM	0.80	3.05	470	\$3,102
4EWC1.00	EWC410071240103	LESS	140	122	106	86.2%	CARLIN	TACO ECM	1.00	3.25	545	\$3,275
4EWC1.25	EWC412571240103	LESS	175	152	132	86.0%	CARLIN	TACO ECM	1.25	3.50	545	\$3,275
5EWC1.55	EWC515571240103	LESS	217	189	164	86.0%	CARLIN	TACO ECM	1.55	3.80	630	\$4,532

EMPIRE EWC - Cast Iron Chimney Vent Oil Boiler - Continued

3EWC0.80T	EWC308072240103	COIL	112	98	85	86.0%	CARLIN	TACO ECM	0.80	3.05	470	\$3,643
4EWC1.00T	EWC410072240103	COIL	140	122	106	86.2%	CARLIN	TACO ECM	1.00	3.25	545	\$3,815
4EWC1.25T	EWC412572240103	COIL	175	152	132	86.0%	CARLIN	TACO ECM	1.25	3.50	545	\$3,815
5EWC1.55T	EWC515572240103	COIL	217	189	164	86.0%	CARLIN	TACO ECM	1.55	3.80	630	\$5,067
3EWC0.80	EWC308021200103	LESS	112	98	85	86.0%	LESS	LESS	0.80	N/A	470	\$2,317
4EWC1.25	EWC412521200103	LESS	175	152	132	86.0%	LESS	LESS	1.25	N/A	545	\$2,490
5EWC1.55	EWC515521200103	LESS	217	189	164	86.0%	LESS	LESS	1.55	N/A	630	\$3,703
3EWC0.80T	EWC308022200103	COIL	112	98	85	86.0%	LESS	LESS	0.80	3.05	470	\$2,858
4EWC1.25T	EWC412522200103	COIL	175	152	132	86.0%	LESS	LESS	1.25	3.50	545	\$3,030
5EWC1.55T	EWC515522200103	COIL	217	189	164	86.0%	LESS	LESS	1.55	3.80	630	\$4,238
3EWC0.80	EWC308021240103	LESS	112	98	85	86.0%	LESS	TACO ECM	0.80	N/A	470	\$2,393
4EWC1.25	EWC412521240103	LESS	175	152	132	86.0%	LESS	TACO ECM	1.25	N/A	545	\$2,566
5EWC1.55	EWC515521240103	LESS	217	189	164	86.0%	LESS	TACO ECM	1.55	N/A	630	\$3,823
3EWC0.80T	EWC308022240103	COIL	112	98	85	86.0%	LESS	TACO ECM	0.80	3.05	470	\$2,934
4EWC1.25T	EWC412522240103	COIL	175	152	132	86.0%	LESS	TACO ECM	1.25	3.50	545	\$3,106
5EWC1.55T	EWC515522240103	COIL	217	189	164	86.0%	LESS	TACO ECM	1.55	3.80	630	\$4,358
3EWC0.80	EWC308021220103	LESS	112	98	85	86.0%	LESS	GRUNDFOS	0.80	N/A	470	\$2,393
4EWC1.25	EWC412521220103	LESS	175	152	132	86.0%	LESS	GRUNDFOS	1.25	N/A	545	\$2,566
5EWC1.55	EWC515521220103	LESS	217	189	164	86.0%	LESS	GRUNDFOS	1.55	N/A	630	\$3,823
3EWC0.80T	EWC308022220103	COIL	112	98	85	86.0%	LESS	GRUNDFOS	0.80	3.05	470	\$2,934
4EWC1.25T	EWC412522220103	COIL	175	152	132	86.0%	LESS	GRUNDFOS	1.25	3.50	545	\$3,106
5EWC1.55T	EWC515522220103	COIL	217	189	164	86.0%	LESS	GRUNDFOS	1.55	3.80	630	\$4,358

EMPIRE EWC - BURNERS

Model	Item Number	Description	Trade Price
EWC	550003929	RIELLO BURNER (3/4/5 SECTION)^	\$727
EWC	550003928	CARLIN EZ-1 BURNER (3/4/5 SECTION)^	\$709
EWC	550003927	BECKETT EWC AFG (3 SECTION)	\$709
EWC	550003960	BECKETT EWC AFG (4/5 SECTION)^	\$709

^BURNER-IN-BOX Requires Additional Purchase of Rerate Kit from List Below

EMPIRE EWC (Use Parts Multiplier for All of the Following)

Model	Item Number	Description	Trade Price
EWC	550004243	4 SECTION BECKETT BURNER RE-RATE KIT, 1.25 TO 1.00	\$68
EWC	550004244	4 SECTION BECKETT BURNER RE-RATE KIT, 1.00 TO 1.25	\$68
EWC	550004245	4 SECTION RIELLO, CARLIN, BURNER RE-RATE KIT, 1.25 TO 1.00	\$68
EWC	550004246	4 SECTION RIELLO BURNER RE-RATE KIT, 1.00 TO 1.25	\$68
EWC	550004247	4 SECTION CARLIN BURNER RE-RATE KIT, 1.00 TO 1.25	\$68
EWC	14624002	FILL-TROL #110 FOR WATER BOILERS 150 MBH OR LESS	\$337
EWC	14624003	FILL-TROL #111 FOR WATER BOILERS OVER 150 MBH	\$467

**This page is intentionally left blank,
products continue on the following page.**

SBO Cast Iron Steam Oil Boilers

- MBH Input 119 - 210 (CH)
- Up to 85.6% AFUE
- Dependable Cast Iron Heat Exchanger
- Cast Iron Swing out Burner Door and large flueways allow for easy cleaning and servicing
- Honeywell Pressure Control, Boiler Water Level Gauge Glass, and Steam Pressure Gauge
- Electronic Low Water Cutoff (LWCO)
- Atmospheric Chimney Vent Boiler

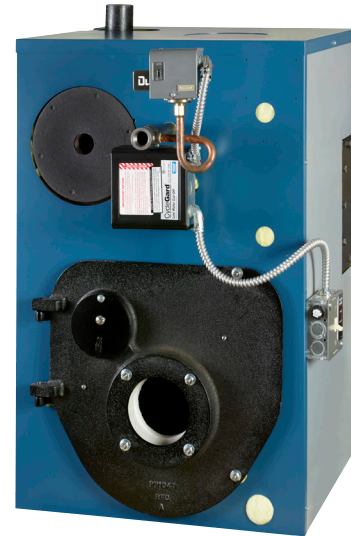

General Information (See IOM for Complete Instructions)				
Model	SBO-3085	SBO-3105	SBO-4125	SBO-4150
Return/Supply Tappings	1 1/4" Return NPT, 2" Supply NPT			
Oil	3/8" O.D. Copper (runs 50' or less, 1/2" O.D. Copper (runs over 50')			
Electrical	120 Volts AC, 60 hertz, 1 phase, less than 12 amps (15 amp circuit recommended)			
Water Content (Gallons)	12	12	14.87	14.87
Dimensions	A-Height	35"	35"	35"
	B-Width	22 1/8"	22 1/8"	22 1/8"
	C-Depth	15 3/4"	15 3/4"	19 3/4"

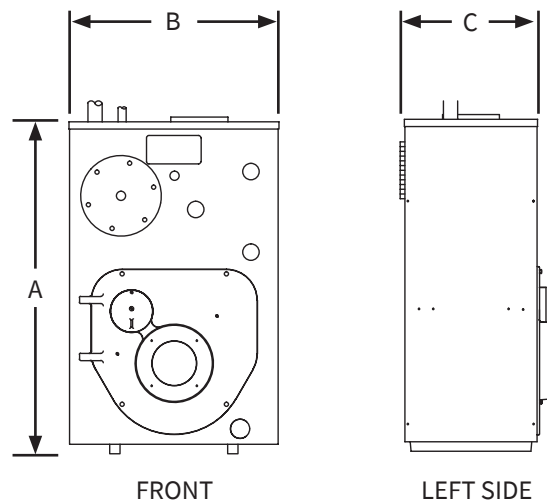

SBO - Cast Iron Steam Oil Boiler Less Burner

Model	Item Number	Type	Input MBH	Htg. Cap. MBH	AHRI Net MBH	AHRI Net Sq. Ft.	AFUE	Burner	Firing Rate GPH	Shp. Wgt. lbs	Trade Price
SBO-3105	SBO310521700103	LESS	147	127	95	396	85.0%	LESS	1.05	538	\$3,072
SBO-4150	SBO415021700103	LESS	210	180	135	563	85.0%	LESS	1.50	650	\$3,610

SBO (Use Equipment Multiplier for All of the Following)

Model	Item Number	Description	Trade Price
SBO	550004158D	TANKLESS COIL KIT WITH CONTROL	\$425
SBO-3105	550004153D	SBO-3105 BECKETT BURNER IN A BOX KIT	\$700
SBO-4150	550004154D	SBO-4150 BECKETT BURNER IN A BOX KIT	\$700

Please Note: Oil Fired Steam Boilers are sold less burner. Please add burner in a box kit to your order.

Tankless Coil Kits are sold separately.

SBO (Use Parts Multiplier for All of the Following)

Model	Item Number	Description	Trade Price
SBO	550004155	3085/3105 BECKETT RERATE KIT	\$132
SBO	550004156	4125/4150 BECKETT RERATE KIT	\$132

H2O GL Single Coil Glass Lined Indirect Water Heaters

- 31 - 106 Gallon Capacities
- Easy to Install
- Low Pressure Drop
- Magnesium Anode Rod Corrosion Protection
- Enameled Coated Steel Tank and Coil
- Minimal Standby Losses
- Flexible Scratch Resistant Jacket
- Aquastat Sensor Well
- Temperature Pressure Relief Valve



(H2O40GL Model Shown)

General Information (See IOM for Complete Instructions)					
Maximum Working Pressure: 150 psi for all Capacities					
Model	Piping Connections NPT		Dimensions		
	Domestic Water In/Out	Boiler Water In/Out	Diameter	Height	Weight
H2O 30 GL	1"	1"	24"	33"	119 lbs
H2O 40 GL	1"	1"	24"	45"	180 lbs
H2O 50 GL	1"	1"	24"	51"	200 lbs
H2O 80 GL	1"	1"	30"	48"	243 lbs
H2O 105 GL	1"	1"	30"	62"	393 lbs

H2O GL - Single Coil Glass Lined Indirect Water Heaters								
Model	Item Number	Storage Capacity gal	Type	Max. First Hour Rating gal/hr @	Continuous Rating gal/hr @	Boiler Output Req. BTU/hr	Shp. Wgt. lbs	Trade Price
H2O 30 GL	H2OIG30DK	31	GLASS LINED	155	124	100,000	119	\$1,128
H2O 40 GL	H2OIG40DK	42	GLASS LINED	256	220	120,000	180	\$1,160
H2O 50 GL	H2OIG50DK	53	GLASS LINED	310	268	140,000	200	\$1,322
H2O 80 GL	H2OIG80DK	79	GLASS LINED	346	281	180,000	243	\$1,833
H2O 105 GL	H2OIG105DK	106	GLASS LINED	440	345	220,000	393	\$2,869
H2O GL (Use Parts Multiplier for All of the Following)								
Model	Item Number	Description						Trade Price
30-105 GAL.	240010926	T & P VALVE 3/4, 100XL-8						\$49
30-105 GAL.	AQ-020.01	AQUASTAT WELL						\$34
30-105 GAL.	240009521	AQUASTAT L4080B1352						\$137
30-50 GAL.	240012211	PLASTIC TOP CAP						\$27
80-105 GAL.	240012239	PLASTIC TOP CAP						\$38
40-105 GAL.	240012212	PLASTIC FRONT CAP						\$8
30 GAL.	550003640	ANODE KIT MAGNESIUM (INCLUDES ANODE, GASKET & BUSHING)						\$36
40-50 GAL.	550003505	ANODE KIT MAGNESIUM (INCLUDES ANODE, GASKET & BUSHING)						\$36
80-105 GAL.	550003527	ANODE KIT MAGNESIUM (INCLUDES ANODE, GASKET & BUSHING)						\$69
30 GAL.	550003693	ANODE KIT ALUMINUM (INCLUDES ANODE, GASKET & BUSHING)						\$35
40-50 GAL.	550003694	ANODE KIT ALUMINUM (INCLUDES ANODE, GASKET & BUSHING)						\$36
80-105 GAL.	550003695	ANODE KIT ALUMINUM (INCLUDES ANODE, GASKET & BUSHING)						\$69
30-50 GAL.	240012250	FLANGE CAP						\$38
80-105 GAL.	240012251	FLANGE CAP						\$14
30-50 GAL.	240012210	FLANGE GASKET						\$2
80-105 GAL.	240012238	FLANGE GASKET						\$4
40-50 GAL.	550003510	HARDWARE KIT (INCLUDES BOLTS & NUTS FOR FLANGE CAP)						\$4
80-105 GAL.	550003525	HARDWARE KIT (INCLUDES BOLTS & NUTS FOR FLANGE CAP)						\$4
H2O 30 GL	240012474	OUTSIDE TANK COVER						\$101
H2O 40 GL	240012329	OUTSIDE TANK COVER						\$102
H2O 50 GL	240012330	OUTSIDE TANK COVER						\$109
H2O 80 GL	240012331	OUTSIDE TANK COVER						\$119
H2O 105 GL	240012332	OUTSIDE TANK COVER						\$133
30-50 GAL.	240012483	TEMPERATURE GAUGE						\$15
80-105 GAL.	240012484	TEMPERATURE GAUGE						\$22

H2O SC Single Coil Stainless Steel Indirect Water Heaters

- 30 - 115 Gallon Capacities
- 316L Stainless Steel Construction
- Top Connections (For Easy Install)
- Stainless Steel Dip Tube
- Thermoplastic Jacket
- Low Pressure Drop
- T & P Valve, Stainless Steel Aquastat Well and Drain Valve
- 2.25" EPS Insulation
- Large Diameter, Smooth Coil Heat Exchangers - Prevent Buildup
- Honeywell L4080B Aquastat



H2O

I

Indirect

30

Capacity:
 30=30 gals
 40=40 gals
 50=50 gals
 60=60 gals
 80=80 gals
 85=87 gals
 115=115 gals

L

Type:
 L=Lowboy
 HO=High Output
 HOC=High Output
 Commercial
 XHO=Extra High
 Output

DK

DK=Dunkirk

General Information (See IOM for Complete Instructions)					
Maximum Working Pressure: 150 psi for all Capacities					
Model	Piping Connections NPT		Dimensions		
	Domestic Water In/Out	Boiler Water In/Out	Diameter	Height	Weight
H2OI30DK	3/4"	1"	23 1/2"	34"	85 lbs
H2OI40DK	3/4"	1"	23 1/2"	44"	100 lbs
H2OI40LDK	3/4"	1"	28"	36"	100 lbs
H2OI50DK	3/4"	1"	23 1/2"	54"	110 lbs
H2OI60DK	3/4"	1"	23 1/2"	62"	125 lbs
H2OI60LDK	3/4"	1"	28"	46"	120 lbs
H2OI80DK	1"	1"	28"	56"	140 lbs
H2OI115DK	1"	1"	28"	74"	175 lbs
High Output Units					
H2OI60HODK	1"	1"	23 1/2"	62"	145 lbs
H2OI80HODK	1"	1"	28"	56"	155 lbs
H2OI80HOC DK	1 1/2"	1 1/4"	28"	56"	155 lbs
H2OI115HODK	1"	1"	28"	74"	190 lbs
H2OI115HOC DK	1 1/2"	1 1/4"	28"	74"	190 lbs
Extra High Output Units 85XHO and 115XHO					
H2OI85XHOC DK	1 1/2"	1 1/2"	28"	64"	215 lbs
H2OI115XHOC DK	1 1/2"	1 1/2"	28"	74"	240 lbs

H2O SC - Single Coil Stainless Steel Indirect Water Heaters							
Item Number	Storage Capacity gal	Type	Max. First Hour Rating gal/hr @ 140° F/115° F		Boiler Output Req. BTU/hr	Shp. Wgt. lbs	Trade Price
H2OI30DK	30	STANDARD	202	269	131,250	85	\$1,540
H2OI40DK	40	STANDARD	221	292	138,670	100	\$1,584
H2OI40LDK	42	LOWBOY	212	251	132,000	100	\$1,688
H2OI50DK	50	STANDARD	223	291	133,280	110	\$1,913
H2OI60DK	60	STANDARD	262	342	155,700	125	\$2,289
H2OI60LDK	60	LOWBOY	239	310	138,570	120	\$2,353
H2OI80DK	80	STANDARD	271	248	149,390	140	\$2,535
H2OI115DK	115	STANDARD	324	409	165,750	175	\$3,764
H2OI60HODK	60	HIGH OUTPUT	406	541	263,600	145	\$2,468
H2OI80HODK	80	HIGH OUTPUT	418	551	259,640	155	\$3,429
H2OI80HOC DK	80	HIGH OUTPUT COMMERCIAL	442	584	227,070	155	\$3,702
H2OI115HODK	115	HIGH OUTPUT	467	607	273,100	190	\$4,639
H2OI115HOC DK	115	HIGH OUTPUT COMMERCIAL	479	623	281,300	190	\$4,910
H2OI85XHOC DK	87	EXTRA HIGH OUTPUT	738	992	495,000	215	\$4,608
H2OI115XHOC DK	115	EXTRA HIGH OUTPUT	763	1017	495,000	240	\$5,469

H2O DC Single & Dual Coil Stainless Steel Solar Water Heaters

- 60 - 115 Gallon Capacities
- 316L Stainless Steel Construction
- Top Connections (For Easy Install)
- Stainless Steel Dip Tube
- Thermoplastic Jacket
- Low Pressure Drop
- T & P Valve, Stainless Steel Aquastat Well and Drain Valve
- 2.25" EPS Insulation
- Large Diameter, Smooth Coil Heat Exchangers - Prevent Buildup
- Honeywell L4080B Aquastat



H2O

I

Indirect

60

Capacity:
 60=60 gals
 80=80 gals
 115=115 gals

D

D=Dual Coil

E

E=Electric Backup
 (3500 Watts)

DK

DK=Dunkirk

General Information (See IOM for Complete Instructions)				
Maximum Working Pressure: 150 psi for all Capacities				
Model	Piping Connections NPT	Dimensions		
		Diameter	Height	Weight
H2O160EDK	1"	23"	62"	135 lbs
H2O180EDK	1"	28"	56"	145 lbs
H2O115EDK	1"	28"	74"	180 lbs
H2O160DDK	1"	23"	62"	165 lbs
H2O180DDK	1"	28"	56"	175 lbs
H2O115DDK	1"	28"	74"	205 lbs
H2O160DEDK	1"	23"	62"	175 lbs
H2O180DEDK	1"	28"	56"	185 lbs
H2O115DEDK	1"	28"	74"	215 lbs

H2O DC - Single & Dual Coil Stainless Steel Solar Water Heaters						
Item Number	Storage Capacity gal	Type	Recovery Rate gal/hr		Ship Wgt. lbs	Trade Price
			Top Coil	Bottom Coil		
H2OI60EDK	60	ELECTRIC BACK-UP	N/A	214	135	\$2,937
H2OI80EDK	80	ELECTRIC BACK-UP	N/A	214	145	\$3,288
H2OI115EDK	115	ELECTRIC BACK-UP	N/A	214	180	\$4,444
H2OI60DDK	60	INDIRECT	185	214	165	\$3,035
H2OI80DDK	80	INDIRECT	180	214	175	\$3,456
H2OI115DDK	115	INDIRECT	190	214	205	\$4,425
H2OI60DEDK	60	ELECTRIC BACK-UP	185	214	175	\$4,102
H2OI80DEDK	80	ELECTRIC BACK-UP	180	214	185	\$4,632
H2OI115DEDK	115	ELECTRIC BACK-UP	190	214	215	\$5,811

H2O BT Stainless Steel Buffer Tanks, w/ and w/o Coil

- 22 - 115 Gallon Capacities
- 316L Stainless Steel Construction
- Top Connections (For Easy Installation)
- Thermoplastic Jacket
- Low Pressure Drop
- T & P Valve, Stainless Steel Aquastat Well and Drain Valve
- 2.25" EPS Insulation



H2O

BT
 BT=Buffer Tank

40
 Capacity:
 22=22 gals
 40=40 gals
 60=60 gals
 80=80 gals

114
 Connection:
 114=1 1/4" NPT
 112=1 1/2" NPT
 2=2" NPT

WC
 WC=With Coil

DK
 DK=Dunkirk

General Information (See IOM for Complete Instructions)				
Maximum Working Pressure: 150 psi for all Capacities				
Model	Piping Connections NPT	Dimensions		
		Diameter	Height	Weight
H2OBT22114DK	1 1/4"	22 1/2"	24 1/2"	35 lbs
H2OBT40114DK	1 1/4"	22 1/2"	42"	87 lbs
H2OBT40112DK	1 1/2"	22 1/2"	42"	87 lbs
H2OBT402DK	2"	22 1/2"	42"	87 lbs
H2OBT60114DK	1 1/4"	26 1/2"	44"	115 lbs
H2OBT60112DK	1 1/2"	26 1/2"	44"	115 lbs
H2OBT602DK	2"	26 1/2"	44"	115 lbs
H2OBT80114DK	1 1/4"	26 1/2"	54"	125 lbs
H2OBT80112DK	1 1/2"	26 1/2"	54"	125 lbs
H2OBT802DK	2"	26 1/2"	54"	125 lbs
H2OBT115114DK	1 1/4"	26 1/2"	72"	160 lbs
H2OBT115112DK	1 1/2"	26 1/2"	72"	160 lbs
H2OBT1152DK	2"	26 1/2"	72"	160 lbs
H2OBT40114WCDK	1 1/4"	22 1/2"	42"	97 lbs
H2OBT40112WCDK	1 1/2"	22 1/2"	42"	97 lbs
H2OBT402WCDK	2"	22 1/2"	42"	97 lbs
H2OBT60114WCDK	1 1/4"	26 1/2"	44"	125 lbs
H2OBT60112WCDK	1 1/2"	26 1/2"	44"	125 lbs
H2OBT602WCDK	2"	26 1/2"	44"	125 lbs
H2OBT80114WCDK	1 1/4"	26 1/2"	54"	135 lbs
H2OBT80112WCDK	1 1/2"	26 1/2"	54"	135 lbs
H2OBT802WCDK	2"	26 1/2"	54"	135 lbs
H2OBT115114WCDK	1 1/4"	26 1/2"	72"	170 lbs
H2OBT115112WCDK	1 1/2"	26 1/2"	72"	170 lbs
H2OBT1152WCDK	2"	26 1/2"	72"	170 lbs

H2O BT - Stainless Steel Buffer Tanks (With & Without Coil)				
Item Number	Storage Capacity gal	Type	Shp. Wgt. lbs	Trade Price
H2OBT22114DK	22	HYDRONIC BUFFER TANK	35	\$1,371
H2OBT40114DK	40	HYDRONIC BUFFER TANK	87	\$2,399
H2OBT40112DK	40	HYDRONIC BUFFER TANK	87	\$2,399
H2OBT402DK	40	HYDRONIC BUFFER TANK	87	\$2,399
H2OBT60114DK	60	HYDRONIC BUFFER TANK	115	\$2,857
H2OBT60112DK	60	HYDRONIC BUFFER TANK	115	\$2,857
H2OBT602DK	60	HYDRONIC BUFFER TANK	115	\$2,857
H2OBT80114DK	80	HYDRONIC BUFFER TANK	125	\$3,151
H2OBT80112DK	80	HYDRONIC BUFFER TANK	125	\$3,151
H2OBT802DK	80	HYDRONIC BUFFER TANK	125	\$3,151
H2OBT115114DK	115	HYDRONIC BUFFER TANK	160	\$3,924
H2OBT115112DK	115	HYDRONIC BUFFER TANK	160	\$3,924
H2OBT1152DK	115	HYDRONIC BUFFER TANK	160	\$3,924
H2OBT40114WCDK	40	HYDRONIC BUFFER TANKS (WITH COIL)	97	\$3,075
H2OBT40112WCDK	40	HYDRONIC BUFFER TANKS (WITH COIL)	97	\$3,075
H2OBT402WCDK	40	HYDRONIC BUFFER TANKS (WITH COIL)	97	\$3,075
H2OBT60114WCDK	60	HYDRONIC BUFFER TANKS (WITH COIL)	125	\$3,268
H2OBT60112WCDK	60	HYDRONIC BUFFER TANKS (WITH COIL)	125	\$3,268
H2OBT602WCDK	60	HYDRONIC BUFFER TANKS (WITH COIL)	125	\$3,268
H2OBT80114WCDK	80	HYDRONIC BUFFER TANKS (WITH COIL)	135	\$3,899
H2OBT80112WCDK	80	HYDRONIC BUFFER TANKS (WITH COIL)	135	\$3,899
H2OBT802WCDK	80	HYDRONIC BUFFER TANKS (WITH COIL)	135	\$3,899
H2OBT115114WCDK	115	HYDRONIC BUFFER TANKS (WITH COIL)	170	\$4,746
H2OBT115112WCDK	115	HYDRONIC BUFFER TANKS (WITH COIL)	170	\$4,746
H2OBT1152WCDK	115	HYDRONIC BUFFER TANKS (WITH COIL)	170	\$4,746

H2O ST Stainless Steel Storage Tanks

- 30 - 115 Gallon Capacities
- 316L Stainless Steel Construction
- Top Connections (For Easy Installation)
- Stainless Steel Dip Tube -Thermoplastic Jacket
- Low Pressure Drop
- T & P Valve, Stainless Steel Aquastat Well and Drain Valve
- 2.25” EPS Insulation
- Honeywell L4080B



H2O

ST

ST=Storage

30

Capacity:
 30=30 gals
 40=40 gals
 60=60 gals
 80=80 gals
 115=115 gals

L

Type:
 L=Lowboy
 C=Commercial

DK

DK=Dunkirk

General Information (See IOM for Complete Instructions)					
Maximum Working Pressure: 150 psi for all Capacities					
Model	Piping Connections NPT		Dimensions		
	Return/Supply	Heat Source Pressure	Diameter	Height	Weight
H2OST30DK	1”	1”	23 1/2”	34”	75 lbs
H2OST40DK	1”	1”	23 1/2”	44”	90 lbs
H2OST60DK	1”	1”	23 1/2”	62”	115 lbs
H2OST60LDK	1”	1”	23 1/2”	46”	110 lbs
H2OST80DK	1”	1”	28”	56”	140 lbs
H2OST115DK	1”	1”	28”	74”	175 lbs
H2OST80CDK	1 1/2”	1”	28”	56”	140 lbs
H2OST115CDK	1 1/2”	1”	28”	74”	175 lbs

H2O ST - Stainless Steel Storage Tanks (No Coil)				
Item Number	Storage Capacity gal	Type	Shp. Wgt. lbs	Trade Price
H2OST30DK	30	STANDARD STORAGE TANK	75	\$1,368
H2OST40DK	40	STANDARD STORAGE TANK	90	\$1,414
H2OST60DK	60	STANDARD STORAGE TANK	115	\$2,061
H2OST60LDK	60	LOWBOY STORAGE TANK	110	\$2,127
H2OST80DK	80	STANDARD STORAGE TANK	140	\$2,341
H2OST80CDK	80	COMMERCIAL STORAGE TANK	175	\$3,372
H2OST115DK	115	STANDARD STORAGE TANK	140	\$2,576
H2OST115CDK	115	COMMERCIAL STORAGE TANK	175	\$3,608

TERMS & CONDITIONS OF SALE - GENERAL TERMS

PRICES & SPECIFICATIONS: All pricing and specifications subject to change without notice. The prices herein supersede all prior quotations.

ORDERS: Orders will be accepted based on prices in effect at the time the order is received. No order or contract will become an obligation on our part until accepted by the General Sales Department. ECR International shall not be liable for any delay or failure in the delivery or shipment of goods due to any cause or causes beyond its control.

TAXES: Add to the prices and terms quoted any manufacturers' or sales tax payable on the transaction under any effective statute.

SHIPMENTS

TRUCKLOADS: \$50,000 Net Order Value - Freight Prepaid. Indirect Water Heaters and Commercial Boiler lines can be added to any residential order for freight purposes. Authorized Distributors can combine Argo, Airco, Dunkirk, EMI, Olsen, Pennco, Utica Boilers and Utica Heating on one purchase order to earn free freight.

Stop off charges of \$150 will apply to stop off locations within 100 miles of the final destination. Please call for pricing for stop off special handling for a location further than 100 miles or for special handling pricing for services such as lift gate, unloading assistance, etc.

LESS THAN TRUCKLOAD SHIPMENT: F.O.B. ECR INTERNATIONAL - FACTORY OR WAREHOUSE

See Shipping and Delivery Policy for full details.

SALES ORDER INFORMATION CHECK LIST

The following information must be included on equipment or parts orders to insure proper shipment & invoicing:

- | | |
|--|--|
| 1) Purchase Order Number | 7) Pricing |
| 2) Bill to Address | 8) Product Description (Model, Size, etc.) |
| 3) Ship to Address | 9) Fuel Type (Oil, Natural Gas, Propane) |
| 4) Method of Shipment (trailer load, UPS) | 10) Electrical (Operating Voltage, Cycles, Phases, etc.) |
| 5) Requested Ship Date | 11) Non-Standard Equipment (Indicate "Optional" when substituted for standard equipment at extra cost listed. Indicate added to standard equipment.) |
| 6) Special Instructions ("Carrier to call...") | 12) Kits or Parts (Orders for kits or parts must indicate equipment size and series.) |

Send orders to:

E-mail: ecrorderentry@ecrinternational.com

Fax: (315) 724-9319

Please note the following Remit to Address:

ECR International, Inc.

P.O. Box 8000 Department 039

Buffalo, NY 14267

SHIPPING AND DELIVERY POLICY

Order type/value*	Freight Charge*
All UPS, Fed Ex, DHL etc. shipments	Actual Freight Cost Apply
\$0 - \$5,000	Actual Freight Cost Apply
\$5,001 - \$15,000	\$300
\$15,001 - \$49,999	\$250
\$50,000+**	FFA

*The above freight terms apply to single purchase orders or combined purchases orders from one company with one stop totaling the above reference tiers. Additional stops will incur additional charges. Pooling from multiple companies is not allowed under this freight program.

**Orders of \$50K or more from one company with multiple stops will incur a \$150 stop-off charge per stop after the first. Each stop-off location must be within 100 miles or additional charges will apply.

Because of the nature of packaging and shipping constraints EMI, Enviroair and Retroaire do not qualify for this program unless prior approval is obtained.

Except for FFA qualifying orders, the above US shipping rates apply to shipments east of the Mississippi River. If shipments are outside of that area actual freight rates will apply.

These rates apply to destinations where no special delivery requirements are needed. Additional charges will apply when special handling and delivery is incurred. Pre-shipment notification of any special shipping or handling provisions is required. Unless otherwise noted all products will be shipped FOB Shipping Point and transfer of ownership and responsibility is assumed by the customer for all loss or damage. ECR International will not be held liable for any damage, loss or costs which occur due to shipping delay. ECR retains the right to change or alter this program without notice and without penalty

As a reminder, orders of boilers, furnaces, air-conditioning and controls can be combined to achieve freight tiers.

If you have any questions, please contact your ECR representative or ECR Regional Sales Manager.

U.S. DISTRIBUTOR - RETURN MATERIAL POLICY (RMA)

Prior Approval Required - All returns for exchange, credit, repair service or warranty claim must be approved by ECR International and require an RMA number prior to return of the material. A request must be completed via the online web portal. Please log on to www.ecrcustomerportal.com to complete your request for return. If you do not already have access to the customer web portal, please contact ECR International Customer Service at 1-800-325-5479 to be set-up.

Eligibility – An RMA Request must be received within 60 days from the date of invoice for returns of New & Unused product in original packaging. A restocking fee of 15% will be charged for all new and unused returns that are approved for return. Special Order Products (items not offered as standard in ECR International trade price book) are not eligible for return as new and unused product. Request for Warranty Returns must be made within the period covered by the warranty and must fall under the terms and conditions specified in the warranty.

Repair Service - Request for repair or rework of product damaged by customer is classified as Repair Service. Repair Service is billed at \$75.00 per hour for labor and net price for parts used in repair/rework. ECR International's Return Material (RM) department will evaluate the items returned for repair service. The customer will receive an estimate for the dollar amount, determined by ECR International's RM department, required to complete the repairs requested. A Purchase Order (PO) from the customer for that amount will be required before any work is performed.

RMA Expiration Parts - Once the RMA number is issued, the product must be returned within 60 days of the RMA date, or the RMA will be canceled. Products approved for return that are received after 60 days from the RMA date will not be accepted.

Shipping & Packaging - All returns must have a valid RMA number clearly displayed on the exterior of the package or the package will not be accepted. All returns of new and unused product must be in the original packaging. All returns must be shipped prepaid by the customer unless otherwise directed by ECR as indicated on the RMA Verification. Ship all approved return material to the facility indicated on the approved RMA Request by the date indicated.

Replacement Product - If replacement product is desired it must be indicated on the RMA Request. A PO# is required for the replacement shipment and must be indicated on the RMA Request. All replacement products will be invoiced at the time of shipment. ECR will pay the ground freight for all warranty replacements.

Application of Credit - Credit for returned product will be applied to the customer's account (less restocking fees for New and Unused returns) only after confirmation of receipt by ECR and inspection of the product. Issuance of a credit for a partial return of product does not relieve the customer from the obligation to remit payment for the merchandise not returned in accordance with the payment terms referenced on the customer's invoice(s). Customer will have the option to have any product that is denied for credit returned at their expense.

Returning Installed Finished Goods (Complete boilers, furnaces, A/C units etc.)

- Equipment that is already installed should be repaired not replaced. Exceptions: leaking cast iron boilers in their first year or leaking water tanks. Leaking drain valves on water tanks are replaceable, make sure the leak is not on the valve. Tanks returned with the only leak being on the valve will be denied.
- Cast iron blocks (not complete boilers) older than one year and Indirect tanks that are leaking do not require prior approval. Simply type "Leaking" into the Authorization field and it will be accepted. Complete Cast iron boilers within their first year will still require prior authorization for full boiler replacement.
- Water leaks on copper and condensing boilers are repairable and will require prior authorization for any reason for removal.
- To guarantee credit, if a situation arises where equipment does need to be replaced, **prior authorization** from ECR is required. This will ensure that ECR has visibility to the problem and has had an opportunity to correct it prior to removal. *All equipment considered for removal should first be brought to the attention of Technical Support at 1-800-253-7900.*
- If approved, an authorization number will be given that will need to be entered in the RMA on the Customer Portal.
- For equipment that is removed from service without prior authorization by ECR, contact Customer Service. They will evaluate the circumstance and can issue a conditional RMA. The equipment will be tested in our lab to determine if removal was warranted and if credit will be given.

RMA Expiration Equipment - Once the RMA number is issued, the product must be returned within 30 days of the RMA date, or the RMA will be canceled. Products approved for return that are received after 30 days from the RMA date will not be accepted.

This page is intentionally left blank.



2201 Dwyer Avenue, Utica, NY 13501
Tel. 800 325 5479
www.ecrinternational.com

All specifications subject to change without notice.
©2021 ECR International, Inc.
PN 240005064 REV. O [05/15/2021]