



US Trade Price Book - 2022

Effective 9/23/22



Innovative. Efficient. Dependable. Dunkirk.



www.dunkirk.com



Manufactured by:
ECR International Inc.
2201 Dwyer Avenue, Utica, NY 13501
Tel. 800 325 5479
www.ecrinternational.com
PN 240005064 REV. U [12/20/2022]

CUSTOMER SUPPORT TEAM

CUSTOMER SERVICE:

Phone: (800) 325-5479 option #2
Fax: (315) 724-9319
Email Purchase Orders: ecrorderentry@ecrinternational.com
Email Inquiries: customerservice@ecrinternational.com

TECHNICAL SUPPORT:

Phone: (800) 253-7900
Fax: (866) 432-7329
Email: technical.support@ecrinternational.com

MARKETING SUPPORT:

Phone: (800) 325-5479
Fax: (315) 733-1759
E-mail: marketing@ecrinternational.com

WWW.ECRCUSTOMERPORTAL.COM

Your On-line Access to:

- Order Status
- Invoices
- Statements
- RMA
- Serial Number Look-Up
- Literature

Table of Contents

<u>Condensing Natural / LP Gas Boilers with [AI] Control (Gas Adaptive)</u>		<u>4-7</u>
DCC/DCB	Stainless Steel Wall Hung Combi & Heating Boilers (75-205 MBH)	4
DCCF/DCBF	Stainless Steel Floor Standing Combi & Heating Boilers (75-205 MBH)	6
<u>Condensing Natural / LP Gas Boilers</u>		<u>8-11</u>
DMG 240	Stainless Steel Wall Hung Heating Boilers (241 MBH)	10
DMG 380	Stainless Steel Floor Standing Heating Boilers (379 MBH)	12
<u>Controls & Venting</u>		<u>12-15</u>
MBC	Multiple Boiler Control (MBC)	12
VENTING	Coaxial, Twin Pipe & CPVC Venting for Condensing Boilers	13
<u>Electric Boilers</u>		<u>16-17</u>
AT SERIES	Electric Wall Hung Heating Boilers	16
<u>Natural / LP Gas Boilers</u>		<u>18-35</u>
XEB	Cast Iron Induced Draft Chimney/Side Wall Vented (42.5-187.5 MBH)	18
DXL	Cast Iron Chimney Vented Boilers (59-235 MBH)	22
WPSB	Cast Iron Integral Draft Diverter Boilers (75-299 MBH)	26
PSB	Cast Iron Steam Boilers (75-299 MBH)	30
D249	Cast Iron Commercial Steam Boilers (300-1,500 MBH)	32
<u>Oil Boilers</u>		<u>36-45</u>
EXCELSIOR EXB	Cast Iron 3-Pass Boilers (105-252 MBH)	36
DHW MODULE	Domestic Hot Water Module	36
EMPIRE EWC	Cast Iron Chimney Vented Boilers (112-217 MBH)	40
SBO	Cast Iron Steam Boilers (119-210 MBH)	44
<u>Indirect Tanks</u>		<u>46-55</u>
H2O GL	Single Coil Glass Lined Indirect Water Heaters (31-106 GALS)	46
H2O SC	Single Coil Stainless Steel Indirect Water Heaters (30-115 GALS)	48
H2O DC	Single & Dual Coil Stainless Steel Solar Water Heaters (60-115 GALS)	50
H2O BT	Stainless Steel Buffer Tanks (With & Without Coil) (22-115 GALS)	52
H2O ST	Stainless Steel Storage Tanks (No Coil) (30-115 GALS)	54
<u>Terms, Shipping & Delivery Policy, RMA Policy</u>		<u>56-58</u>

DCC/DCB Stainless Steel Wall Hung Combi & Heating Boilers

- MBH Input 75 - 164 (CH) / 115.5 - 205 (DHW)
- Up to 95% AFUE
ENERGY STAR® Certified
- [AI] Control Technology Recognizes Natural or LP Gas
No field conversion kit required.
- 6.9:1 Turndown Modulation Ratio in DHW Mode (115)
7:1 Turndown Modulation Ratio in DHW Mode (150/205)
4.5:1 Turndown Modulation Ratio in CH Mode (75)
5.6:1 Turndown Modulation Ratio in CH Mode (100/115)
5.7:1 Turndown Modulation Ratio in CH Mode (125/150)
5.5:1 Turndown Modulation Ratio in CH Mode (165/205)
- 2.5 gpm DHW Flow Rate @ 70°F Rise (115)
3.5 gpm DHW Flow Rate @ 70°F Rise (150)
5 gpm DHW Flow Rate @ 70°F Rise (205)
- LABOR SAVER™ Primary/Secondary Manifold Included
- Low Water Pressure Switch
- Wall Hung or Floor Stand Kit Available



General Information (See IOM for Complete Instructions)								
Model	DCB-75	DCB-100	DCB-125	DCC-115	DCC-150	DCB-165	DCC-205	
System Supply/Return	G 3/4" Straight Thread					G 1" Straight Thread		
System Supply/Return with Provided Manifold	1 1/4" Copper Sweat					1 1/2" Copper Sweat	1 1/4" Copper Sweat	
Gas Inlet	3/4" NPT					3/4" NPT		
Condensate Drain	13/16" ID Hose					3/4" NPT		
DHW Outlet (125 Optional)	G 1/2" Straight Thread					G 3/4" Straight Thread		
DHW (Cold Water) Inlet	1/2"					3/4"		
Electrical	120 Volts AC, 60 hertz, 1 phase, less than 12 amps (15 amp circuit recommended)							
Water Content (Gallons)	1					1 1/4		
Dimensions	A-Height	30"					30"	
	B-Width	17 3/4"					17 3/4"	
	C-Depth	13 9/16"					21 1/2"	

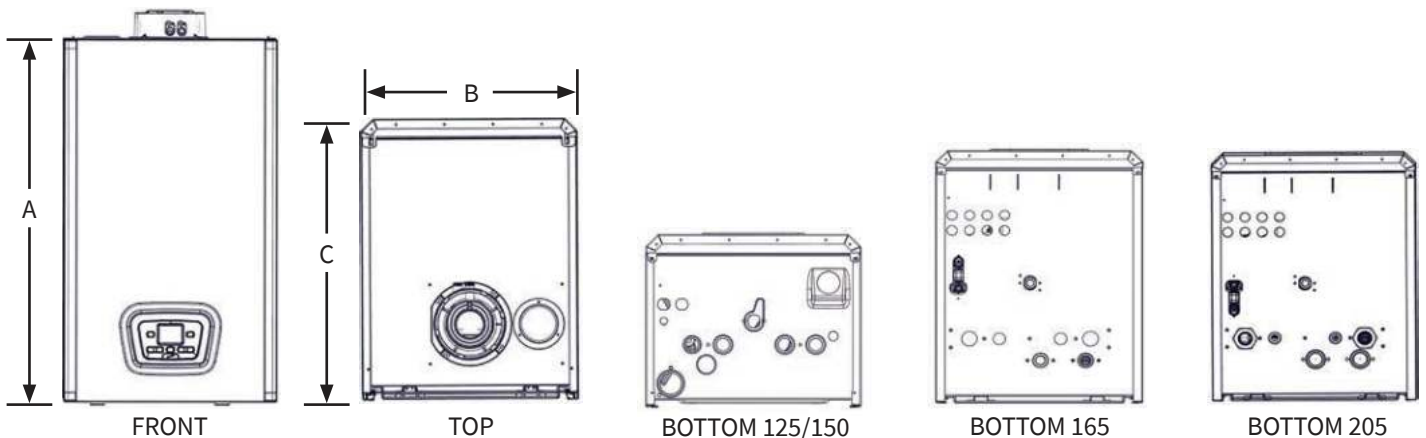

DCC/DCB - Stainless Steel Wall Hung Combi & Heating Boilers

Model	Item Number	Type	Input MBH CH	Input MBH DHW	AHRI Net MBH	AFUE	Fuel	Pump	Shp. Wgt. lbs	Trade Price
DCB75	DCB107503600103	HEATING	75	N/A	60	92.0%	NAT/LP	LESS	94	\$2,438
DCB100	DCB110003600103	HEATING	93.5	N/A	74	95.0%	NAT/LP	LESS	94	\$2,857
DCB125	DCB112503600103	HEATING	125	N/A	98	95.0%	NAT/LP	LESS	148	\$3,490
DCB165	DCB116503600103	HEATING	164	N/A	133	95.0%	NAT/LP	LESS	158	\$4,097
DCC115	DCC111503600103	COMBI	93.5	115.5	74	95.0%	NAT/LP	LESS	100	\$3,045
DCC150	DCC115003600103	COMBI	125	153	98	95.0%	NAT/LP	LESS	100	\$3,726
DCC205	DCC120503600103	COMBI	164	205	133	95.0%	NAT/LP	LESS	178	\$4,326
DCB75	DCB107503640103	HEATING	75	N/A	60	92.0%	NAT/LP	TACO ECM	103	\$2,609
DCB100	DCB110003640103	HEATING	93.5	N/A	74	95.0%	NAT/LP	TACO ECM	103	\$3,042
DCB125	DCB112503640103	HEATING	125	N/A	98	95.0%	NAT/LP	TACO ECM	148	\$3,666
DCB165	DCB116503640103	HEATING	164	N/A	133	95.0%	NAT/LP	TACO ECM	168	\$4,272
DCC115	DCC111503640103	COMBI	93.5	115.5	74	95.0%	NAT/LP	TACO ECM	100	\$3,226
DCC150	DCC115003640103	COMBI	125	153	98	95.0%	NAT/LP	TACO ECM	100	\$3,903
DCC205	DCC120503640103	COMBI	164	205	133	95.0%	NAT/LP	TACO ECM	178	\$4,500
DCB75	DCB107503620103	HEATING	75	N/A	60	92.0%	NAT/LP	GRUNDFOS	103	\$2,609
DCB100	DCB110003620103	HEATING	93.5	N/A	74	95.0%	NAT/LP	GRUNDFOS	103	\$3,042
DCB125	DCB112503620103	HEATING	125	N/A	98	95.0%	NAT/LP	GRUNDFOS	148	\$3,666
DCB165	DCB116503620103	HEATING	164	N/A	133	95.0%	NAT/LP	GRUNDFOS	168	\$4,272
DCC115	DCC111503620103	COMBI	93.5	115.5	74	95.0%	NAT/LP	GRUNDFOS	100	\$3,226
DCC150	DCC115003620103	COMBI	125	153	98	95.0%	NAT/LP	GRUNDFOS	100	\$3,903
DCC205	DCC120503620103	COMBI	164	205	133	95.0%	NAT/LP	GRUNDFOS	178	\$4,500

DCC/DCB (Use Parts Multiplier for All of the Following)

Model	Item Number	Description	Trade Price
DCC(B)	BD710487302V	OUTSIDE AIR SENSOR	\$45
DCC(B)	550003189	DHW SENSOR KIT	\$97
DCC(B)	240010266	FLOOR STAND KIT	\$811
DCC(B)	550003212	HEAT EXCHANGER CLEANING KIT	\$68

DCC/DCB Venting Adapters (Use Parts Multiplier for All of the Following)

DCC(B)	KHG714059113	TO CONVERT FROM CONCENTRIC TO 3" TWIN PIPE POLYPROPYLENE	\$21
DCC(B)	550003184	TWIN PIPE ADAPTER 60MM TO CPVC 3"	\$70
DCC(B)	KHG714089010	TO CONVERT FROM CONCENTRIC TO 3" TWIN PIPE POLYPROPYLENE	\$48
DCC(B)	550003403	TWIN PIPE ADAPTER 80MM TO CPVC 3"	\$131

NOTE: For 2" venting, a 3" x 2" reducer must be field supplied.



DCCF/DCBF Stainless Steel Floor Standing Combi & Heating Boilers

- MBH Input 75 - 164 (CH) / 115.5 - 205 (DHW)
- Up to 95% AFUE
ENERGY STAR® Certified
- [AI] Control Technology Recognizes Natural or LP Gas
No field conversion kit required.
- 6.9:1 Turndown Modulation Ratio in DHW Mode (115)
7:1 Turndown Modulation Ratio in DHW Mode (150/205)
4.5:1 Turndown Modulation Ratio in CH Mode (75)
5.6:1 Turndown Modulation Ratio in CH Mode (100/115)
5.7:1 Turndown Modulation Ratio in CH Mode (125/150)
5.5:1 Turndown Modulation Ratio in CH Mode (165/205)
- 2.5 gpm DHW @ 70°F Rise (115)
3.5 gpm DHW @ 70°F Rise (150)
5.0 gpm DHW @ 70°F Rise (205)
- LABOR SAVER™ Primary/Secondary Manifold Built-In
- Low Water Pressure Switch
- Compact, Floor Standing Design



General Information (See IOM for Complete Instructions)				
Model	DCBF-75/100/125	DCCF-115/150	DCBF-165	DCCF-205
Water Return/Supply	1 1/4" Copper	1 1/4" Copper	1 1/2" Copper	1 1/2" Copper
Gas	3/4" NPT	3/4" NPT	3/4" NPT	3/4" NPT
Condensate Drain	3/4" NPT	3/4" NPT	3/4" NPT	3/4" NPT
DHW Outlet (125 Optional)	3/4" SWT	1/2" SWT	NA	3/4" SWT
DHW (Cold Water) Inlet	NA	1/2" SWT	NA	3/4" SWT
Electrical	120 Volts AC, 60 hertz, 1 phase, less than 12 amps (15 amp circuit recommended)			
Water Content (Gallons)	1	1	1.25	1.25
Dimensions	A-Height	43.65"	43.65"	43.65"
	B-Width	24.7"	24.7"	24.7"
	C-Depth	17.46"	17.46"	23.55"

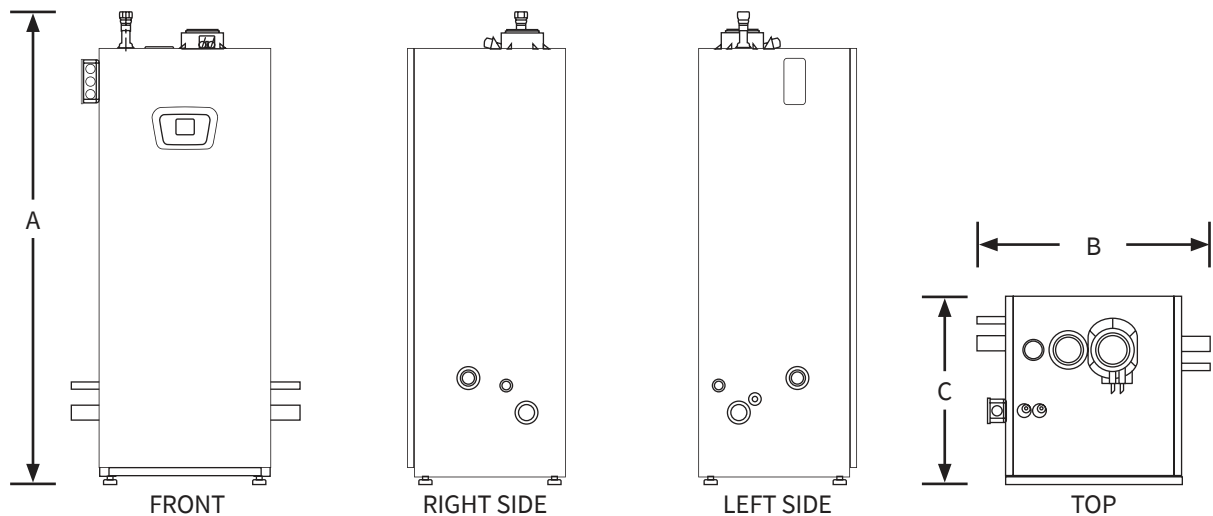

DCCF/DCBF - Stainless Steel Floor Standing Combi & Heating Boilers

Model	Item Number	Type	Input MBH CH	Input MBH DHW	AHRI Net MBH	AFUE	Fuel	Pump	Shp. Wgt. lbs	Trade Price
DCBF75	DCB107505600103	HEATING	75	N/A	60	92.0%	NAT/LP	LESS	117	\$2,752
DCBF100	DCB110005600103	HEATING	93.5	N/A	74	95.0%	NAT/LP	LESS	117	\$3,199
DCBF125	DCB112505600103	HEATING	125	N/A	98	95.0%	NAT/LP	LESS	148	\$3,892
DCBF165	DCB116505600103	HEATING	164	N/A	133	95.0%	NAT/LP	LESS	158	\$4,711
DCCF115	DCC111505600103	COMBI	93.5	115.5	74	95.0%	NAT/LP	LESS	148	\$3,460
DCCF150	DCC115005600103	COMBI	125	153	98	95.0%	NAT/LP	LESS	148	\$4,154
DCCF205	DCC120505600103	COMBI	164	205	133	95.0%	NAT/LP	LESS	168	\$4,976
DCBF75	DCB107505640103	HEATING	75	N/A	60	92.0%	NAT/LP	TACO ECM	126	\$2,923
DCBF100	DCB110005640103	HEATING	93.5	N/A	74	95.0%	NAT/LP	TACO ECM	126	\$3,377
DCBF125	DCB112505640103	HEATING	125	N/A	98	95.0%	NAT/LP	TACO ECM	148	\$4,072
DCBF165	DCB116505640103	HEATING	164	N/A	133	95.0%	NAT/LP	TACO ECM	158	\$4,913
DCCF115	DCC111505640103	COMBI	93.5	115.5	74	95.0%	NAT/LP	TACO ECM	148	\$3,637
DCCF150	DCC115005640103	COMBI	125	153	98	95.0%	NAT/LP	TACO ECM	148	\$4,335
DCCF205	DCC120505640103	COMBI	164	205	133	95.0%	NAT/LP	TACO ECM	168	\$5,177
DCBF75	DCB107505620103	HEATING	75	N/A	60	92.0%	NAT/LP	GRUNDFOS	126	\$2,923
DCBF100	DCB110005620103	HEATING	93.5	N/A	74	95.0%	NAT/LP	GRUNDFOS	126	\$3,377
DCBF125	DCB112505620103	HEATING	125	N/A	98	95.0%	NAT/LP	GRUNDFOS	148	\$4,072
DCBF165	DCB116505620103	HEATING	164	N/A	133	95.0%	NAT/LP	GRUNDFOS	158	\$4,913
DCCF115	DCC111505620103	COMBI	93.5	115.5	74	95.0%	NAT/LP	GRUNDFOS	148	\$3,637
DCCF150	DCC115005620103	COMBI	125	153	98	95.0%	NAT/LP	GRUNDFOS	148	\$4,335
DCCF205	DCC120505620103	COMBI	164	205	133	95.0%	NAT/LP	GRUNDFOS	168	\$5,177

DCCF/DCBF (Use Parts Multiplier for All of the Following)

Model	Item Number	Description	Trade Price
DCC(B)F	BD710487302V	OUTSIDE AIR SENSOR	\$45
DCC(B)F	550003189	DHW SENSOR KIT	\$97
DCC(B)F	550003212	HEAT EXCHANGER CLEANING KIT	\$68

DCCF/DCBF Venting Adapters (Use Parts Multiplier for All of the Following)

DCC(B)F	KHG714059113	TO CONVERT FROM CONCENTRIC TO 3" TWIN PIPE POLYPROPYLENE	\$21
DCC(B)F	550003184	TWIN PIPE ADAPTER 60MM TO CPVC 3"	\$70
DCC(B)F	KHG714089010	TO CONVERT FROM CONCENTRIC TO 3" TWIN PIPE POLYPROPYLENE	\$48
DCC(B)F	550003403	TWIN PIPE ADAPTER 80MM TO CPVC 3"	\$131

NOTE: For 2" venting, a 3" x 2" reducer must be field supplied.



DMG 240 Stainless Steel Wall Hung Heating Boilers

- MBH Input 241 (CH)
- 95% AFUE
ENERGY STAR® Certified
- LABOR SAVER™ Manifold Included
- 6.7:1 Modulation Turndown Ratio
- Wall Hung or Floor Base Kit Available
- Anti-Wind Function: Control automatically adjusts the fan speed to prevent loss of flame and lockouts
- Flame Stabilization: Control allows the flame to stabilize before modulating, preventing flame drop outs and recycling
- Optional Plug-and-Play, CSD-1 Kit Available



General Information (See IOM for Complete Instructions)		
Model	DMG 240	
Water Return/Supply	1"	
Gas	3/4" NPT	
Condensate Drain	3/4" NPT	
Electrical	120 Volts AC, 60 hertz, 1 phase, less than 12 amps (15 amp circuit recommended)	
Water Content (Gallons)	.8	
Dimensions	A-Height	31 1/16"
	B-Width	17 3/4"
	C-Depth	23"

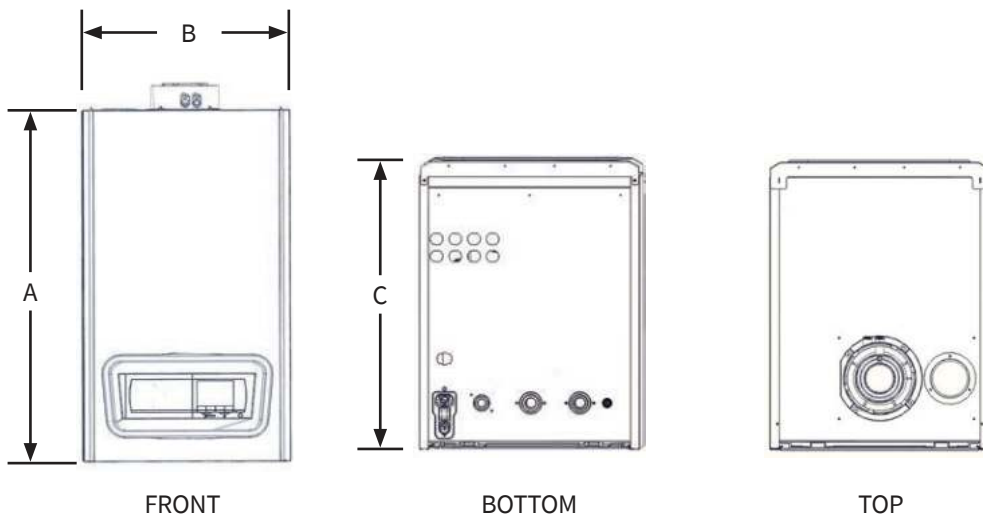

DMG 240 - Stainless Steel Wall Hung Heating Boilers								
Model	Item Number	Input MBH	AHRI Net MBH	AFUE	Fuel	Pump	Shp. Wgt. lbs	Trade Price
DMG 240	DMG124000600103	241	216	95.0%	NAT	LESS	120	\$7,232

DMG 240 (Use Parts Multiplier for All of the Following)			
Model	Item Number	Description	Trade Price
DMG 240	550003322	MANUAL RESET HIGH LIMIT KIT L4006E1109	\$318
DMG 240	550003323	MANUAL RESET LWCO KIT	\$306
DMG 240	550003332	CSD-1 KIT (INCLUDES HIGH LIMIT AND MANUAL RESET LWCO)	\$624
DMG 240	550003354	COMMON VENTING CHECK VALVE KIT	\$446
DMG 240	550003316	LP CONVERSION KIT	\$204
DMG 240	BD710487302V	OUTDOOR AIR SENSOR	\$45
DMG 240	550003189	DHW SENSOR KIT	\$97
DMG 240	550003304	FLOOR BASE KIT	\$630
DMG 240 Venting Adapters (Use Parts Multiplier for All of the Following)			
DMG 240	KHG714089010	TO CONVERT FROM CONCENTRIC TO 3" TWIN PIPE POLYPROPYLENE	\$48

DMG 380 Stainless Steel Floor Standing Heating Boilers

- MBH Input 379
- 95% Thermal Efficiency
- LABOR SAVER™ Manifold Included
- 10.5:1 Modulation Turndown Ratio
- Compact, Floor Standing Design
- Anti-Wind Function: Control automatically adjusts the fan speed to prevent loss of flame and lockouts
- Flame Stabilization: Control allows the flame to stabilize before modulating, preventing flame drop outs and recycling
- Optional Plug-and-Play, CSD-1 Kit Available



General Information (See IOM for Complete Instructions)		
Model	DMG 380	
Water Return/Supply	1 1/2"	
Gas	1" NPT	
Condensate Drain	3/4" NPT	
Electrical	120 Volts AC, 60 hertz, 1 phase, less than 12 amps (15 amp circuit recommended)	
Water Content (Gallons)	4.6	
Dimensions	A-Height	50"
	B-Width	23 5/8"
	C-Depth	25 1/2"

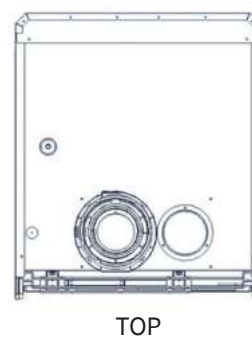
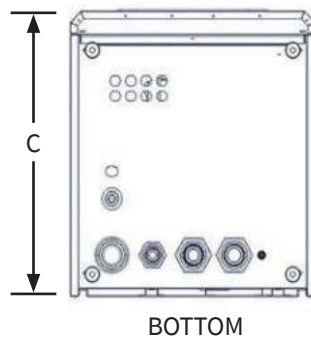
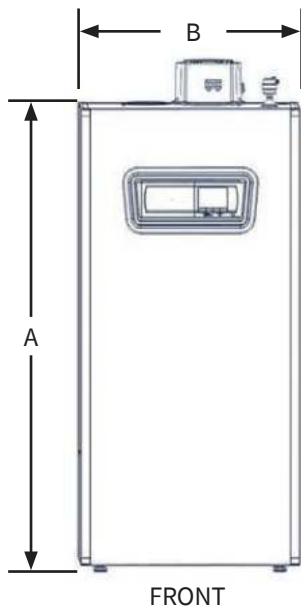

DMG 380 - Stainless Steel Floor Standing Heating Boilers

Model	Item Number	Input MBH	AHRI Net MBH	AFUE	Fuel	Pump	Shp. Wgt. lbs	Trade Price
DMG 380	DMG138000600103	379	303	95.0%	NAT	LESS	225	\$11,377

DMG 380 (Use Parts Multiplier for All of the Following)

Model	Item Number	Description	Trade Price
DMG 380	550003322	MANUAL RESET HIGH LIMIT KIT L4006E1109	\$318
DMG 380	550003323	MANUAL RESET LWCO KIT	\$306
DMG 380	550003332	CSD-1 KIT (INCLUDES HIGH LIMIT AND MANUAL RESET LWCO)	\$624
DMG 380	550003354	COMMON VENTING CHECK VALVE KIT	\$446
DMG 380	550003317	LP CONVERSION KIT	\$204
DMG 380	BD710487302V	OUTDOOR AIR SENSOR	\$45
DMG 380	550003189	DHW SENSOR KIT	\$97

DMG 380 Venting Adapters (Use Parts Multiplier for All of the Following)

DMG 380	BD7106314V	TO CONVERT FROM CONCENTRIC TO 4" TWIN PIPE POLYPROPYLENE	\$156
---------	------------	--	-------

NOTE: Twin pipe venting is polypropylene only. CPVC adapter not available.

















MBC Multiple Boiler Control

- Operation of up to Four Boilers
- LCD Display
- Push Buttons for Navigating Settings
- Warm Weather Shutdown (WWSD)
- Set Back Scheduling
- Boiler Stage Delay
- Boiler Rotation
- Combustion or Alarm Control Relay
- Flow or Combustion Air Proof Delay
- Energy Management System Compatible (0-10 or 2-10 Vdc)
- Sensors Included:
 - (1) Outdoor Sensor
 - (2) Water Temperature Sensors



MBC - Staging Control			
Model	Item Number	Description	Trade Price
AMB4B	AMB4BDK	MULTIPLE BOILER CONTROL (MBC) ON/OFF CONTROL	\$1,454
Additional Accessories			
AMB4B	240012663	WATER TEMPERATURE SENSOR	\$119
AMB4B	240012664	OUTDOOR SENSOR	\$119



VENTING

Coaxial Venting (Use Parts Multiplier for All of the Following)								
75/100/115	125/150	165/205	DMG 240	DMG 380	Image	Item Number	Description	Trade Price
X						KUG714059511	2"x4" (60/100mm)COAXIAL PIPE 3.28' (1m) L	\$48
X						KUG714059611	2"x4" (60/100mm)HORIZONTAL VENT TERM	\$60
X						KUG714059711	2"x4" (60/100mm)COAXIAL 90 ELBOWS	\$38
X						KUG714059811	2"x4" (60/100mm)COAXIAL 45 ELBOWS	\$38
X						KUG714135813	2"x4" (60/100mm)VERTICAL VENT TERM	\$142
	X	X				KHG714088512	3"x5" (80/125mm)COAXIAL PIPE 3.28' (1m) L	\$70
	X	X				KHG714088713	3"x5" (80/125mm)COAXIAL 90 ELBOWS	\$39
	X	X				KHG714088812	3"x5" (80/125mm)COAXIAL 45 ELBOWS	\$39
	X	X				KHG714088911	3"x5" (80/125mm)HORIZONTAL VENT TERM	\$80
	X	X				KHG714093512	3"x5" (80/125mm)VERTICAL VENT TERM	\$111
				X		KUG714133311	4"x6" (110/160mm)HORIZONTAL VENT TERM	\$294
				X		KUG714133411	4"x6" (110/160mm)VERTICAL VENT TERM	\$373
				X		KUG714133511	4"x6" (110/160mm)COAXIAL 45 ELBOWS	\$105
				X		KUG714133611	4"x6" (110/160mm)COAXIAL 90 ELBOWS	\$105
				X		KUG714133811	4"x6" (110/160mm)COAXIAL PIPE 3.28' (1m) L	\$144

VENTING

Twin Pipe Polypropylene Venting (Use Parts Multiplier for All of the Following)							
75/100/115 125/150	165/205	DMG 240	DMG 380	Image	Item Number	Description	Trade Price
X					KHG714059113	TO CONVERT FROM CONCENTRIC TO 3" TWIN PIPE POLYPROPYLENE	\$21
X	X	X			550003416	3" (80mm)VENTING CLAMP SINGLE WALL	\$45
X	X	X			550003452	3" (80mm)CLAMSHELL CLAMP (5PK)	\$44
X	X	X			KUG714132010	3" (80mm)HORIZONTAL VENT TERM	\$24
X	X	X			KUG714132110	3" (80mm)VERTICAL VENT TERM	\$59
X	X	X			550003734	3" (80mm)POLYPROPYLENE 45 ELBOWS W/ CLAMP	\$18
X	X	X			550003735	3" (80mm)POLYPROPYLENE 90 ELBOWS W/ CLAMP	\$18
X	X	X			550003767	3" (80mm)POLYPROPYLENE PIPE 3.28' (1m) L W/ CLAMP	\$26
	X	X			KHG714089010	TO CONVERT FROM CONCENTRIC TO 3" TWIN PIPE POLYPROPYLENE	\$48
			X		550003453	4" (110mm)CLAMSHELL CLAMP (5PK)	\$59
			X		BD7106314V	TO CONVERT FROM CONCENTRIC TO 4" TWIN PIPE POLYPROPYLENE	\$156
			X		KUG714132710	4" (110mm)HORIZONTAL VENT TERM	\$151
			X		KUG714132810	4" (110mm)VERTICAL VENT TERM	\$135
			X		550003731	4" (110mm)POLYPROPYLENE 45 ELBOWS W/ CLAMP	\$40
			X		550003732	4" (110mm)POLYPROPYLENE 90 ELBOWS W/ CLAMP	\$40
			X		550003733	4" (110mm)POLYPROPYLENE PIPE 3.28' (1m) L W/ CLAMP	\$54

VENTING

Twin Pipe CPVC Venting (Use Parts Multiplier for All of the Following)						
75/100/115 125/150 165/205	DMG 240	DMG 380	Image	Item Number	Description	Trade Price
X				550003184	TWIN PIPE ADAPTER 60MM TO CPVC 3"	\$70
	X	X		550003403	TWIN PIPE ADAPTER 80MM TO CPVC 3"	\$131



AT SERIES Electric Wall Hung Boilers

- 100% Efficient
- Compact Light Weight Wall Hung Design (70 lbs)
- Zero Emissions, Green Alternative (No Fossil Fuel, No Chimney, No Carbon Monoxide)
- Proven one piece cast iron heat exchanger
- Available in 2 or 4 element and modular boiler configurations:
 - 2 Element (4 capacities from 6 kW to 12 kW)
 - 4 Element (4 capacities from 12 kW to 24 kW)
 - Modular Boiler Configurations (40 kW+ for light commercial applications utilizing multiple boilers)
- 20 Year Limited Warranty (Residential)

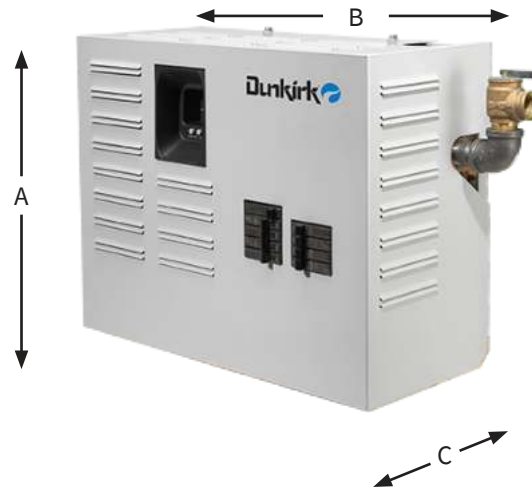

General Information (See IOM for Complete Instructions)		
Model		AT Series
Water Return/Supply		1 1/4" NPT
Dimensions	A-Height	16 15/32"
	B-Width	18 5/8"
	C-Depth	9 1/32"

AT Series Electric Boilers with Breakers							
Model	Item Number	Type	Size KW	Elem. No. & Size	bth/hr	Weight (lbs)	Trade Price
AT0623	AT062310C03	2-ELEMENT	6	2-3KW	20500	62	\$1,956
AT0824	AT082410C03	2-ELEMENT	8	2-4KW	27300	62	\$2,102
AT1025	AT102510C03	2-ELEMENT	10	2-5KW	34100	62	\$2,262
AT1226	AT122610C03	2-ELEMENT	12	2-6KW	41000	62	\$2,330
AT1243	AT124310C03	4-ELEMENT	12	4-3KW	41000	70	\$2,648
AT1644	AT164410C03	4-ELEMENT	16	4-4KW	54600	70	\$2,722
AT2045	AT204510C03	4-ELEMENT	20	4-5KW	68200	70	\$2,789
AT2446	AT244610C03	4-ELEMENT	24	4-6KW	82000	70	\$3,127
AT2800^	AT124310C03	MODULAR	28	4-3KW	95600	140	\$2,648
	AT164410C03			4-4KW			\$2,722
AT3200^	AT164410C03	MODULAR	32	4-4KW	109200	140	\$2,722
	AT164410C03			4-4KW			\$2,722
AT4000^	AT204510C03	MODULAR	40	4-5KW	136400	140	\$2,789
	AT204510C03			4-5KW			\$2,789

^When ordering modular boilers, order both part numbers listed. You will receive 2 boilers allowing for serial number tracking. Ratings are based on 240 operating voltage. Refer to IOM for reduced ratings based on 208 operating voltage.

AT Series Electric Boiler Service Parts (Use Parts Multiplier for the Following)			
Model	Item Number	Description	Trade Price
AT	1260006	Temperature/Pressure Gauge	\$32
AT	B27	Circuit Breaker 40 A - 2 Pole - G.E. THQP 240	\$78
AT	B28	Circuit Breaker 15 A - 1 Pole - G.E. THQP 115	\$51
AT	550003228	Pressure Vessel - Cast Iron, 4 Element	\$515
AT	550003227	Pressure Vessel - Cast Iron, 2 Element	\$357
AT	E13	Heating Element - 3KW/240 Volt	\$86
AT	E14	Heating Element - 4KW/240 Volt	\$107
AT	E15	Heating Element - 5KW/240 Volt	\$111
AT	E16	Heating Element - 6KW/240 Volt	\$117
AT	G12	Gasket - Heating Element	\$7
AT	VR-001.01	Relief Valve - 30 PSI	\$32
AT	B194	Neutral Terminal Block	\$101
AT	I25	Load Center Assembly - G.E. TLM812U2	\$169
AT	L9	Ground Connection Lug	\$16
AT	S47	Safety Limit Control (High Limit - Fixed Temp)	\$30
AT	Z59	Breaker Boiler Cover	\$250
AT	240004756	Brass Well	\$30
AT	E1	Elbow 3/4" x 90°	\$4
	119000002	Transformer 115/24V, 40 VA	\$44
AT	240010289	Water Temperature Sensor Kit	\$75
AT	240010295	Control Board - 2 Element, kit, includes wires	\$677
AT	240010296	Control Board - 4 Element, kit, includes wires	\$732
AT	109008918	Cabinet	\$151

XEB Cast Iron Induced Draft Chimney/Side Wall Vented Boilers

- MBH Input 42.5 - 187.5 (CH)
- Up to 84.4% AFUE
- Dependable Cast Iron Heat Exchanger with Cast Iron Push Nipples
- Honeywell High Limit/Electronic Ignition Control
 - Recessed under the boiler's protective jacket
 - Digital Temperature display and diagnostics
 - Plug in connection for the inducer fan
 - Plug in connection for the system pump
- Induced Draft Fan



General Information (See IOM for Complete Instructions)						
Model	XEB-2	XEB-3	XEB-4	XEB-5	XEB-6	
Water Return/Supply	1 1/4" NPT					
Gas	1/2" NPT					
Electrical	120 Volts AC, 60 hertz, 1 phase, less than 12 amps (15 amp circuit recommended)					
Water Content (Gallons)	1.75	3.00	4.25	5.50	6.75	
Dimensions	A-Height	29"	29"	29"	29"	
	B-Width	11"	14 1/4"	17 1/2"	20 3/4"	24"
	C-Depth	23 1/4"	23 1/4"	23 1/4"	23 1/4"	23 1/4"

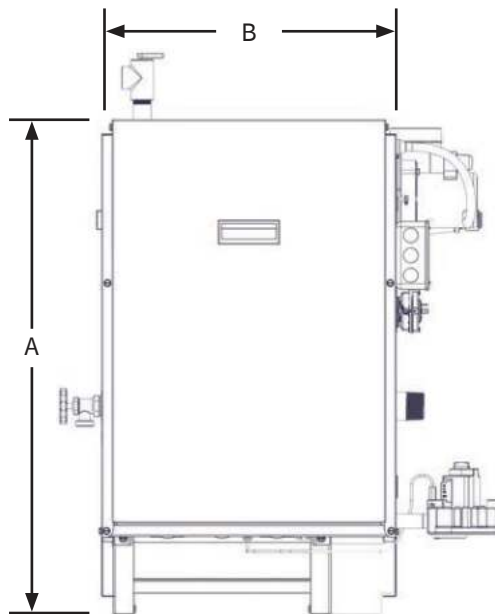

FRONT

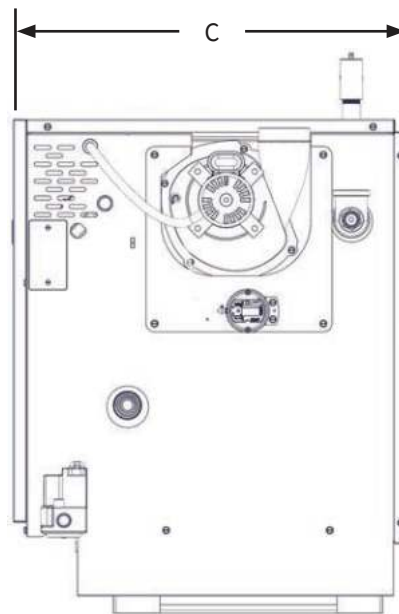

RIGHT SIDE

XEB - Cast Iron Induced Draft Chimney/Side Wall Vented Boilers									
Model	Item Number	Input MBH	Htg. Cap. MBH	AHRI Net MBH	AFUE	Fuel	Pump	Shp. Wgt. Lbs	Trade Price
XEB-2	XEB204203100303	42.5	36	31	84.4%	NAT	LESS	225	\$2,868
XEB-3	XEB307503100303	75	63	55	84.0%	NAT	LESS	265	\$3,247
XEB-4	XEB411203100303	112.5	95	82	84.0%	NAT	LESS	322	\$3,588
XEB-5	XEB515003100303	150	127	109	84.0%	NAT	LESS	370	\$4,032
XEB-6	XEB618703100303	187.5	158	135	84.0%	NAT	LESS	431	\$4,734
XEB-2	XEB204203140303	42.5	36	31	84.4%	NAT	TACO ECM	225	\$2,970
XEB-3	XEB307503140303	75	63	55	84.0%	NAT	TACO ECM	265	\$3,345
XEB-4	XEB411203140303	112.5	95	82	84.0%	NAT	TACO ECM	322	\$3,689
XEB-5	XEB515003140303	150	127	109	84.0%	NAT	TACO ECM	370	\$4,131
XEB-6	XEB618703140303	187.5	158	135	84.0%	NAT	TACO ECM	431	\$4,839
XEB-2	XEB204203120303	42.5	36	31	84.4%	NAT	GRUNDFOS	225	\$2,970
XEB-3	XEB307503120303	75	63	55	84.0%	NAT	GRUNDFOS	265	\$3,345
XEB-4	XEB411203120303	112.5	95	82	84.0%	NAT	GRUNDFOS	322	\$3,689
XEB-5	XEB515003120303	150	127	109	84.0%	NAT	GRUNDFOS	370	\$4,131
XEB-6	XEB618703120303	187.5	158	135	84.0%	NAT	GRUNDFOS	431	\$4,839
XEB-2	XEB204203130303	42.5	36	31	84.4%	NAT	B&G	225	\$2,970
XEB-3	XEB307503130303	75	63	55	84.0%	NAT	B&G	265	\$3,345
XEB-4	XEB411203130303	112.5	95	82	84.0%	NAT	B&G	322	\$3,689
XEB-5	XEB515003130303	150	127	109	84.0%	NAT	B&G	370	\$4,131
XEB-6	XEB618703130303	187.5	158	135	84.0%	NAT	B&G	431	\$4,839

XEB - LP									
XEB-2	XEB204213100303	42.5	36	31	84.4%	LP	LESS	225	\$2,937
XEB-3	XEB307513100303	75	63	55	84.0%	LP	LESS	265	\$3,317
XEB-4	XEB411213100303	112.5	95	82	84.0%	LP	LESS	322	\$3,655
XEB-5	XEB515013100303	150	127	109	84.0%	LP	LESS	370	\$4,099
XEB-6	XEB618713100303	187.5	158	135	84.0%	LP	LESS	431	\$4,802
XEB-2	XEB204213140303	42.5	36	31	84.4%	LP	TACO ECM	225	\$3,037
XEB-3	XEB307513140303	75	63	55	84.0%	LP	TACO ECM	265	\$3,413
XEB-4	XEB411213140303	112.5	95	82	84.0%	LP	TACO ECM	322	\$3,758
XEB-5	XEB515013140303	150	127	109	84.0%	LP	TACO ECM	370	\$4,200
XEB-6	XEB618713140303	187.5	158	135	84.0%	LP	TACO ECM	431	\$4,909
XEB-2	XEB204213120303	42.5	36	31	84.4%	LP	GRUNDFOS	225	\$3,037
XEB-3	XEB307513120303	75	63	55	84.0%	LP	GRUNDFOS	265	\$3,413
XEB-4	XEB411213120303	112.5	95	82	84.0%	LP	GRUNDFOS	322	\$3,758
XEB-5	XEB515013120303	150	127	109	84.0%	LP	GRUNDFOS	370	\$4,200
XEB-6	XEB618713120303	187.5	158	135	84.0%	LP	GRUNDFOS	431	\$4,909

XEB - Cast Iron Induced Draft Chimney/Side Wall Vented Boilers (Cont.)

Model	Item Number	Input MBH	Htg. Cap. MBH	AHRI Net MBH	AFUE	Fuel	Pump	Shp. Wgt. Lbs	Trade Price
XEB-2	XEB204213130303	42.5	36	31	84.4%	LP	B&G	225	\$3,037
XEB-3	XEB307513130303	75	63	55	84.0%	LP	B&G	265	\$3,413
XEB-4	XEB411213130303	112.5	95	82	84.0%	LP	B&G	322	\$3,758
XEB-5	XEB515013130303	150	127	109	84.0%	LP	B&G	370	\$4,200
XEB-6	XEB618713130303	187.5	158	135	84.0%	LP	B&G	431	\$4,909

XEB - High Altitude*

XEB-2	XEB204203145303	42.5*	36*	31*	84.4%	NAT	TACO ECM	225	\$2,970
XEB-3	XEB307503145303	75*	63*	55*	84.0%	NAT	TACO ECM	265	\$3,345
XEB-4	XEB411203145303	112.5*	95*	82*	84.0%	NAT	TACO ECM	322	\$3,689
XEB-5	XEB515003145303	150*	127*	109*	84.0%	NAT	TACO ECM	370	\$4,131
XEB-6	XEB618703145303	187.5*	158*	135*	84.0%	NAT	TACO ECM	431	\$4,839

XEB-2	XEB204203125303	42.5*	36*	31*	84.4%	NAT	GRUNDFOS	225	\$2,970
XEB-3	XEB307503125303	75*	63*	55*	84.0%	NAT	GRUNDFOS	265	\$3,345
XEB-4	XEB411203125303	112.5*	95*	82*	84.0%	NAT	GRUNDFOS	322	\$3,689
XEB-5	XEB515003125303	150*	127*	109*	84.0%	NAT	GRUNDFOS	370	\$4,131
XEB-6	XEB618703125303	187.5*	158*	135*	84.0%	NAT	GRUNDFOS	431	\$4,839

*** High Altitude - Capacity Reduces with Elevation. Refer to IOM for Actual Capacity Ratings.**

High Altitude Models ship with conversion kit (which must be field installed) at sea level with 5000' elevation orifices - consult factory for other elevations.

XEB (Use Parts Multiplier for All of the Following)

Model	Item Number	Description	Trade Price
XEB	550002722	NATURAL TO LP CONVERSION KIT (ALL SIZES)	\$114
XEB	43300660	LP TO NATURAL CONVERSION KIT (ALL SIZES)	\$125
XEB	14629014	4" THIMBLE (SIMPSON #915295)	\$54
XEB (2-5)	14629010	TJERNLUND VH-1-3" SIDE WALL VENT HOOD (XEB-2 TO XEB-5)	\$317
XEB (6)	14629011	TJERNLUND VH-1-4" SIDE WALL VENT HOOD (XEB-6)	\$376
XEB (2-5)	14624002	FILL-TROL #110 FOR WATER BOILERS 150 MBH OR LESS	\$401
XEB (6)	14624003	FILL-TROL #111 FOR WATER BOILERS OVER 150 MBH	\$557

**This page is intentionally left blank,
products continue on the following page.**

DXL-K Cast Iron Chimney Vented Boilers

- MBH Input 59 - 235 (CH)
- 84% AFUE
- Dependable Cast Iron Heat Exchanger
- Hydrostat Fuel Smart Control
- Digital temperature display and diagnostics
- Plug in connection for the vent damper
- Plug in connection for the system pump
- Control monitors water temperature and delays burner start until residual heat has been transferred to the system for maximum efficiency.



General Information (See IOM for Complete Instructions)							
Model	DXL-060K	DXL-095K	DXL-120K	DXL-150K	DXL-175K	DXL-205K	DXL-235K
Water Return/Supply	1 1/4" NPT						
Gas	1/2" NPT				3/4" NPT		
Electrical	120 Volts AC, 60 hertz, 1 phase, less than 12 amps (15 amp circuit recommended)						
Water Content (Gallons)	1.9	2.3	2.8	3.2	3.7	4.1	4.6
A-Height	32 1/8"	32 1/8"	32 1/8"	32 1/8"	32 1/8"	32 1/8"	32 1/8"
B-Width	13 3/8"	13 1/2"	16 1/4"	19"	21 7/8"	27 1/2"	27 1/2"
C-Depth	26"	26"	26"	26"	26"	26"	26"

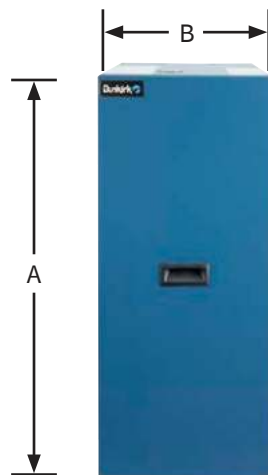

FRONT



LEFT SIDE

DXL-K - Cast Iron Chimney Vented Boilers

Model	Item Number	Input MBH	Htg. Cap. MBH	AHRI Net MBH	AFUE	Fuel	Pump	Shp. Wgt. lbs	Trade Price
DXL-060K	DXL306003200403	59	50	43	84.0%	NAT	LESS	215	\$2,943
DXL-095K	DXL409503200403	92.5	78	68	84.0%	NAT	LESS	250	\$3,160
DXL-120K	DXL512003200403	120	101	88	84.0%	NAT	LESS	295	\$3,375
DXL-150K	DXL615003200403	149	125	109	84.0%	NAT	LESS	335	\$3,670
DXL-175K	DXL717503200403	175	147	128	84.0%	NAT	LESS	385	\$4,255
DXL-205K	DXL820503200403	205	172	150	84.0%	NAT	LESS	420	\$4,559
DXL-235K	DXL923503200403	235	197	171	84.0%	NAT	LESS	465	\$5,144
DXL-060K	DXL306003240403	59	50	43	84.0%	NAT	TACO ECM	215	\$3,049
DXL-095K	DXL409503240403	92.5	78	68	84.0%	NAT	TACO ECM	250	\$3,268
DXL-120K	DXL512003240403	120	101	88	84.0%	NAT	TACO ECM	295	\$3,484
DXL-150K	DXL615003240403	149	125	109	84.0%	NAT	TACO ECM	335	\$3,777
DXL-175K	DXL717503240403	175	147	128	84.0%	NAT	TACO ECM	385	\$4,363
DXL-205K	DXL820503240403	205	172	150	84.0%	NAT	TACO ECM	420	\$4,667
DXL-235K	DXL923503240403	235	197	171	84.0%	NAT	TACO ECM	465	\$5,253
DXL-060K	DXL306003220403	59	50	43	84.0%	NAT	GRUNDFOS	215	\$3,049
DXL-095K	DXL409503220403	92.5	78	68	84.0%	NAT	GRUNDFOS	250	\$3,268
DXL-120K	DXL512003220403	120	101	88	84.0%	NAT	GRUNDFOS	295	\$3,484
DXL-150K	DXL615003220403	149	125	109	84.0%	NAT	GRUNDFOS	335	\$3,777
DXL-175K	DXL717503220403	175	147	128	84.0%	NAT	GRUNDFOS	385	\$4,363
DXL-205K	DXL820503220403	205	172	150	84.0%	NAT	GRUNDFOS	420	\$4,667
DXL-235K	DXL923503220403	235	197	171	84.0%	NAT	GRUNDFOS	465	\$5,253
DXL-060K	DXL306003230403	59	50	43	84.0%	NAT	B&G	215	\$3,049
DXL-095K	DXL409503230403	92.5	78	68	84.0%	NAT	B&G	250	\$3,268
DXL-120K	DXL512003230403	120	101	88	84.0%	NAT	B&G	295	\$3,484
DXL-150K	DXL615003230403	149	125	109	84.0%	NAT	B&G	335	\$3,777
DXL-175K	DXL717503230403	175	147	128	84.0%	NAT	B&G	385	\$4,363
DXL-205K	DXL820503230403	205	172	150	84.0%	NAT	B&G	420	\$4,667
DXL-235K	DXL923503230403	235	197	171	84.0%	NAT	B&G	465	\$5,253

DXL-K - LP

DXL-060K	DXL306013200403	59	50	43	84.0%	LP	LESS	215	\$3,009
DXL-095K	DXL409513200403	92.5	78	68	84.0%	LP	LESS	250	\$3,227
DXL-120K	DXL512013200403	120	101	88	84.0%	LP	LESS	295	\$3,443
DXL-150K	DXL615013200403	149	125	109	84.0%	LP	LESS	335	\$3,737
DXL-175K	DXL717513200403	175	147	128	84.0%	LP	LESS	385	\$4,322
DXL-205K	DXL820513200403	205	172	150	84.0%	LP	LESS	420	\$4,626
DXL-235K	DXL923513200403	235	197	171	84.0%	LP	LESS	465	\$5,213
DXL-060K	DXL306013240403	59	50	43	84.0%	LP	TACO ECM	215	\$3,116
DXL-095K	DXL409513240403	92.5	78	68	84.0%	LP	TACO ECM	250	\$3,336
DXL-120K	DXL512013240403	120	101	88	84.0%	LP	TACO ECM	295	\$3,551
DXL-150K	DXL615013240403	149	125	109	84.0%	LP	TACO ECM	335	\$3,846
DXL-175K	DXL717513240403	175	147	128	84.0%	LP	TACO ECM	385	\$4,430
DXL-205K	DXL820513240403	205	172	150	84.0%	LP	TACO ECM	420	\$4,734
DXL-235K	DXL923513240403	235	197	171	84.0%	LP	TACO ECM	465	\$5,320

DXL-K - Cast Iron Chimney Vented Boilers									
Model	Item Number	Input MBH	Htg. Cap. MBH	AHRI Net MBH	AFUE	Fuel	Pump	Shp. Wgt. lbs	Trade Price
DXL-060K	DXL306013220403	59	50	43	84.0%	LP	GRUNDFOS	215	\$3,116
DXL-095K	DXL409513220403	92.5	78	68	84.0%	LP	GRUNDFOS	250	\$3,336
DXL-120K	DXL512013220403	120	101	88	84.0%	LP	GRUNDFOS	295	\$3,551
DXL-150K	DXL615013220403	149	125	109	84.0%	LP	GRUNDFOS	335	\$3,846
DXL-175K	DXL717513220403	175	147	128	84.0%	LP	GRUNDFOS	385	\$4,430
DXL-205K	DXL820513220403	205	172	150	84.0%	LP	GRUNDFOS	420	\$4,734
DXL-235K	DXL923513220403	235	197	171	84.0%	LP	GRUNDFOS	465	\$5,320

DXL-K - High Altitude*									
DXL-060K	DXL306003245403	59*	50*	43*	84.0%	NAT	TACO ECM	215	\$3,049
DXL-095K	DXL409503245403	92.5*	78*	68*	84.0%	NAT	TACO ECM	250	\$3,268
DXL-120K	DXL512003245403	120*	101*	88*	84.0%	NAT	TACO ECM	295	\$3,484
DXL-150K	DXL615003245403	149*	125*	109*	84.0%	NAT	TACO ECM	335	\$3,777
DXL-175K	DXL717503245403	175*	147*	128*	84.0%	NAT	TACO ECM	385	\$4,363
DXL-205K	DXL820503245403	205*	172*	150*	84.0%	NAT	TACO ECM	420	\$4,667
DXL-235K	DXL923503245403	235*	197*	171*	84.0%	NAT	TACO ECM	465	\$5,253

* High Altitude - Capacity Reduces with Elevation. Refer to IOM for Actual Capacity Ratings.

High Altitude Models ship with conversion kit (which must be field installed) at sea level with 5000' elevation orifices - consult factory for other elevations.

DXL-K (Use Parts Multiplier for All of the Following)			
Model	Item Number	Description	Trade Price
DXL-K	550003778	CONVERSION KIT NAT. TO LP	\$92
DXL-K	550003884	CONVERSION KIT LP TO NAT.	\$102
DXL-K	14624002	FILL-TROL #110 FOR WATER BOILERS 150 MBH OR LESS	\$401
DXL-K	14624003	FILL-TROL #111 FOR WATER BOILERS OVER 150 MBH	\$557

**This page is intentionally left blank,
products continue on the following page.**

WPSB Cast Iron Integral Draft Diverter Boilers

- MBH Input 75 - 299 (CH)
- Up to 84.1% AFUE
- Dependable Cast Iron Heat Exchanger with Cast Iron Push Nipples
- Hydrolevel FuelSmart Control
- Digital temperature display and diagnostics
- Plug in connection for the vent damper
- Plug in connection for the system pump
- Low Water Cut Off (LWCO)
- Control monitors water temperature and delays burner start until residual heat has been transferred to the system for maximum efficiency



General Information (See IOM for Complete Instructions)							
Model	WPSB-3	WPSB-4	WPSB-5	WPSB-6	WPSB-7	WPSB-8	WPSB-9
Water Return/Supply	1 1/4" NPT						
Gas	1/2" NPT						
Electrical	120 Volts AC, 60 hertz, 1 phase, less than 12 amps (15 amp circuit recommended)						
Water Content (Gallons)	6.3	8.1	9.9	11.7	13.5	15.3	17.2
Dimensions	A-Height	36 3/8"	36 3/8"	36 3/8"	36 3/8"	36 3/8"	36 3/8"
	B-Width	11 1/4"	14 1/2"	17 3/4"	21"	24 1/4"	30 3/4"
	C-Depth	26 1/2"	26 1/2"	26 1/2"	26 1/2"	26 1/2"	26 1/2"

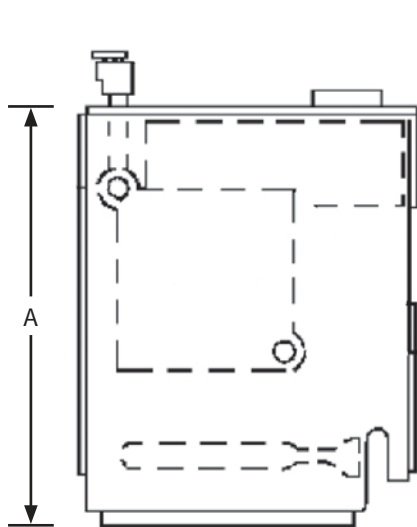

LEFT SIDE

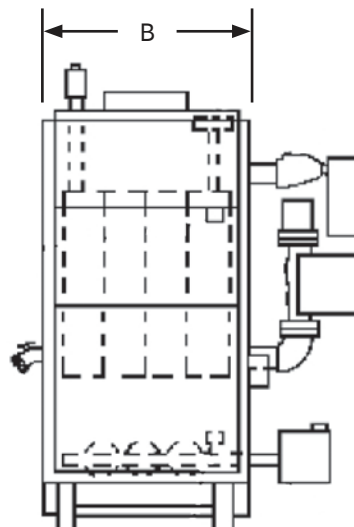

FRONT

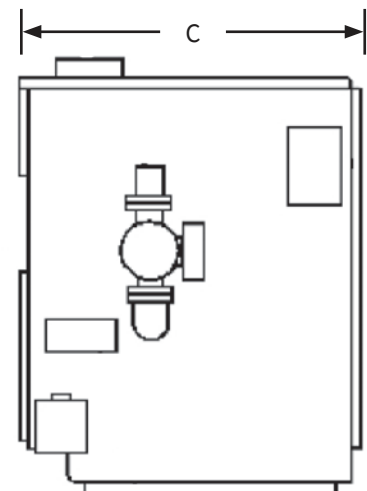

RIGHT SIDE

WPSB - Cast Iron Integral Draft Diverter Boilers									
Model	Item Number	Input MBH	Htg. Cap. MBH	AHRI Net MBH	AFUE	Fuel	Pump	Shp. Wgt. lbs	Trade Price
WPSB-3D	WPS307503200303	75	63	55	84.0%	NAT	LESS	315	\$3,256
WPSB-4D	WPS411203200303	112.5	94	82	84.0%	NAT	LESS	377	\$3,612
WPSB-5D	WPS515003200303	150	126	110	84.1%	NAT	LESS	453	\$3,987
WPSB-6D	WPS618703200303	187.5	157	137	84.1%	NAT	LESS	534	\$4,473
WPSB-7D	WPS722503200303	225	188	163	84.0%	NAT	LESS	601	\$4,895
WPSB-8D	WPS826203200303	262	221	191	84.0%	NAT	LESS	665	\$5,278
WPSB-9D	WPS929903200303	299	252	218	84.0%	NAT	LESS	750	\$6,098
WPSB-3D	WPS307503240303	75	63	55	84.0%	NAT	TACO ECM	315	\$3,356
WPSB-4D	WPS411203240303	112.5	94	82	84.0%	NAT	TACO ECM	377	\$3,712
WPSB-5D	WPS515003240303	150	126	110	84.1%	NAT	TACO ECM	453	\$4,085
WPSB-6D	WPS618703240303	187.5	157	137	84.1%	NAT	TACO ECM	534	\$4,575
WPSB-7D	WPS722503240303	225	188	163	84.0%	NAT	TACO ECM	601	\$4,995
WPSB-8D	WPS826203240303	262	221	191	84.0%	NAT	TACO ECM	665	\$5,377
WPSB-9D	WPS929903240303	299	252	218	84.0%	NAT	TACO ECM	750	\$6,198
WPSB-3D	WPS307503220303	75	63	55	84.0%	NAT	GRUNDFOS	315	\$3,356
WPSB-4D	WPS411203220303	112.5	94	82	84.0%	NAT	GRUNDFOS	377	\$3,712
WPSB-5D	WPS515003220303	150	126	110	84.1%	NAT	GRUNDFOS	453	\$4,085
WPSB-6D	WPS618703220303	187.5	157	137	84.1%	NAT	GRUNDFOS	534	\$4,575
WPSB-7D	WPS722503220303	225	188	163	84.0%	NAT	GRUNDFOS	601	\$4,995
WPSB-8D	WPS826203220303	262	221	191	84.0%	NAT	GRUNDFOS	665	\$5,377
WPSB-9D	WPS929903220303	299	252	218	84.0%	NAT	GRUNDFOS	750	\$6,198
WPSB-3D	WPS307503230303	75	63	55	84.0%	NAT	B&G	315	\$3,356
WPSB-4D	WPS411203230303	112.5	94	82	84.0%	NAT	B&G	377	\$3,712
WPSB-5D	WPS515003230303	150	126	110	84.1%	NAT	B&G	453	\$4,085
WPSB-6D	WPS618703230303	187.5	157	137	84.1%	NAT	B&G	534	\$4,575
WPSB-7D	WPS722503230303	225	188	163	84.0%	NAT	B&G	601	\$4,995
WPSB-8D	WPS826203230303	262	221	191	84.0%	NAT	B&G	665	\$5,377
WPSB-9D	WPS929903230303	299	252	218	84.0%	NAT	B&G	750	\$6,198
WPSB - LP									
WPSB-3DP	WPS307513200303	70	59	51	84.0%	LP	LESS	315	\$3,324
WPSB-4DP	WPS411213200303	105	88	77	84.0%	LP	LESS	377	\$3,679
WPSB-5DP	WPS515013200303	140	118	103	84.1%	LP	LESS	453	\$4,052
WPSB-6DP	WPS618713200303	175	147	128	84.1%	LP	LESS	534	\$4,543
WPSB-7DP	WPS722513200303	210	176	153	84.0%	LP	LESS	601	\$4,963
WPSB-8DP	WPS826213200303	245	208	179	84.0%	LP	LESS	665	\$5,347
WPSB-9DP	WPS929913200303	280	237	204	84.0%	LP	LESS	750	\$6,168
WPSB-3DP	WPS307513240303	70	59	51	84.0%	LP	TACO ECM	315	\$3,423
WPSB-4DP	WPS411213240303	105	88	77	84.0%	LP	TACO ECM	377	\$3,780
WPSB-5DP	WPS515013240303	140	118	103	84.1%	LP	TACO ECM	453	\$4,155
WPSB-6DP	WPS618713240303	175	147	128	84.1%	LP	TACO ECM	534	\$4,644
WPSB-7DP	WPS722513240303	210	176	153	84.0%	LP	TACO ECM	601	\$5,066
WPSB-8DP	WPS826213240303	245	208	179	84.0%	LP	TACO ECM	665	\$5,445
WPSB-9DP	WPS929913240303	280	237	204	84.0%	LP	TACO ECM	750	\$6,267

WPSB - Cast Iron Integral Draft Diverter Boilers (Cont.)

Model	Item Number	Input MBH	Htg. Cap. MBH	AHRI Net MBH	AFUE	Fuel	Pump	Shp. Wgt. lbs	Trade Price
WPSB-3DP	WPS307513220303	70	59	51	84.0%	LP	GRUNDFOS	315	\$3,423
WPSB-4DP	WPS411213220303	105	88	77	84.0%	LP	GRUNDFOS	377	\$3,780
WPSB-5DP	WPS515013220303	140	118	103	84.1%	LP	GRUNDFOS	453	\$4,155
WPSB-6DP	WPS618713220303	175	147	128	84.1%	LP	GRUNDFOS	534	\$4,644
WPSB-7DP	WPS722513220303	210	176	153	84.0%	LP	GRUNDFOS	601	\$5,066
WPSB-8DP	WPS826213220303	245	208	179	84.0%	LP	GRUNDFOS	665	\$5,445
WPSB-9DP	WPS929913220303	280	237	204	84.0%	LP	GRUNDFOS	750	\$6,267
WPSB-3DP	WPS307513230303	70	59	51	84.0%	LP	B&G	315	\$3,423
WPSB-4DP	WPS411213230303	105	88	77	84.0%	LP	B&G	377	\$3,780
WPSB-5DP	WPS515013230303	140	118	103	84.1%	LP	B&G	453	\$4,155
WPSB-6DP	WPS618713230303	175	147	128	84.1%	LP	B&G	534	\$4,644
WPSB-7DP	WPS722513230303	210	176	153	84.0%	LP	B&G	601	\$5,066
WPSB-8DP	WPS826213230303	245	208	179	84.0%	LP	B&G	665	\$5,445
WPSB-9DP	WPS929913230303	280	237	204	84.0%	LP	B&G	750	\$6,267

WPSB - High Altitude*

WPSB-3D	WPS307503245303	75*	63*	55*	84.0%	NAT	TACO ECM	315	\$3,356
WPSB-4D	WPS411203245303	112.5*	94*	82*	84.0%	NAT	TACO ECM	377	\$3,712
WPSB-5D	WPS515003245303	150*	126*	110*	84.1%	NAT	TACO ECM	453	\$4,085
WPSB-6D	WPS618703245303	187.5*	157*	137*	84.1%	NAT	TACO ECM	534	\$4,575
WPSB-7D	WPS722503245303	225*	188*	163*	84.0%	NAT	TACO ECM	601	\$4,995
WPSB-8D	WPS826203245303	262*	221*	191*	84.0%	NAT	TACO ECM	665	\$5,377
WPSB-9D	WPS929903245303	299*	252*	218*	84.0%	NAT	TACO ECM	750	\$6,198

*** High Altitude - Capacity Reduces with Elevation. Refer to IOM for Actual Capacity Ratings.**

WPSB (Use Parts Multiplier for All of the Following) Cont.

Model	Item Number	Description	Trade Price
WPSB	550004168	3 -9 SECTION NATURAL GAS TO LP GAS CONVERSION KIT	\$125
WPSB-4D	43300632	4 SECTION LP GAS TO NATURAL GAS CONVERSION KIT	\$252
WPSB-5D	43300633	5 SECTION LP GAS TO NATURAL GAS CONVERSION KIT	\$256
WPSB-6D	43300634	6 SECTION LP GAS TO NATURAL GAS CONVERSION KIT	\$250
WPSB-7D	43300635	7 SECTION LP GAS TO NATURAL GAS CONVERSION KIT	\$252
WPSB-8D	43300636	8 SECTION LP GAS TO NATURAL GAS CONVERSION KIT	\$254
WPSB-9D	43300637	9 SECTION LP GAS TO NATURAL GAS CONVERSION KIT	\$254
WPSB	14624002	FILL-TROL FOR WATER BOILERS 150 MBH OR LESS	\$401
WPSB	14624003	FILL-TROL FOR WATER BOILERS OVER 150 MBH	\$557

**This page is intentionally left blank,
products continue on the following page.**

PSB Cast Iron Steam Boilers

- MBH Input 75 - 299 (CH)
- Up to 82.7% AFUE
- Dependable Cast Iron Heat Exchanger with Cast Iron Push Nipples
- LWCO (Probe Type) Includes Pressure High Limit Control, Pressure Gauge, Gauge Glass
- Low profile compact design makes it ideal for low clearance installations
- Easy piping features with 2" single and dual piping riser options (depending on boiler size), simplifying replacement piping
- Atmospheric Chimney Vent Boiler with Integral Draft Hood and Vent Damper
- Stainless Steel burner



General Information (See IOM for Complete Instructions)							
Model	PSB-3D	PSB-4D	PSB-5D	PSB-6D	PSB-7D	PSB-8D	PSB-9D
Return/Supply Tappings	2 1/2" NPT						
Gas	1/2" NPT			3/4" NPT			
Electrical	120 Volts AC, 60 hertz, 1 phase, less than 12 amps (15 amp circuit recommended)						
Water Content (Gallons)	2.6	3.8	5	6.2	7.4	8.6	9.5
Dimensions	A-Height	36 3/8"	36 3/8"	36 3/8"	36 3/8"	36 3/8"	36 3/8"
	B-Width	11 1/4"	14 1/2"	17 3/4"	21"	24 1/4"	30 3/4"
	C-Depth	26 1/2"	26 1/2"	26 1/2"	26 1/2"	26 1/2"	26 1/2"

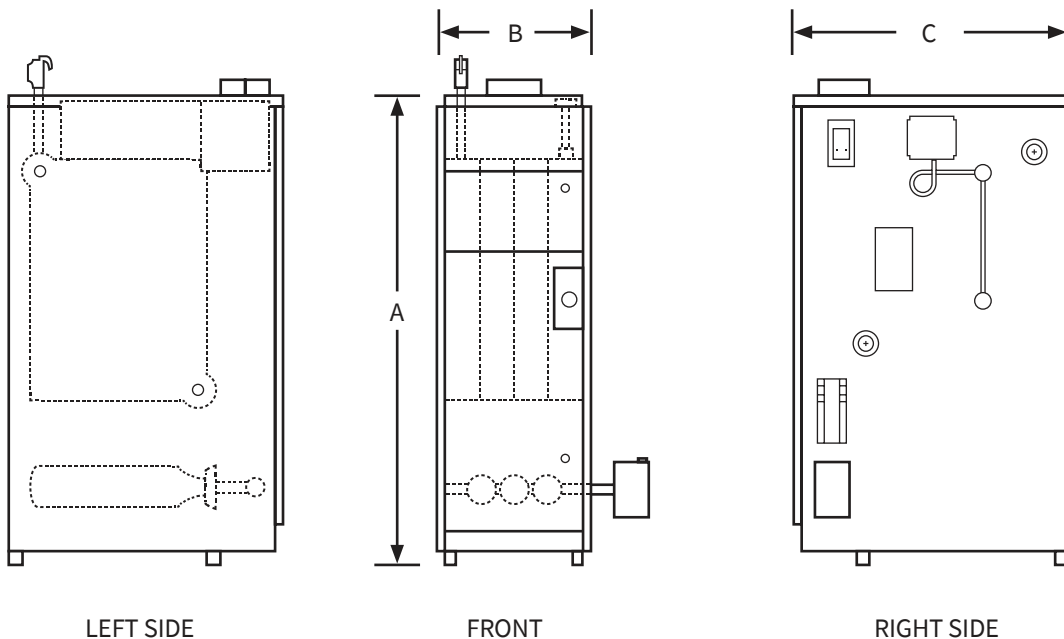

PSB - Cast Iron Steam Boilers									
Model	Item Number	Input MBH	Htg. Cap. MBH	AHRI Net MBH	AHRI Net SQ. FT. Steam	AFUE	Fuel	Shp. Wgt. lbs	Trade Price
PSB-3D	353001000	75	62	47	195	82.7%	NAT	297	\$3,799
PSB-4D	354001000	112	91	68	283	82.0%	NAT	368	\$4,149
PSB-5D	355001000	150	122	92	383	82.0%	NAT	440	\$4,676
PSB-6D	356001000	187	153	115	479	82.0%	NAT	512	\$5,325
PSB-7D	357001000	225	183	137	570	82.0%	NAT	584	\$5,871
PSB-8D	358001000	262	214	161	670	82.0%	NAT	659	\$6,494
PSB-9D	359001000	299	245	184	766	82.0%	NAT	736	\$6,839
PSB (Use Parts Multiplier for All of the Following)									
Model	Item Number	Description							Trade Price
PSB-3D	43300723	3 SECTION NATURAL GAS TO LP GAS CONVERSION KIT							\$68
PSB-4D	43300724	4 SECTION NATURAL GAS TO LP GAS CONVERSION KIT							\$68
PSB-5D	43300725	5 SECTION NATURAL GAS TO LP GAS CONVERSION KIT							\$68
PSB-6D	43300726	6 SECTION NATURAL GAS TO LP GAS CONVERSION KIT							\$80
PSB-7D	43300727	7 SECTION NATURAL GAS TO LP GAS CONVERSION KIT							\$80
PSB-8D	43300728	8 SECTION NATURAL GAS TO LP GAS CONVERSION KIT							\$80
PSB-9D	43300729	9 SECTION NATURAL GAS TO LP GAS CONVERSION KIT							\$80
PSB-4D	43300632	4 SECTION LP TO NATURAL GAS CONVERSION KIT							\$252
PSB-5D	43300633	5 SECTION LP TO NATURAL GAS CONVERSION KIT							\$256
PSB-6D	43300634	6 SECTION LP TO NATURAL GAS CONVERSION KIT							\$250
PSB-7D	43300635	7 SECTION LP TO NATURAL GAS CONVERSION KIT							\$252
PSB-8D	43300636	8 SECTION LP TO NATURAL GAS CONVERSION KIT							\$254
PSB-9D	43300637	9 SECTION LP TO NATURAL GAS CONVERSION KIT							\$254
PSB	1630001	MCDONNELL & MILLER WF-2U-24 ELECTRONIC WATER FEEDER							\$642

D249 Cast Iron Commercial Steam Boilers

D249 Boiler Bases are pre-assembled at the factory with burner manifold, burner orifices, gas valves and electronic ignition installed; ready for field installation of the pre-tested sections and appropriate packages.

Electronic Ignition Base Standard Equipment:

- Base
- Fire Door
- Burner Orifice
- Manifold
- Main and Pilot Burner
- Electronic Pilot Gas Valve
- Intermittent Pilot Module
- Complete Jacket Assembly

Steam Trim Package:

- Low Water Cut-Off
- Glass Gauge Set
- Safety Valve
- Steam Gauge
- Pressure Limit
- Drain Valve



Plug 'N Play Harness and Junction Box

Individual base and junction box controls are designed for easy installation. The entire boiler links together in a snap with a color-coded factory supplied wiring harness

CSD-1 Options

Available with a CSD-1 option to comply with CSD-1 standards where required by building code. The CSD-1 option provides the increased number of controls and safety devices required to meet CSD-1 standards.

General Information (See IOM for Complete Instructions)			
	Right & Left End Tappings	Opening	Size
	Return/Supply	A	4"
	Primary LWCO & Guage Glass Set	B	1/2"
	Drain, Left End	C	3/4"
	Drain, Right End	C	3/4"
	Plugged	D	1/2"
	Accessories	E	1"
	Safety Valve	F*	1"
	Plugged or Electronic (Probe Type) LWCO	G	3/4"
	*If using opening F for other than Safety Valve or Safety Relief Valve, or Safety/Relief valve is larger than 1", Install Safety/Relief Valve in Header Piping as near boiler as possible.		

D249 - Cast Iron Commercial Steam Boiler

Model	Item Number	Type*	Input MBH	Output MBH	Net AHRI Steam PPF	Net AHRI Steam SQ. FT.	Net AHRI Steam MBH	Therm. Eff.	Shp. Wgt. Lbs.	Trade Price
D249-300	CBA030003101103	STD.	300	233	1.33	729	175	77.0%	1000	\$11,617
D249-400	CBA040003101103	STD.	400	310	1.33	971	233	77.0%	1200	\$13,074
D249-500	CBA050003101103	STD.	500	388	1.33	1213	291	77.0%	1400	\$14,531
D249-600	CBA060003101103	STD.	600	465	1.33	1454	349	77.0%	1600	\$18,894
D249-700	CBA070003101103	STD.	700	543	1.33	1696	407	77.0%	1800	\$20,354
D249-800	CBA080003101103	STD.	800	620	1.33	1938	465	77.0%	2000	\$21,869
D249-900	CBA090003101103	STD.	900	698	1.33	2183	524	77.0%	2200	\$23,473
D249-1000	CBA100003101103	STD.	1000	775	1.33	2421	581	77.0%	2400	\$24,917
D249-1100	CBA110003101103	STD.	1100	853	1.33	2667	640	77.0%	2600	\$29,352
D249-1200	CBA120003101103	STD.	1200	930	1.33	2908	698	77.0%	2900	\$30,857
D249-1300	CBA130003101103	STD.	1300	1008	1.33	3150	756	77.0%	3100	\$33,162
D249-1400	CBA140003101103	STD.	1400	1085	1.33	3392	814	77.0%	3300	\$34,621
D249-1500	CBA150003101103	STD.	1500	1163	1.33	3633	872	77.0%	3500	\$36,112
D249-300	CBA030003103103	G.R.S.	300	233	1.33	729	175	77.0%	1000	\$12,971
D249-400	CBA040003103103	G.R.S.	400	310	1.33	971	233	77.0%	1200	\$14,424
D249-500	CBA050003103103	G.R.S.	500	388	1.33	1213	291	77.0%	1400	\$15,883
D249-600	CBA060003103103	G.R.S.	600	465	1.33	1454	349	77.0%	1600	\$21,780
D249-700	CBA070003103103	G.R.S.	700	543	1.33	1696	407	77.0%	1800	\$23,265
D249-800	CBA080003103103	G.R.S.	800	620	1.33	1938	465	77.0%	2000	\$24,724
D249-900	CBA090003103103	G.R.S.	900	698	1.33	2183	524	77.0%	2200	\$26,378
D249-1000	CBA100003103103	G.R.S.	1000	775	1.33	2421	581	77.0%	2400	\$27,829
D249-1100	CBA110003103103	G.R.S.	1100	853	1.33	2667	640	77.0%	2600	\$32,890
D249-1200	CBA120003103103	G.R.S.	1200	930	1.33	2908	698	77.0%	2900	\$34,367
D249-1300	CBA130003103103	G.R.S.	1300	1008	1.33	3150	756	77.0%	3100	\$36,666
D249-1400	CBA140003103103	G.R.S.	1400	1085	1.33	3392	814	77.0%	3300	\$38,132
D249-1500	CBA150003103103	G.R.S.	1500	1163	1.33	3633	872	77.0%	3500	\$39,573
D249-300	CBA030003104103	F.P.R.	300	233	1.33	729	175	77.0%	1000	\$14,361
D249-400	CBA040003104103	F.P.R.	400	310	1.33	971	233	77.0%	1200	\$15,815
D249-500	CBA050003104103	F.P.R.	500	388	1.33	1213	291	77.0%	1400	\$17,271
D249-600	CBA060003104103	F.P.R.	600	465	1.33	1454	349	77.0%	1600	\$23,166
D249-700	CBA070003104103	F.P.R.	700	543	1.33	1696	407	77.0%	1800	\$24,652
D249-800	CBA080003104103	F.P.R.	800	620	1.33	1938	465	77.0%	2000	\$26,122
D249-900	CBA090003104103	F.P.R.	900	698	1.33	2183	524	77.0%	2200	\$27,767
D249-1000	CBA100003104103	F.P.R.	1000	775	1.33	2421	581	77.0%	2400	\$29,219
D249-1100	CBA110003104103	F.P.R.	1100	853	1.33	2667	640	77.0%	2600	\$34,278
D249-1200	CBA120003104103	F.P.R.	1200	930	1.33	2908	698	77.0%	2900	\$35,756
D249-1300	CBA130003104103	F.P.R.	1300	1008	1.33	3150	756	77.0%	3100	\$38,058
D249-1400	CBA140003104103	F.P.R.	1400	1085	1.33	3392	814	77.0%	3300	\$39,520
D249-1500	CBA150003104103	F.P.R.	1500	1163	1.33	3633	872	77.0%	3500	\$40,961

***(STD. - Standard) (G.R.S. - CSD-1 Gravity Return System) (F.P.R. - CSD-1 Boiler Feed Pump Return Control)**

D249 - Knock Down Components & Optional Equipment

Model	Item Number	Description	Trade Price
D249	41154050D	CAST IRON SECTIONS - RIGHT END (179 LBS.)	\$1,307
D249	41154051D	CAST IRON SECTIONS - LEFT END (182 LBS.)	\$1,307
D249	41154052D	CAST IRON SECTIONS - INTERMEDIATE (165 LBS.)	\$1,139
D249-300	550002861D	COMPONENT CARTON - 300	\$3,474
D249-400	550002862D	COMPONENT CARTON - 400	\$3,681
D249-500	550002863D	COMPONENT CARTON - 500	\$3,861
D249-300	550002890D	COMPONENT CARTON - 300 CSD-1	\$4,057
D249-400	550002891D	COMPONENT CARTON - 400 CSD-1	\$4,264
D249-500	550002892D	COMPONENT CARTON - 500 CSD-1	\$4,444
D249	550002871D	END PANEL CARTON - JACKET	\$506
D249	550002860D	END PANEL CARTON - BASE	\$457
D249	41200061D	STEAM TRIM - SA 1 (SIZES/MODELS: 300 - 500)	\$1,698
D249	41200062D	STEAM TRIM - SA 2 (SIZES/MODELS: 600 - 700)	\$1,722
D249	41200063D	STEAM TRIM - SA 3 (SIZES/MODELS: 800 - 1400)	\$1,766
D249	41200064D	STEAM TRIM - SA 4 (SIZES/MODELS: 1500)	\$1,784
D249-300	550002877DS	ACCESSORY CARTON - 300	\$593
D249-400	550002878DS	ACCESSORY CARTON - 400	\$702
D249-500	550002867DS	ACCESSORY CARTON - 500	\$842
D249-600	550002879DS	ACCESSORY CARTON - 600	\$952
D249-700	550002880DS	ACCESSORY CARTON - 700	\$1,067
D249-800	550002881DS	ACCESSORY CARTON - 800	\$1,238
D249-900	550002882DS	ACCESSORY CARTON - 900	\$1,473
D249-1000	550002868DS	ACCESSORY CARTON - 1000	\$1,603
D249-1100	550002883DS	ACCESSORY CARTON - 1100	\$1,832
D249-1200	550002884DS	ACCESSORY CARTON - 1200	\$1,926
D249-1300	550002885DS	ACCESSORY CARTON - 1300	\$2,934
D249-1400	550002886DS	ACCESSORY CARTON - 1400	\$3,051
D249-1500	550002869DS	ACCESSORY CARTON - 1500	\$3,221
D249	41257103D	CSD-1 STEAM TRIM - GRAVITY/CONDENSATE (ALL SIZES)	\$769
D249	41257104D	CSD-1 STEAM TRIM - FEED PUMP (ALL SIZES)	\$2,162
D249-300	550002893DS	CSD-1 ACCESSORY CARTON - 300	\$593
D249-400	550002894DS	CSD-1 ACCESSORY CARTON - 400	\$702
D249-500	550002895DS	CSD-1 ACCESSORY CARTON - 500	\$842
D249-600	550002896DS	CSD-1 ACCESSORY CARTON - 600	\$1,902
D249-700	550002897DS	CSD-1 ACCESSORY CARTON - 700	\$2,045
D249-800	550002898DS	CSD-1 ACCESSORY CARTON - 800	\$2,168
D249-900	550002899DS	CSD-1 ACCESSORY CARTON - 900	\$2,449
D249-1000	550002900DS	CSD-1 ACCESSORY CARTON - 1000	\$2,580
D249-1100	550002901DS	CSD-1 ACCESSORY CARTON - 1100	\$2,809
D249-1200	550002902DS	CSD-1 ACCESSORY CARTON - 1200	\$2,921
D249-1300	550002903DS	CSD-1 ACCESSORY CARTON - 1300	\$3,928
D249-1400	550002904DS	CSD-1 ACCESSORY CARTON - 1400	\$4,045
D249-1500	550002905DS	CSD-1 ACCESSORY CARTON - 1500	\$4,165

D249 (Use Parts Multiplier for All of the Following)

Model	Item Number	Description	Trade Price
D249	14662311	STEAM MANUAL RESET PRESSURE CONTROL (L4079B1033)	\$368
D249	1280001	M-M 47-2 LWCO & FEEDER (MODELS 300-1500)	\$1,651
D249	14662313	STRAP ON OPERATING CONTROL (L6006C-1034)	\$222
D249	240007388	LWCO, MAN RESET, CSD-1 APPROVED, SHT PROBE	\$292

D249 - Standard Equipment

Standard Equipment:

(67 Low Water Cut-Off, PA404A Pressuretrol and Syphon Loop, Water Gauge Glass Set with Glass and Rods, Steam Gauge, Pop Safety Valve).

CSD-1 Control Requirements

The optional CSD-1 controls modify the standard D249 boiler on both the fuel train and the steam trim as follows:

Steam Boiler with Boiler Feed Pump Return System

- Add SF-500 Hydrolevel Safeguard Manual Reset L.W.C.O.
- Add 150S-B-MD L.W.C.O. and Pump Control
- Delete 67D-1 L.W.C.O.
- Add L404L Manual Reset Pressure Control

Steam Boiler with Gravity or Condensate Pump Return

- Add SF-500 Hydrolevel Safeguard Manual Reset L.W.C.O.
- Add L404C Manual Reset Pressure Control

The SF-500 L.W.C.O. is the secondary L.W.C.O. to the 67D-1 L.W.C.O. furnished standard with the boiler.

Fuel Train

Substitute CSD-1 fuel train(s) for standard which includes (per base): Intermittent Pilot Module (PT#1140007) control Stop w/alarm 1003-612A & (PT#1140008) Control CSD1 Lockout Board BD 1145-2 with manual reset; Independent Pilot Gas Line (Manual shut-off valve, Pressure regulator, Safety shut-off valve); Main Gas Line (Gas Valve, Two leak test cocks, Manual shut-off downstream of the main gas valve).

Notes:

1. The D249-300 and D249-400 do not require fuel train modifications for CSD-1. The standard fuel train is furnished.
2. Control equipment is included to meet Dunkirk's interpretation of CSD-1. Consult local authorities before the installation of the boiler. Additional controls, if required can be provided at an additional price.

EXCELSIOR EXB Cast Iron 3-Pass Oil Boilers

- MBH Input 105 - 252
- Up to 87% AFUE, ENERGY STAR® Certified Models
- Advanced High Efficiency 3-Pass Heat Exchanger Design
- High Limit Control with:
 - LED display
 - Easy to program dial settings
 - Boiler Water Temperature Reset
 - Low Water Cut Off (LWCO)
- Compact Footprint
- Burners and Venting Options (Burner cover standard)
- Easy Serviceability



General Information (See IOM for Complete Instructions)				
Model	EXB4	EXB5	EXB6	EXB7
Water Return/Supply	1 1/4" NPT			
Drain Valve	3/4" NPT			
Electrical	120 Volts AC, 60 hertz, 1 phase, less than 12 amps (15 amp circuit recommended)			
Water Content (Gallons)	3.6	4.3	5.1	5.9
Dimensions	A-Height	31"	31"	31"
	B-Width	17 3/4"	17 3/4"	17 3/4"
	C-Depth	18 3/8"	21 5/8"	24 7/8"

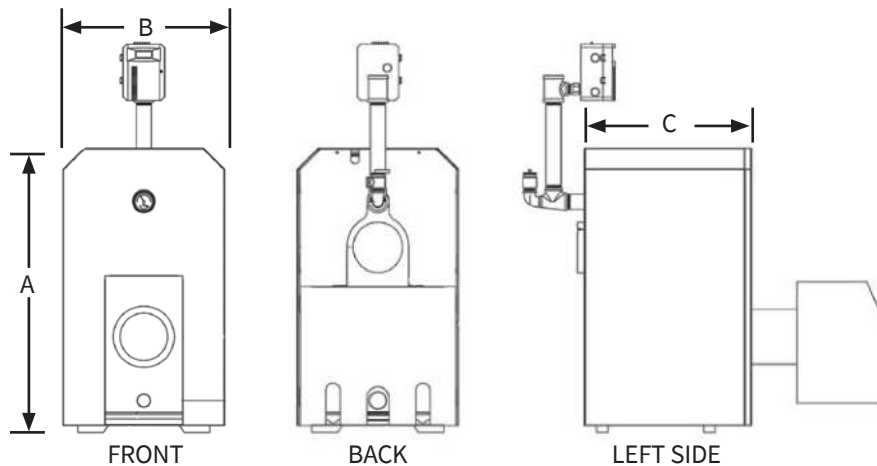

DHW MODULE Domestic Hot Water Module (Sold Separately)

- The Domestic Hot Water (DHW) Module is a great way to make domestic hot water using an existing boiler
- Digital control has the ability to set a consistent DHW temperature from 108°F - 140°F
- Brazed plate stainless steel heat exchanger offers lower pressure drop than tankless water coils with nearly 100% heat transfer efficiency
- Simple and flexible installation - mounts on a wall near the boiler as an additional heating zone
- Compact design with insulated cover and a standard 120 volt power cord
- Easy to service and clean

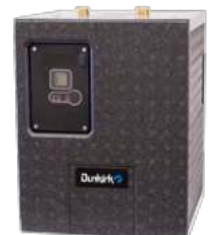

EXCELSIOR EXB - Cast Iron 3-Pass Oil Boiler

Model	Item Number	Input MBH	Htg. Cap. MBH	AHRI Net MBH	AFUE	Fuel	Burner	Pump	Shp. Wgt. lbs	Trade Price
EXB4075	EXB407530200303	105	92	80	87.0%	OIL	BECKETT	LESS	436	\$3,523
EXB4090	EXB409030200303	126	110	96	86.0%	OIL	BECKETT	LESS	436	\$3,523
EXB5100	EXB510030200303	140	123	107	87.0%	OIL	BECKETT	LESS	496	\$4,013
EXB5120	EXB512030200303	168	148	129	86.0%	OIL	BECKETT	LESS	496	\$4,013
EXB6130	EXB613030200303	182	160	139	87.0%	OIL	BECKETT	LESS	560	\$4,234
EXB6145	EXB614530200303	203	178	155	86.0%	OIL	BECKETT	LESS	560	\$4,234
EXB7165	EXB716530200303	231	202	176	87.0%	OIL	BECKETT	LESS	620	\$4,830
EXB7180	EXB718030200303	252	220	191	86.0%	OIL	BECKETT	LESS	620	\$4,830
EXB4075	EXB407530240303	105	92	80	87.0%	OIL	BECKETT	TACO ECM	436	\$3,628
EXB4090	EXB409030240303	126	110	96	86.0%	OIL	BECKETT	TACO ECM	436	\$3,628
EXB5100	EXB510030240303	140	123	107	87.0%	OIL	BECKETT	TACO ECM	496	\$4,122
EXB5120	EXB512030240303	168	148	129	86.0%	OIL	BECKETT	TACO ECM	496	\$4,122
EXB6130	EXB613030240303	182	160	139	87.0%	OIL	BECKETT	TACO ECM	560	\$4,342
EXB6145	EXB614530240303	203	178	155	86.0%	OIL	BECKETT	TACO ECM	560	\$4,342
EXB7165	EXB716530240303	231	202	176	87.0%	OIL	BECKETT	TACO ECM	620	\$4,940
EXB7180	EXB718030240303	252	220	191	86.0%	OIL	BECKETT	TACO ECM	620	\$4,940
EXB4075	EXB407530220303	105	92	80	87.0%	OIL	BECKETT	GRUNDFOS	436	\$3,628
EXB4090	EXB409030220303	126	110	96	86.0%	OIL	BECKETT	GRUNDFOS	436	\$3,628
EXB5100	EXB510030220303	140	123	107	87.0%	OIL	BECKETT	GRUNDFOS	496	\$4,122
EXB5120	EXB512030220303	168	148	129	86.0%	OIL	BECKETT	GRUNDFOS	496	\$4,122
EXB6130	EXB613030220303	182	160	139	87.0%	OIL	BECKETT	GRUNDFOS	560	\$4,342
EXB6145	EXB614530220303	203	178	155	86.0%	OIL	BECKETT	GRUNDFOS	560	\$4,342
EXB7165	EXB716530220303	231	202	176	87.0%	OIL	BECKETT	GRUNDFOS	620	\$4,940
EXB7180	EXB718030220303	252	220	191	86.0%	OIL	BECKETT	GRUNDFOS	620	\$4,940
EXB4075	EXB407550200303	105	92	80	87.0%	OIL	RIELLO	LESS	436	\$3,617
EXB4090	EXB409050200303	126	110	96	86.0%	OIL	RIELLO	LESS	436	\$3,617
EXB5100	EXB510050200303	140	123	107	87.0%	OIL	RIELLO	LESS	496	\$4,171
EXB5120	EXB512050200303	168	148	129	86.0%	OIL	RIELLO	LESS	496	\$4,171
EXB6130	EXB613050200303	182	160	139	87.0%	OIL	RIELLO	LESS	560	\$4,390
EXB6145	EXB614550200303	203	178	155	86.0%	OIL	RIELLO	LESS	560	\$4,390
EXB7165	EXB716550200303	231	202	176	87.0%	OIL	RIELLO	LESS	620	\$4,910
EXB7180	EXB718050200303	252	220	191	86.0%	OIL	RIELLO	LESS	620	\$4,910
EXB4075	EXB407550240303	105	92	80	87.0%	OIL	RIELLO	TACO ECM	436	\$3,726
EXB4090	EXB409050240303	126	110	96	86.0%	OIL	RIELLO	TACO ECM	436	\$3,726
EXB5100	EXB510050240303	140	123	107	87.0%	OIL	RIELLO	TACO ECM	496	\$4,282
EXB5120	EXB512050240303	168	148	129	86.0%	OIL	RIELLO	TACO ECM	496	\$4,282
EXB6130	EXB613050240303	182	160	139	87.0%	OIL	RIELLO	TACO ECM	560	\$4,501
EXB6145	EXB614550240303	203	178	155	86.0%	OIL	RIELLO	TACO ECM	560	\$4,501
EXB7165	EXB716550240303	231	198	172	87.0%	OIL	RIELLO	TACO ECM	560	\$5,020
EXB7180	EXB718050240303	252	220	191	86.0%	OIL	RIELLO	TACO ECM	620	\$5,020

EXCELSIOR EXB - Cast Iron 3-Pass Oil Boiler - Continued

Model	Item Number	Input MBH	Htg. Cap. MBH	AHRI Net MBH	AFUE	Fuel	Burner	Pump	Shp. Wgt. lbs	Trade Price
EXB4075	EXB407550220303	105	92	80	87.0%	OIL	RIELLO	GRUNDFOS	436	\$3,726
EXB4090	EXB409050220303	126	110	96	86.0%	OIL	RIELLO	GRUNDFOS	436	\$3,726
EXB5100	EXB510050220303	140	123	107	87.0%	OIL	RIELLO	GRUNDFOS	496	\$4,282
EXB5120	EXB512050220303	168	148	129	86.0%	OIL	RIELLO	GRUNDFOS	496	\$4,282
EXB6130	EXB613050220303	182	160	139	87.0%	OIL	RIELLO	GRUNDFOS	560	\$4,501
EXB6145	EXB614550220303	203	178	155	86.0%	OIL	RIELLO	GRUNDFOS	560	\$4,501
EXB7165	EXB716550220303	231	202	176	87.0%	OIL	RIELLO	GRUNDFOS	620	\$5,020
EXB7180	EXB718050220303	252	220	191	86.0%	OIL	RIELLO	GRUNDFOS	620	\$5,020
EXB4090	EXB409020240303	126	110	96	86.0%	OIL	LESS	TACO ECM	436	\$2,686
EXB5120	EXB512020240303	168	148	129	86.0%	OIL	LESS	TACO ECM	496	\$3,131
EXB6145	EXB614520240303	203	178	155	86.0%	OIL	LESS	TACO ECM	560	\$3,439
EXB7180	EXB718020240303	252	220	191	86.0%	OIL	LESS	TACO ECM	620	\$3,961
EXB4090	EXB409020220303	126	110	96	86.0%	OIL	LESS	GRUNDFOS	436	\$2,686
EXB5120	EXB512020220303	168	148	129	86.0%	OIL	LESS	GRUNDFOS	496	\$3,131
EXB6145	EXB614520220303	203	178	155	86.0%	OIL	LESS	GRUNDFOS	560	\$3,439
EXB7180	EXB718020220303	252	220	191	86.0%	OIL	LESS	GRUNDFOS	620	\$3,961
EXB4090	EXB409020200303	126	110	96	86.0%	OIL	LESS	LESS	436	\$2,579
EXB5120	EXB512020200303	168	148	129	86.0%	OIL	LESS	LESS	496	\$3,020
EXB6145	EXB614520200303	203	178	155	86.0%	OIL	LESS	LESS	560	\$3,330
EXB7180	EXB718020200303	252	220	191	86.0%	OIL	LESS	LESS	620	\$3,850

EXCELSIOR EXB - Venting Options & Additional Equipment

Model	Item Number	Description	Trade Price
EXB	29231D	36" RISER TERMINATION	\$1,527
EXB	28972D	STANDARD TERMINATION	\$651
EXB	550004240U	4" ID X 10 FT DIRECT VENT PIPE KIT (SELECT TERMINATION)	\$851
EXB	550004241U	4" ID X 15 FT DIRECT VENT PIPE KIT (SELECT TERMINATION)	\$1,020
EXB	550004242U	4" ID X 20 FT DIRECT VENT PIPE KIT (SELECT TERMINATION)	\$1,202

EXCELSIOR EXB - Replacement Oil Burners

EXB4075	240007232D	BECKETT CHIMNEY VENT W/O COVER MODEL AFG	\$846
EXB4090	240013303D	BECKETT CHIMNEY VENT W/O COVER MODEL AFG	\$846
EXB5100	240013393D	BECKETT CHIMNEY VENT W/O COVER MODEL AFG	\$949
EXB5120	240013395D	BECKETT CHIIMNEY VENT W/O COVER MODEL AFG	\$949
EXB6130	240013397D	BECKETT CHIMNEY VENT W/O COVER MODEL AFG	\$949
EXB6145	240013399D	BECKETT CHIMNEY VENT W/O COVER MDEL AFG	\$949
EXB7165	240013401D	BECKETT CHIMNEY VENT W/O COVER MODEL AFG	\$949
EXB7180	240013403D	BECKETT CHIMNEY VENT W/O COVER MODEL AFG	\$1,066
EXB4075	240007144D	BECKETT CHIMNEY VENT WITH COVER MODEL AFG	\$906
EXB4090	240013302D	BECKETT CHIMNEY VENT WITH COVER MODEL AFG	\$906
EXB5100	240013394D	BECKETT CHIMNEY VENT WITH COVER MODEL AFG	\$1,010
EXB5120	240013396D	BECKETT CHIMNEY VENT WITH COVER MODEL AFG	\$1,010
EXB6130	240013398D	BECKETT CHIMNEY VENT WITH COVER MODEL AFG	\$1,010
EXB6145	240013400D	BECKETT CHIMNEY VENT WITH COVER MODEL AFG	\$1,010
EXB7165	240013402D	BECKETT CHIMNEY VENT WITH COVER MODEL AFG	\$1,010
EXB7180	240013404D	BECKETT CHIMNEY VENT WITH COVER MODEL AFG	\$1,010

EXCELSIOR EXB - Replacement Oil Burners - Continued

Model	Item Number	Description	Trade Price
EXB4075	550004238D	BECKETT DIRECT VENT MODEL NX	\$1,081
EXB5100	240007532D	BECKETT DIRECT VENT MODEL NX	\$1,126
EXB6130	240007533D	BECKETT DIRECT VENT MODEL NX	\$1,043
EXB4075	550003548D	RIELLO CHIMNEY VENT MODEL 40F5	\$1,000
EXB4090	550004237D	RIELLO CHIMNEY VENT MODEL 40F5	\$1,000
EXB5100	550004287D	RIELLO CHIMNEY VENT MODEL 40F5	\$1,000
EXB5120	550004290D	RIELLO CHIMNEY VENT MODEL 40F5	\$1,000
EXB6130	550004288D	RIELLO CHIMNEY VENT MODEL 40F5	\$1,000
EXB6145	550004291D	RIELLO CHIMNEY VENT MODEL 40F5	\$1,000
EXB7165	550004289D	RIELLO CHIMNEY VENT MODEL 40F10	\$1,267
EXB7180	550004292D	RIELLO CHIMNEY VENT MODEL 40F10	\$1,267
EXB4075	550004239D	RIELLO DIRECT VENT MODEL 40BF	\$1,458
EXB5100	550003563D	RIELLO DIRECT VENT MODEL 40BF	\$1,566
EXB6130	550003566D	RIELLO DIRECT VENT MODEL 40BF	\$1,479
EXB4	240013299D	CARLIN CHIMNEY VENT MODEL EZ-LF (4075 & 4090)	\$914
EXB5	240013406D	CARLIN CHIMNEY VENT MODEL EZ-LF (5100 & 5120)	\$1,014
EXB6	240013408D	CARLIN CHIMNEY VENT MODEL EZ-LF (6130 & 6145)	\$1,014
EXCELSIOR EXB (Use Parts Multiplier for All of the Following)			
EXB	550001929	KIT, HIGH LIMIT MANUAL RESET L4006E1109 WITH PLUG IN HARNESS	\$306
EXB	14624002	FILL-TROL FOR WATER BOILERS 150 MBH OR LESS	\$401
EXB	14624003	FILL-TROL FOR WATER BOILERS OVER 150 MBH	\$557

DHW Module

Model	Item Number	Description	Trade Price
550003792	550003792D	DOMESTIC HOT WATER MODULE	\$1,127

EMPIRE EWC Cast Iron Chimney Vented Oil Boilers

- MBH Input 112 - 217 (CH)
- Up to 86.2% AFUE
- Cast Iron Heat Exchanger with Cast Iron Push Nipples
- Swing out Burner Door
- Hydrolevel Operating Control
 - Digital display and diagnostics
 - Adjusts water temperature based on your heating system demand
 - Built-in Low Water Cut Off (LWCO)
- Optional Tankless Domestic Water Heater Coil



General Information (See IOM for Complete Instructions)			
Model	3EWC	4EWC	5EWC
Water Return/Supply	1 1/4" NPT		
Optional Tankless Coil	1/2" NPT		
Electrical	120 Volts AC, 60 hertz, 1 phase, less than 12 amps (15 amp circuit recommended)		
Water Content (Gallons)	9.6	11.6	13.7
Dimensions	A-Height	36"	36"
	B-Width	20 1/2"	20 1/2"
	C-Depth	14 1/2"	17 3/4"

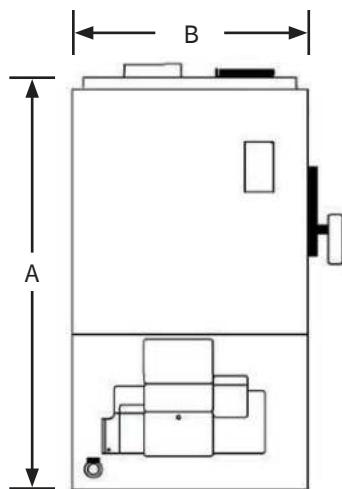

FRONT

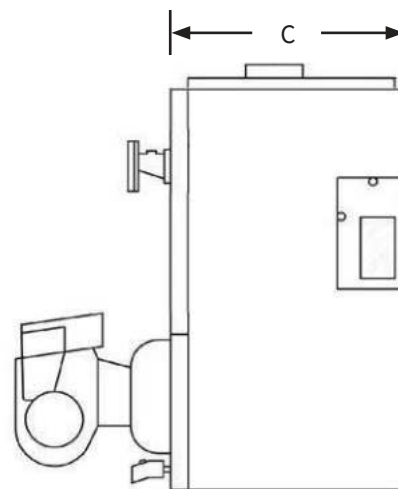

RIGHT SIDE

EMPIRE EWC - Cast Iron Chimney Vent Oil Boiler

Model	Item Number	Type	Input MBH	Htg. Cap. MBH	AHRI Net MBH	AFUE	Burner	Pump	Fire Rate GPH	Coil GPM	Shp. Wgt. lbs	Trade Price
3EWC0.80	EWC308031200103	LESS	112	98	85	86.0%	BECKETT	LESS	0.80	N/A	470	\$3,894
4EWC1.00	EWC410031200103	LESS	140	122	106	86.2%	BECKETT	LESS	1.00	N/A	545	\$4,115
4EWC1.25	EWC412531200103	LESS	175	152	132	86.0%	BECKETT	LESS	1.25	N/A	545	\$4,115
5EWC1.35	EWC513531200103	LESS	189	167	145	86.0%	BECKETT	LESS	1.35	N/A	630	\$5,716
5EWC1.55	EWC515531200103	LESS	217	189	164	86.0%	BECKETT	LESS	1.55	N/A	630	\$5,716
3EWC0.80T	EWC308032200103	COIL	112	98	85	86.0%	BECKETT	LESS	0.80	3.05	470	\$4,584
4EWC1.00T	EWC410032200103	COIL	140	122	106	86.2%	BECKETT	LESS	1.00	3.25	545	\$4,803
4EWC1.25T	EWC412532200103	COIL	175	152	132	86.0%	BECKETT	LESS	1.25	3.50	545	\$4,803
5EWC1.35T	EWC513532200103	COIL	189	167	145	86.0%	BECKETT	LESS	1.35	3.60	630	\$6,398
5EWC1.55T	EWC515532200103	COIL	217	189	164	86.0%	BECKETT	LESS	1.55	3.80	630	\$6,398
3EWC0.80	EWC308031240103	LESS	112	98	85	86.0%	BECKETT	TACO ECM	0.80	N/A	470	\$3,951
4EWC1.00	EWC410031240103	LESS	140	122	106	86.2%	BECKETT	TACO ECM	1.00	N/A	545	\$4,171
4EWC1.25	EWC412531240103	LESS	175	152	132	86.0%	BECKETT	TACO ECM	1.25	N/A	545	\$4,171
5EWC1.35	EWC513531240103	LESS	189	167	145	86.0%	BECKETT	TACO ECM	1.35	N/A	630	\$5,773
5EWC1.55	EWC515531240103	LESS	217	189	164	86.0%	BECKETT	TACO ECM	1.55	N/A	630	\$5,773
3EWC0.80T	EWC308032240103	COIL	112	98	85	86.0%	BECKETT	TACO ECM	0.80	3.05	470	\$4,640
4EWC1.00T	EWC410032240103	COIL	140	122	106	86.2%	BECKETT	TACO ECM	1.00	3.25	545	\$4,859
4EWC1.25T	EWC412532240103	COIL	175	152	132	86.0%	BECKETT	TACO ECM	1.25	3.50	545	\$4,859
5EWC1.35T	EWC513532240103	COIL	189	167	145	86.0%	BECKETT	TACO ECM	1.35	3.60	630	\$6,455
5EWC1.55T	EWC515532240103	COIL	217	189	164	86.0%	BECKETT	TACO ECM	1.55	3.80	630	\$6,455
3EWC0.80	EWC308031220103	LESS	112	98	85	86.0%	BECKETT	GRUNDFOS	0.80	N/A	470	\$3,951
4EWC1.00	EWC410031220103	LESS	140	122	106	86.2%	BECKETT	GRUNDFOS	1.00	N/A	545	\$4,171
4EWC1.25	EWC412531220103	LESS	175	152	132	86.0%	BECKETT	GRUNDFOS	1.25	N/A	545	\$4,171
5EWC1.35	EWC513531220103	LESS	189	167	145	86.0%	BECKETT	GRUNDFOS	1.35	N/A	630	\$5,773
5EWC1.55	EWC515531220103	LESS	217	189	164	86.0%	BECKETT	GRUNDFOS	1.55	N/A	630	\$5,773
3EWC0.80T	EWC308032220103	COIL	112	98	85	86.0%	BECKETT	GRUNDFOS	0.80	3.05	470	\$4,640
4EWC1.00T	EWC410032220103	COIL	140	122	106	86.2%	BECKETT	GRUNDFOS	1.00	3.25	545	\$4,859
4EWC1.25T	EWC412532220103	COIL	175	152	132	86.0%	BECKETT	GRUNDFOS	1.25	3.50	545	\$4,859
5EWC1.35T	EWC513532220103	COIL	189	167	145	86.0%	BECKETT	GRUNDFOS	1.35	3.60	630	\$6,455
5EWC1.55T	EWC515532220103	COIL	217	189	164	86.0%	BECKETT	GRUNDFOS	1.55	3.80	630	\$6,455
3EWC0.80	EWC308031230103	LESS	112	98	85	86.0%	BECKETT	B&G	0.80	N/A	470	\$3,951
4EWC1.00	EWC410031230103	LESS	140	122	106	86.2%	BECKETT	B&G	1.00	N/A	545	\$4,171
4EWC1.25	EWC412531230103	LESS	175	152	132	86.0%	BECKETT	B&G	1.25	N/A	545	\$4,171
5EWC1.35	EWC513531230103	LESS	189	167	145	86.0%	BECKETT	B&G	1.35	N/A	630	\$5,773
5EWC1.55	EWC515531230103	LESS	217	189	164	86.0%	BECKETT	B&G	1.55	N/A	630	\$5,773
3EWC0.80T	EWC308032230103	COIL	112	98	85	86.0%	BECKETT	B&G	0.80	3.05	470	\$4,640
4EWC1.00T	EWC410032230103	COIL	140	122	106	86.2%	BECKETT	B&G	1.00	3.25	545	\$4,859
4EWC1.25T	EWC412532230103	COIL	175	152	132	86.0%	BECKETT	B&G	1.25	3.50	545	\$4,859
5EWC1.35T	EWC513532230103	COIL	189	167	145	86.0%	BECKETT	B&G	1.35	3.60	630	\$6,455
5EWC1.55T	EWC515532230103	COIL	217	189	164	86.0%	BECKETT	B&G	1.55	3.80	630	\$6,455
3EWC0.80	EWC308051240103	LESS	112	98	85	86.0%	RIELLO	TACO ECM	0.80	3.05	470	\$4,143
4EWC1.00	EWC410051240103	LESS	140	122	106	86.2%	RIELLO	TACO ECM	1.00	3.25	545	\$4,363
4EWC1.25	EWC412551240103	LESS	175	152	132	86.0%	RIELLO	TACO ECM	1.25	3.50	545	\$4,363
5EWC1.35	EWC513551240103	LESS	189	167	145	86.0%	RIELLO	TACO ECM	1.35	3.60	630	\$5,963
5EWC1.55	EWC515551240103	LESS	217	189	164	86.0%	RIELLO	TACO ECM	1.55	3.80	630	\$5,963

EMPIRE EWC - Cast Iron Chimney Vent Oil Boiler - Continued

Model	Item Number	Type	Input MBH	Htg. Cap. MBH	AHRI Net MBH	AFUE	Burner	Pump	Fire Rate GPH	Coil GPM	Shp. Wgt. lbs	Trade Price
3EWC0.80T	EWC308052240103	COIL	112	98	85	86.0%	RIELLO	TACO ECM	0.80	3.05	470	\$4,825
4EWC1.00T	EWC410052240103	COIL	140	122	106	86.2%	RIELLO	TACO ECM	1.00	3.25	545	\$5,046
4EWC1.25T	EWC412552240103	COIL	175	152	132	86.0%	RIELLO	TACO ECM	1.25	3.50	545	\$5,046
5EWC1.35T	EWC513552240103	COIL	189	167	145	86.0%	RIELLO	TACO ECM	1.35	3.60	630	\$7,112
5EWC1.55T	EWC515552240103	COIL	217	189	164	86.0%	RIELLO	TACO ECM	1.55	3.80	630	\$7,112
3EWC0.80	EWC308071240103	LESS	112	98	85	86.0%	CARLIN	TACO ECM	0.80	3.05	470	\$3,951
4EWC1.00	EWC410071240103	LESS	140	122	106	86.2%	CARLIN	TACO ECM	1.00	3.25	545	\$4,171
4EWC1.25	EWC412571240103	LESS	175	152	132	86.0%	CARLIN	TACO ECM	1.25	3.50	545	\$4,171
5EWC1.35	EWC513571240103	LESS	189	167	145	86.0%	CARLIN	TACO ECM	1.35	3.60	630	\$5,773
5EWC1.55	EWC515571240103	LESS	217	189	164	86.0%	CARLIN	TACO ECM	1.55	3.80	630	\$5,773
3EWC0.80T	EWC308072240103	COIL	112	98	85	86.0%	CARLIN	TACO ECM	0.80	3.05	470	\$4,640
4EWC1.00T	EWC410072240103	COIL	140	122	106	86.2%	CARLIN	TACO ECM	1.00	3.25	545	\$4,859
4EWC1.25T	EWC412572240103	COIL	175	152	132	86.0%	CARLIN	TACO ECM	1.25	3.50	545	\$4,859
5EWC1.35T	EWC513572240103	COIL	189	167	145	86.0%	CARLIN	TACO ECM	1.35	3.60	630	\$6,455
5EWC1.55T	EWC515572240103	COIL	217	189	164	86.0%	CARLIN	TACO ECM	1.55	3.80	630	\$6,455
3EWC0.80	EWC308021200103	LESS	112	98	85	86.0%	LESS	LESS	0.80	N/A	470	\$2,952
4EWC1.25	EWC412521200103	LESS	175	152	132	86.0%	LESS	LESS	1.25	N/A	545	\$3,173
5EWC1.35	EWC513521200103	LESS	189	167	145	86.0%	LESS	LESS	1.35	N/A	630	\$4,717
5EWC1.55	EWC515521200103	LESS	217	189	164	86.0%	LESS	LESS	1.55	N/A	630	\$4,717
3EWC0.80T	EWC308022200103	COIL	112	98	85	86.0%	LESS	LESS	0.80	3.05	470	\$3,641
4EWC1.25T	EWC412522200103	COIL	175	152	132	86.0%	LESS	LESS	1.25	3.50	545	\$3,860
5EWC1.35T	EWC513522200103	COIL	189	167	145	86.0%	LESS	LESS	1.35	3.60	630	\$5,398
5EWC1.55T	EWC515522200103	COIL	217	189	164	86.0%	LESS	LESS	1.55	3.80	630	\$5,398
3EWC0.80	EWC308021240103	LESS	112	98	85	86.0%	LESS	TACO ECM	0.80	N/A	470	\$3,048
4EWC1.25	EWC412521240103	LESS	175	152	132	86.0%	LESS	TACO ECM	1.25	N/A	545	\$3,268
5EWC1.35	EWC513521240103	LESS	189	167	145	86.0%	LESS	TACO ECM	1.35	N/A	630	\$4,870
5EWC1.55	EWC515521240103	LESS	217	189	164	86.0%	LESS	TACO ECM	1.55	N/A	630	\$4,870
3EWC0.80T	EWC308022240103	COIL	112	98	85	86.0%	LESS	TACO ECM	0.80	3.05	470	\$3,737
4EWC1.25T	EWC412522240103	COIL	175	152	132	86.0%	LESS	TACO ECM	1.25	3.50	545	\$3,956
5EWC1.35T	EWC513522240103	COIL	189	167	145	86.0%	LESS	TACO ECM	1.35	3.60	630	\$5,551
5EWC1.55T	EWC515522240103	COIL	217	189	164	86.0%	LESS	TACO ECM	1.55	3.80	630	\$5,551
3EWC0.80	EWC308021220103	LESS	112	98	85	86.0%	LESS	GRUNDFOS	0.80	N/A	470	\$3,048
4EWC1.25	EWC412521220103	LESS	175	152	132	86.0%	LESS	GRUNDFOS	1.25	N/A	545	\$3,268
5EWC1.35	EWC513521220103	LESS	189	167	145	86.0%	LESS	GRUNDFOS	1.35	N/A	630	\$4,870
5EWC1.55	EWC515521220103	LESS	217	189	164	86.0%	LESS	GRUNDFOS	1.55	N/A	630	\$4,870
3EWC0.80T	EWC308022220103	COIL	112	98	85	86.0%	LESS	GRUNDFOS	0.80	3.05	470	\$3,737
4EWC1.25T	EWC412522220103	COIL	175	152	132	86.0%	LESS	GRUNDFOS	1.25	3.50	545	\$3,956
5EWC1.35T	EWC513522220103	COIL	189	167	145	86.0%	LESS	GRUNDFOS	1.35	3.60	630	\$5,551
5EWC1.55T	EWC515522220103	COIL	217	189	164	86.0%	LESS	GRUNDFOS	1.55	3.80	630	\$5,551

EMPIRE EWC - BURNERS			
Model	Item Number	Description	Trade Price
EWC	550003929	RIELLO BURNER (3/4/5 SECTION)^	\$927
EWC	550004306	RIELLO BURNER (5EWC1.35)^	\$927
EWC	550003928	CARLIN EZ-1 BURNER (3/4/5 SECTION)^	\$903
EWC	550003927	BECKETT EWC AFG (3 SECTION)	\$903
EWC	550003960	BECKETT EWC AFG (4/5 SECTION)^	\$903
EWC	550004305	BECKETT EWC AFG (5EWC1.35)^	\$903

^BURNER-IN-BOX Requires Additional Purchase of Rerate Kit from List Below

EMPIRE EWC (Use Parts Multiplier for All of the Following)			
Model	Item Number	Description	Trade Price
EWC	550004243	4 SECTION BECKETT BURNER RE-RATE KIT, 1.25 TO 1.00	\$82
EWC	550004244	4 SECTION BECKETT BURNER RE-RATE KIT, 1.00 TO 1.25	\$82
EWC	550004245	4 SECTION RIELLO, CARLIN, BURNER RE-RATE KIT, 1.25 TO 1.00	\$82
EWC	550004246	4 SECTION RIELLO BURNER RE-RATE KIT, 1.00 TO 1.25	\$82
EWC	550004247	4 SECTION CARLIN BURNER RE-RATE KIT, 1.00 TO 1.25	\$82
EWC	550004307	5 SECTION BECKETT, CARLIN, RIELLO BURNER RE-RATE KIT, 1.55 TO 1.35	\$32
EWC	550004308	5 SECTION BECKETT, CARLIN, RIELLO BURNER RE-RATE KIT, 1.35 TO 1.55	\$32
EWC	14624002	FILL-TROL #110 FOR WATER BOILERS 150 MBH OR LESS	\$401
EWC	14624003	FILL-TROL #111 FOR WATER BOILERS OVER 150 MBH	\$557

SBO Cast Iron Steam Oil Boilers

- MBH Input 119 - 210 (CH)
- Up to 85.6% AFUE
- Dependable Cast Iron Heat Exchanger
- Cast Iron Swing out Burner Door and large flueways allow for easy cleaning and servicing
- Honeywell Pressure Control, Boiler Water Level Gauge Glass, and Steam Pressure Gauge
- Electronic Low Water Cutoff (LWCO)
- Atmospheric Chimney Vent Boiler



General Information (See IOM for Complete Instructions)				
Model	SBO-3085	SBO-3105	SBO-4125	SBO-4150
Return/Supply Tappings	1 1/4" Return NPT, 2" Supply NPT			
Oil	3/8" O.D. Copper (runs 50' or less, 1/2" O.D. Copper (runs over 50')			
Electrical	120 Volts AC, 60 hertz, 1 phase, less than 12 amps (15 amp circuit recommended)			
Water Content (Gallons)	12	12	14.87	14.87
Dimensions	A-Height	35"	35"	35"
	B-Width	22 1/8"	22 1/8"	22 1/8"
	C-Depth	15 3/4"	15 3/4"	19 3/4"

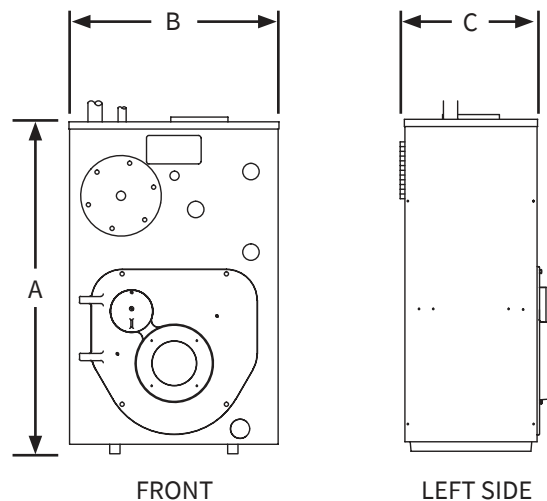

SBO - Cast Iron Steam Oil Boiler Less Burner

Model	Item Number	Type	Input MBH	Htg. Cap. MBH	AHRI Net MBH	AHRI Net Sq. Ft. Steam	AFUE	Burner	Firing Rate GPH	Shp. Wgt. lbs	Trade Price
SBO-3105	SBO310521700103	LESS	147	127	95	396	85.0%	LESS	1.05	538	\$3,913
SBO-4150	SBO415021700103	LESS	210	180	135	563	85.0%	LESS	1.50	650	\$4,598

SBO (Use Equipment Multiplier for All of the Following)

Model	Item Number	Description	Trade Price
SBO	550004158D	TANKLESS COIL KIT WITH CONTROL	\$541
SBO-3105	550004153D	SBO-3105 BECKETT BURNER IN A BOX KIT	\$891
SBO-4150	550004154D	SBO-4150 BECKETT BURNER IN A BOX KIT	\$891

Please Note: Oil Fired Steam Boilers are sold less burner. Please add burner in a box kit to your order.

Tankless Coil Kits are sold separately.

SBO (Use Parts Multiplier for All of the Following)

Model	Item Number	Description	Trade Price
SBO	550004155	3085/3105 BECKETT RERATE KIT	\$158
SBO	550004156	4125/4150 BECKETT RERATE KIT	\$158

H2O GL Single Coil Glass Lined Indirect Water Heaters

- 31 - 106 Gallon Capacities
- Easy to Install
- Low Pressure Drop
- Magnesium Anode Rod Corrosion Protection
- Enameled Coated Steel Tank and Coil
- Minimal Standby Losses
- Flexible Scratch Resistant Jacket
- Aquastat Sensor Well
- Temperature Pressure Relief Valve



(H2O40GL Model Shown)

General Information (See IOM for Complete Instructions)					
Maximum Working Pressure: 150 psi for all Capacities					
Model	Piping Connections NPT		Dimensions		
	Domestic Water In/Out	Boiler Water In/Out	Diameter	Height	Weight
H2O 30 GL	1"	1"	24"	33"	119 lbs
H2O 40 GL	1"	1"	24"	45"	180 lbs
H2O 50 GL	1"	1"	24"	51"	200 lbs
H2O 80 GL	1"	1"	30"	48"	243 lbs
H2O 105 GL	1"	1"	30"	62"	393 lbs

H2O GL - Single Coil Glass Lined Indirect Water Heaters

Model	Item Number	Storage Capacity gal	Type	Max. First Hour Rating gal/hr @	Continuous Rating gal/hr @	Boiler Output Req. BTU/hr	Shp. Wgt. lbs	Trade Price
H2O 30 GL	H2OIG30DK	31	GLASS LINED	155	124	100,000	119	\$1,345
H2O 40 GL	H2OIG40DK	42	GLASS LINED	256	220	120,000	180	\$1,383
H2O 50 GL	H2OIG50DK	53	GLASS LINED	310	268	140,000	200	\$1,577
H2O 80 GL	H2OIG80DK	79	GLASS LINED	346	281	180,000	243	\$2,185
H2O 105 GL	H2OIG105DK	106	GLASS LINED	440	345	220,000	393	\$3,421

H2O GL (Use Parts Multiplier for All of the Following)

Model	Item Number	Description	Trade Price
30-105 GAL.	240010926	T & P VALVE 3/4, 100XL-8	\$59
30-105 GAL.	AQ-020.01	AQUASTAT WELL	\$41
30-105 GAL.	240013432	AQUASTAT	\$163
30-50 GAL.	240012211	PLASTIC TOP CAP	\$32
80-105 GAL.	240012239	PLASTIC TOP CAP	\$45
40-105 GAL.	240012212	PLASTIC FRONT CAP	\$8
30 GAL.	550003640	ANODE KIT MAGNESIUM (INCLUDES ANODE, GASKET & BUSHING)	\$43
40-50 GAL.	550003505	ANODE KIT MAGNESIUM (INCLUDES ANODE, GASKET & BUSHING)	\$43
80-105 GAL.	550003527	ANODE KIT MAGNESIUM (INCLUDES ANODE, GASKET & BUSHING)	\$83
30 GAL.	550003693	ANODE KIT ALUMINUM (INCLUDES ANODE, GASKET & BUSHING)	\$42
40-50 GAL.	550003694	ANODE KIT ALUMINUM (INCLUDES ANODE, GASKET & BUSHING)	\$43
80-105 GAL.	550003695	ANODE KIT ALUMINUM (INCLUDES ANODE, GASKET & BUSHING)	\$83
30-50 GAL.	240012250	FLANGE CAP	\$45
80-105 GAL.	240012251	FLANGE CAP	\$17
30-50 GAL.	240012210	FLANGE GASKET	\$2
80-105 GAL.	240012238	FLANGE GASKET	\$4
40-50 GAL.	550003510	HARDWARE KIT (INCLUDES BOLTS & NUTS FOR FLANGE CAP)	\$4
80-105 GAL.	550003525	HARDWARE KIT (INCLUDES BOLTS & NUTS FOR FLANGE CAP)	\$4
H2O 30 GL	240012474	OUTSIDE TANK COVER	\$120
H2O 40 GL	240012329	OUTSIDE TANK COVER	\$122
H2O 50 GL	240012330	OUTSIDE TANK COVER	\$130
H2O 80 GL	240012331	OUTSIDE TANK COVER	\$142
H2O 105 GL	240012332	OUTSIDE TANK COVER	\$159
30-50 GAL.	240012483	TEMPERATURE GAUGE	\$18
80-105 GAL.	240012484	TEMPERATURE GAUGE	\$26

H2O SC Single Coil Stainless Steel Indirect Water Heaters

- 30 - 115 Gallon Capacities
- 316L Stainless Steel Construction
- Top Connections (For Easy Install)
- Stainless Steel Dip Tube
- Thermoplastic Jacket
- Low Pressure Drop
- T & P Valve, Stainless Steel Aquastat Well and Drain Valve
- 2.25" EPS Insulation
- Large Diameter, Smooth Coil Heat Exchangers - Prevent Buildup
- Honeywell L4080B Aquastat



H2O

I

Indirect

30

Capacity:
 30=30 gals
 40=40 gals
 50=50 gals
 60=60 gals
 80=80 gals
 85=87 gals
 115=115 gals

L

Type:
 L=Lowboy
 HO=High Output
 HOC=High Output
 Commercial
 XHO=Extra High
 Output

DK

DK=Dunkirk

General Information (See IOM for Complete Instructions)					
Maximum Working Pressure: 150 psi for all Capacities					
Model	Piping Connections NPT		Dimensions		
	Domestic Water In/Out	Boiler Water In/Out	Diameter	Height	Weight
H2OI30DK	3/4"	1"	23 1/2"	34"	85 lbs
H2OI40DK	3/4"	1"	23 1/2"	44"	100 lbs
H2OI40LDK	3/4"	1"	28"	36"	100 lbs
H2OI50DK	3/4"	1"	23 1/2"	54"	110 lbs
H2OI60DK	3/4"	1"	23 1/2"	62"	125 lbs
H2OI60LDK	3/4"	1"	28"	46"	120 lbs
H2OI80DK	1"	1"	28"	56"	140 lbs
H2OI115DK	1"	1"	28"	74"	175 lbs
High Output Units					
H2OI60HODK	1"	1"	23 1/2"	62"	145 lbs
H2OI80HODK	1"	1"	28"	56"	155 lbs
H2OI80HOC DK	1 1/2"	1 1/4"	28"	56"	155 lbs
H2OI115HODK	1"	1"	28"	74"	190 lbs
H2OI115HOC DK	1 1/2"	1 1/4"	28"	74"	190 lbs
Extra High Output Units 85XHO and 115XHO					
H2OI85XHOC DK	1 1/2"	1 1/2"	28"	64"	215 lbs
H2OI115XHOC DK	1 1/2"	1 1/2"	28"	74"	240 lbs

H2O SC - Single Coil Stainless Steel Indirect Water Heaters							
Item Number	Storage Capacity gal	Type	Max. First Hour Rating gal/hr @ 140° F/115° F		Boiler Output Req. BTU/hr	Shp. Wgt. lbs	Trade Price
H2OI30DK	30	STANDARD	202	269	131,250	85	\$1,927
H2OI40DK	40	STANDARD	221	292	138,670	100	\$1,984
H2OI40LDK	42	LOWBOY	212	251	132,000	100	\$2,113
H2OI50DK	50	STANDARD	223	291	133,280	110	\$2,394
H2OI60DK	60	STANDARD	262	342	155,700	125	\$2,864
H2OI60LDK	60	LOWBOY	239	310	138,570	120	\$2,945
H2OI80DK	80	STANDARD	271	348	149,390	140	\$3,172
H2OI115DK	115	STANDARD	324	409	165,750	175	\$4,709
H2OI60HODK	60	HIGH OUTPUT	406	541	263,600	145	\$3,088
H2OI80HODK	80	HIGH OUTPUT	418	551	259,640	155	\$4,291
H2OI80HOC DK	80	HIGH OUTPUT COMMERCIAL	442	584	227,070	155	\$4,632
H2OI115HODK	115	HIGH OUTPUT	467	607	273,100	190	\$5,803
H2OI115HOC DK	115	HIGH OUTPUT COMMERCIAL	479	623	281,300	190	\$6,143
H2OI85XHOC DK	87	EXTRA HIGH OUTPUT	738	992	495,000	215	\$5,766
H2OI115XHOC DK	115	EXTRA HIGH OUTPUT	763	1017	495,000	240	\$6,842

H2O DC Single & Dual Coil Stainless Steel Solar Water Heaters

- 60 - 115 Gallon Capacities
- 316L Stainless Steel Construction
- Top Connections (For Easy Install)
- Stainless Steel Dip Tube
- Thermoplastic Jacket
- Low Pressure Drop
- T & P Valve, Stainless Steel Aquastat Well and Drain Valve
- 2.25" EPS Insulation
- Large Diameter, Smooth Coil Heat Exchangers - Prevent Buildup
- Honeywell L4080B Aquastat



H2O

I

Indirect

60

Capacity:
 60=60 gals
 80=80 gals
 115=115 gals

D

D=Dual Coil

E

E=Electric Backup
 (3500 Watts)

DK

DK=Dunkirk

General Information (See IOM for Complete Instructions)				
Maximum Working Pressure: 150 psi for all Capacities				
Model	Piping Connections NPT	Dimensions		
		Diameter	Height	Weight
H2O160EDK	1"	23"	62"	135 lbs
H2O180EDK	1"	28"	56"	145 lbs
H2O115EDK	1"	28"	74"	180 lbs
H2O160DDK	1"	23"	62"	165 lbs
H2O180DDK	1"	28"	56"	175 lbs
H2O115DDK	1"	28"	74"	205 lbs
H2O160DEDK	1"	23"	62"	175 lbs
H2O180DEDK	1"	28"	56"	185 lbs
H2O115DEDK	1"	28"	74"	215 lbs

H2O DC - Single & Dual Coil Stainless Steel Solar Water Heaters						
Item Number	Storage Capacity gal	Type	Recovery Rate gal/hr		Ship Wgt. lbs	Trade Price
			Top Coil	Bottom Coil		
H2OI60EDK	60	ELECTRIC BACK-UP	N/A	214	135	\$3,675
H2OI80EDK	80	ELECTRIC BACK-UP	N/A	214	145	\$4,114
H2OI115EDK	115	ELECTRIC BACK-UP	N/A	214	180	\$5,560
H2OI60DDK	60	INDIRECT	185	214	165	\$3,798
H2OI80DDK	80	INDIRECT	180	214	175	\$4,325
H2OI115DDK	115	INDIRECT	190	214	205	\$5,537
H2OI60DEDK	60	ELECTRIC BACK-UP	185	214	175	\$5,132
H2OI80DEDK	80	ELECTRIC BACK-UP	180	214	185	\$5,796
H2OI115DEDK	115	ELECTRIC BACK-UP	190	214	215	\$7,271

H2O BT Stainless Steel Buffer Tanks, w/ and w/o Coil

- 22 - 115 Gallon Capacities
- 316L Stainless Steel Construction
- Top Connections (For Easy Installation)
- Thermoplastic Jacket
- Low Pressure Drop
- T & P Valve, Stainless Steel Aquastat Well and Drain Valve
- 2.25" EPS Insulation



H2O

BT
 BT=Buffer Tank

40
 Capacity:
 22=22 gals
 40=40 gals
 60=60 gals
 80=80 gals

114
 Connection:
 114=1 1/4" NPT
 112=1 1/2" NPT
 2=2" NPT

WC
 WC=With Coil

DK
 DK=Dunkirk

General Information (See IOM for Complete Instructions)				
Maximum Working Pressure: 150 psi for all Capacities				
Model	Piping Connections NPT	Dimensions		
		Diameter	Height	Weight
H2OBT22114DK	1 1/4"	22 1/2"	24 1/2"	35 lbs
H2OBT40114DK	1 1/4"	22 1/2"	42"	87 lbs
H2OBT40112DK	1 1/2"	22 1/2"	42"	87 lbs
H2OBT402DK	2"	22 1/2"	42"	87 lbs
H2OBT60114DK	1 1/4"	26 1/2"	44"	115 lbs
H2OBT60112DK	1 1/2"	26 1/2"	44"	115 lbs
H2OBT602DK	2"	26 1/2"	44"	115 lbs
H2OBT80114DK	1 1/4"	26 1/2"	54"	125 lbs
H2OBT80112DK	1 1/2"	26 1/2"	54"	125 lbs
H2OBT802DK	2"	26 1/2"	54"	125 lbs
H2OBT115114DK	1 1/4"	26 1/2"	72"	160 lbs
H2OBT115112DK	1 1/2"	26 1/2"	72"	160 lbs
H2OBT1152DK	2"	26 1/2"	72"	160 lbs
H2OBT40114WCDK	1 1/4"	22 1/2"	42"	97 lbs
H2OBT40112WCDK	1 1/2"	22 1/2"	42"	97 lbs
H2OBT402WCDK	2"	22 1/2"	42"	97 lbs
H2OBT60114WCDK	1 1/4"	26 1/2"	44"	125 lbs
H2OBT60112WCDK	1 1/2"	26 1/2"	44"	125 lbs
H2OBT602WCDK	2"	26 1/2"	44"	125 lbs
H2OBT80114WCDK	1 1/4"	26 1/2"	54"	135 lbs
H2OBT80112WCDK	1 1/2"	26 1/2"	54"	135 lbs
H2OBT802WCDK	2"	26 1/2"	54"	135 lbs
H2OBT115114WCDK	1 1/4"	26 1/2"	72"	170 lbs
H2OBT115112WCDK	1 1/2"	26 1/2"	72"	170 lbs
H2OBT1152WCDK	2"	26 1/2"	72"	170 lbs

H2O BT - Stainless Steel Buffer Tanks (With & Without Coil)				
Item Number	Storage Capacity gal	Type	Shp. Wgt. lbs	Trade Price
H2OBT22114DK	22	HYDRONIC BUFFER TANK	35	\$1,715
H2OBT40114DK	40	HYDRONIC BUFFER TANK	87	\$3,002
H2OBT40112DK	40	HYDRONIC BUFFER TANK	87	\$3,002
H2OBT402DK	40	HYDRONIC BUFFER TANK	87	\$3,002
H2OBT60114DK	60	HYDRONIC BUFFER TANK	115	\$3,574
H2OBT60112DK	60	HYDRONIC BUFFER TANK	115	\$3,574
H2OBT602DK	60	HYDRONIC BUFFER TANK	115	\$3,574
H2OBT80114DK	80	HYDRONIC BUFFER TANK	125	\$3,943
H2OBT80112DK	80	HYDRONIC BUFFER TANK	125	\$3,943
H2OBT802DK	80	HYDRONIC BUFFER TANK	125	\$3,943
H2OBT115114DK	115	HYDRONIC BUFFER TANK	160	\$4,910
H2OBT115112DK	115	HYDRONIC BUFFER TANK	160	\$4,910
H2OBT1152DK	115	HYDRONIC BUFFER TANK	160	\$4,910
H2OBT40114WCDK	40	HYDRONIC BUFFER TANKS (WITH COIL)	97	\$3,847
H2OBT40112WCDK	40	HYDRONIC BUFFER TANKS (WITH COIL)	97	\$3,847
H2OBT402WCDK	40	HYDRONIC BUFFER TANKS (WITH COIL)	97	\$3,847
H2OBT60114WCDK	60	HYDRONIC BUFFER TANKS (WITH COIL)	125	\$4,088
H2OBT60112WCDK	60	HYDRONIC BUFFER TANKS (WITH COIL)	125	\$4,088
H2OBT602WCDK	60	HYDRONIC BUFFER TANKS (WITH COIL)	125	\$4,088
H2OBT80114WCDK	80	HYDRONIC BUFFER TANKS (WITH COIL)	135	\$4,878
H2OBT80112WCDK	80	HYDRONIC BUFFER TANKS (WITH COIL)	135	\$4,878
H2OBT802WCDK	80	HYDRONIC BUFFER TANKS (WITH COIL)	135	\$4,878
H2OBT115114WCDK	115	HYDRONIC BUFFER TANKS (WITH COIL)	170	\$5,938
H2OBT115112WCDK	115	HYDRONIC BUFFER TANKS (WITH COIL)	170	\$5,938
H2OBT1152WCDK	115	HYDRONIC BUFFER TANKS (WITH COIL)	170	\$5,938

H2O ST Stainless Steel Storage Tanks

- 30 - 115 Gallon Capacities
- 316L Stainless Steel Construction
- Top Connections (For Easy Installation)
- Stainless Steel Dip Tube -Thermoplastic Jacket
- Low Pressure Drop
- T & P Valve, Stainless Steel Aquastat Well and Drain Valve
- 2.25” EPS Insulation
- Honeywell L4080B



H2O

ST

ST=Storage

30

Capacity:
 30=30 gals
 40=40 gals
 60=60 gals
 80=80 gals
 115=115 gals

L

Type:
 L=Lowboy
 C=Commercial

DK

DK=Dunkirk

General Information (See IOM for Complete Instructions)					
Maximum Working Pressure: 150 psi for all Capacities					
Model	Piping Connections NPT		Dimensions		
	Return/Supply	Heat Source Pressure	Diameter	Height	Weight
H2OST30DK	1”	1”	23 1/2”	34”	75 lbs
H2OST40DK	1”	1”	23 1/2”	44”	90 lbs
H2OST60DK	1”	1”	23 1/2”	62”	115 lbs
H2OST60LDK	1”	1”	23 1/2”	46”	110 lbs
H2OST80DK	1”	1”	28”	56”	140 lbs
H2OST115DK	1”	1”	28”	74”	175 lbs
H2OST80CDK	1 1/2”	1”	28”	56”	140 lbs
H2OST115CDK	1 1/2”	1”	28”	74”	175 lbs

H2O ST - Stainless Steel Storage Tanks (No Coil)				
Item Number	Storage Capacity gal	Type	Shp. Wgt. lbs	Trade Price
H2OST30DK	30	STANDARD STORAGE TANK	75	\$1,712
H2OST40DK	40	STANDARD STORAGE TANK	90	\$1,769
H2OST60DK	60	STANDARD STORAGE TANK	115	\$2,579
H2OST60LDK	60	LOWBOY STORAGE TANK	110	\$2,662
H2OST80DK	80	STANDARD STORAGE TANK	140	\$2,928
H2OST80CDK	80	COMMERCIAL STORAGE TANK	175	\$4,219
H2OST115DK	115	STANDARD STORAGE TANK	140	\$3,223
H2OST115CDK	115	COMMERCIAL STORAGE TANK	175	\$4,514

TERMS & CONDITIONS OF SALE - GENERAL TERMS

PRICES & SPECIFICATIONS: All pricing and specifications subject to change without notice. The prices herein supersede all prior quotations.

ORDERS: Orders will be accepted based on prices in effect at the time the order is received. No order or contract will become an obligation on our part until accepted by the General Sales Department. ECR International shall not be liable for any delay or failure in the delivery or shipment of goods due to any cause or causes beyond its control.

TAXES: Add to the prices and terms quoted any manufacturers' or sales tax payable on the transaction under any effective statute.

SHIPMENTS

TRUCKLOADS: \$60,000 Net Order Value - Freight Prepaid. Indirect Water Heaters and Commercial Boiler lines can be added to any residential order for freight purposes. Authorized Distributors can combine Argo, Airco, Dunkirk, EMI, Olsen, Pennco, Utica Boilers and Utica Heating on one purchase order to earn free freight.

Stop off charges of \$200 will apply to stop off locations within 100 miles of the final destination. Please call for pricing for stop off special handling for a location further than 100 miles or for special handling pricing for services such as lift gate, unloading assistance, etc.

LESS THAN TRUCKLOAD SHIPMENT: F.O.B. ECR INTERNATIONAL - FACTORY OR WAREHOUSE

See Shipping and Delivery Policy for full details.

SALES ORDER INFORMATION CHECK LIST

The following information must be included on equipment or parts orders to insure proper shipment & invoicing:

- | | |
|--|--|
| 1) Purchase Order Number | 7) Pricing |
| 2) Bill to Address | 8) Product Description (Model, Size, etc.) |
| 3) Ship to Address | 9) Fuel Type (Oil, Natural Gas, Propane) |
| 4) Method of Shipment (trailer load, UPS) | 10) Electrical (Operating Voltage, Cycles, Phases, etc.) |
| 5) Requested Ship Date | 11) Non-Standard Equipment (Indicate "Optional" when substituted for standard equipment at extra cost listed. Indicate added to standard equipment.) |
| 6) Special Instructions ("Carrier to call...") | 12) Kits or Parts (Orders for kits or parts must indicate equipment size and series.) |

Send orders to:

E-mail: ecrorderentry@ecrinternational.com

Fax: (315) 724-9319

Please note the following Remit to Address:

ECR International, Inc.

P.O. Box 8000 Department 039

Buffalo, NY 14267

SHIPPING AND DELIVERY POLICY

Shipping and Delivery Policy	
Order Type / Value*	Freight Charges*
All UPS, Fed, Ex, DHL, etc. Shipments	Freight & Handling Cost Apply
\$0.00 - \$5,000	Freight & Handling Cost Apply
\$5,001 - \$15,000	\$350
\$15,001 - \$59,999	\$300
\$60,000**	FFA

*The above freight terms apply to single purchase orders or combined purchase orders from one company with one stop totaling the above reference tiers. Additional stops will incur additional charges. Pooling from multiple companies is not allowed under this freight program.

**Orders of \$60,000 or more from one company with multiple stops will incur a \$200 stop-off charge per stop after the initial stop. Each stop location must be within 100 miles of the initial stop or additional charges will apply.

Because of packaging and shipping constraints, EMI products do not qualify for this freight program unless prior approval is obtained from your Regional Sales Manager.

Except for FFA qualifying orders, the above US shipping rates apply to shipments east of the Mississippi River. If shipments are beyond that area actual freight rates will apply.

These rates apply to destinations where no special delivery requirements are needed. Additional charges will apply when special handling and delivery is incurred. Pre-shipment notification of any special shipping or handling provisions is required. Unless otherwise noted, all products will be shipped FOB Shipping Point and transfer of ownership and responsibility is assumed by the customer for all loss or damage. ECR International will not be held liable for any damage, loss or costs which occur due to shipping delay. ECR retains the right to change or alter this program without notice and without penalty.

Family bundling is encouraged; boilers, furnaces, A/C, and controls can be combined to achieve freight tiers.

If you have any questions, please contact your ECR representative or ECR Regional Manager.

U.S. DISTRIBUTOR - RETURN MATERIAL POLICY (RMA)

Prior Approval Required - All returns for exchange, credit, repair service or warranty claim must be approved by ECR International and require an RMA number prior to return of the material. A request must be completed via the online web portal. Please log on to www.ecrcustomerportal.com to complete your request for return. If you do not already have access to the customer web portal, please contact ECR International Customer Service at 1-800-325-5479 to be set-up.

Eligibility – An RMA Request must be received within 60 days from the date of invoice for returns of New & Unused product in original packaging. A restocking fee of 15% will be charged for all new and unused returns that are approved for return. Special Order Products (items not offered as standard in ECR International trade price book) are not eligible for return as new and unused product. Request for Warranty Returns must be made within the period covered by the warranty and must fall under the terms and conditions specified in the warranty.

Repair Service - Request for repair or rework of product damaged by customer is classified as Repair Service. Repair Service is billed at \$75.00 per hour for labor and net price for parts used in repair/rework. ECR International's Return Material (RM) department will evaluate the items returned for repair service. The customer will receive an estimate for the dollar amount, determined by ECR International's RM department, required to complete the repairs requested. A Purchase Order (PO) from the customer for that amount will be required before any work is performed.

RMA Expiration Parts - Once the RMA number is issued, the product must be returned within 60 days of the RMA date, or the RMA will be canceled. Products approved for return that are received after 60 days from the RMA date will not be accepted.

Shipping & Packaging - All returns must have a valid RMA number clearly displayed on the exterior of the package or the package will not be accepted. All returns of new and unused product must be in the original packaging. All returns must be shipped prepaid by the customer unless otherwise directed by ECR as indicated on the RMA Verification. Ship all approved return material to the facility indicated on the approved RMA Request by the date indicated.

Replacement Product - If replacement product is desired it must be indicated on the RMA Request. A PO# is required for the replacement shipment and must be indicated on the RMA Request. All replacement products will be invoiced at the time of shipment. ECR will pay the ground freight for all warranty replacements.

Application of Credit - Credit for returned product will be applied to the customer's account (less restocking fees for New and Unused returns) only after confirmation of receipt by ECR and inspection of the product. Issuance of a credit for a partial return of product does not relieve the customer from the obligation to remit payment for the merchandise not returned in accordance with the payment terms referenced on the customer's invoice(s). Customer will have the option to have any product that is denied for credit returned at their expense.

Returning Installed Finished Goods (Complete boilers, furnaces, A/C units etc.)

- Equipment that is already installed should be repaired not replaced. Exceptions: leaking cast iron boilers in their first year or leaking water tanks. Leaking drain valves on water tanks are replaceable, make sure the leak is not on the valve. Tanks returned with the only leak being on the valve will be denied.
- Cast iron blocks (not complete boilers) older than one year and Indirect tanks that are leaking do not require prior approval. Simply type "Leaking" into the Authorization field and it will be accepted. Complete Cast iron boilers within their first year will still require prior authorization for full boiler replacement.
- Water leaks on copper and condensing boilers are repairable and will require prior authorization for any reason for removal.
- To guarantee credit, if a situation arises where equipment does need to be replaced, **prior authorization** from ECR is required. This will ensure that ECR has visibility to the problem and has had an opportunity to correct it prior to removal. *All equipment considered for removal should first be brought to the attention of Technical Support at 1-800-253-7900.*
- If approved, an authorization number will be given that will need to be entered in the RMA on the Customer Portal.
- For equipment that is removed from service without prior authorization by ECR, contact Customer Service. They will evaluate the circumstance and can issue a conditional RMA. The equipment will be tested in our lab to determine if removal was warranted and if credit will be given.

RMA Expiration Equipment - Once the RMA number is issued, the product must be returned within 30 days of the RMA date, or the RMA will be canceled. Products approved for return that are received after 30 days from the RMA date will not be accepted.

**This page is intentionally left blank,
products continue on the following page.**



Innovative. Efficient. Dependable. Dunkirk.

www.dunkirk.com



2201 Dwyer Avenue, Utica, NY 13501
Tel. 800 325 5479
www.ecrinternational.com

All specifications subject to change without notice.
©2022 ECR International, Inc.
PN 240005064 REV. U [12/20/2022]