



US Trade Price Book - 2023

Effective 2/15/23



As rugged as the outdoors...
for dependable comfort every day

www.greenmountainboilers.com



Manufactured by:
ECR International Inc.
2201 Dwyer Avenue, Utica, NY 13501
Tel. 800 325 5479
www.ecrinternational.com
PN 240011133 REV. Q [08/15/2023]



CUSTOMER SUPPORT TEAM

CUSTOMER SERVICE:

Phone: (800) 325-5479 option #2
Fax: (315) 724-9319
Email Purchase Orders: ecrorderentry@ecrinternational.com
Email Inquiries: customerservice@ecrinternational.com

TECHNICAL SUPPORT:

Phone: (800) 253-7900
Fax: (866) 432-7329
Email: technical.support@ecrinternational.com

MARKETING SUPPORT:

Phone: (800) 325-5479
Fax: (315) 733-1759
E-mail: marketing@ecrinternational.com

WWW.ECRCUSTOMERPORTAL.COM

Your On-line Access to:

- Order Status
- Invoices
- Statements
- RMA
- Serial Number Look-Up
- Literature

TABLE OF CONTENTS

| | | |
|--|---|--------------|
| Condensing Natural / LP Boilers | | 4-5 |
| GMHB/GMCB | Stainless Steel Combi & Heating Boilers (122-379 MBH) | 4 |
| Venting | | 6-9 |
| VENTING | Coaxial, Twin Pipe & CPVC Venting for Condensing Boilers | 6 |
| Natural / LP Boilers | | 10-15 |
| GMGW | Cast-Iron Chimney Vented Boilers (59-299 MBH) | 10 |
| GMPVB | Cast-Iron Induced Draft Chimney/Side Wall Vented Boilers (42-187 MBH) | 12 |
| GMGS | Cast-Iron Steam Boilers (75-299 MBH) | 14 |
| Oil Boilers | | 16-19 |
| GMOW | Cast-Iron Chimney Vented Boilers (119-259 MBH) | 16 |
| GMSBO | Cast-Iron Steam Boilers (119-210 MBH) | 18 |
| Indirect Tanks | | 20-21 |
| H2O GL | Single Coil Glass Lined Indirect Water Heaters (31-106 GALS) | 20 |
| Terms & Conditions of Sale | | 22 |
| Shipping & Delivery Policy | | 23 |
| RMA Policy | | 24 |

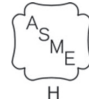

GMHB / GMCB Stainless Steel Combi & Heating Boilers

- MBH Input 122 - 379 (CH) / 147 - 200 (DHW)
- 95% AFUE - ENERGY STAR® Certified (95% Thermal Efficiency GMHB-380)
- Up to 6.25:1 Turndown Ratio
- 3.4 gpm DHW (GMCB-150) @ 70°F Rise
- 4.9 gpm DHW (GMCB-200) @ 70°F Rise
- Stainless Steel Primary Heat Exchanger





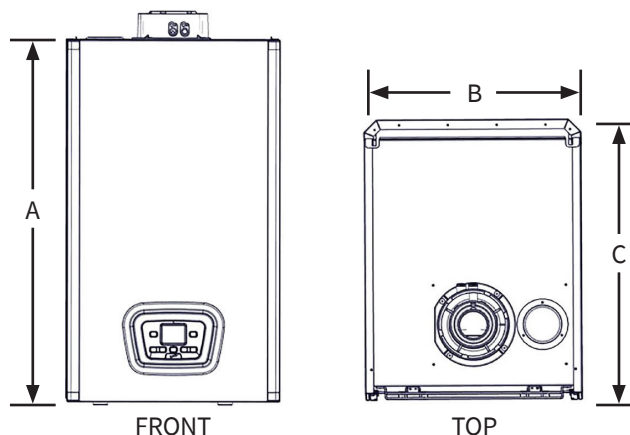











| General Information (See IOM for Complete Instructions) | | | | | | |
|---|---|----------|----------|----------|------------|------------|
| Model | GMHB-125 | GMCB-150 | GMHB-160 | GMCB-200 | GMHB-227 | GMHB-380 |
| Water Return/Supply | 1" NPT | | 1" NPT | | 1 1/4" NPT | 1 1/2" NPT |
| Gas | 3/4" NPT | | 3/4" NPT | | 3/4" NPT | 1" NPT |
| Condensate Trap | 3/4" NPT | | 3/4" NPT | | 3/4" NPT | |
| DHW Outlet (125 Optional) | 3/4" NPT | | 3/4" NPT | | NA | |
| DHW (Cold Water) Inlet | 3/4" NPT | | 3/4" NPT | | NA | |
| Electrical | 120 Volts AC, 60 hertz, 1 phase, less than 12 amps (15 amp circuit recommended) | | | | | |
| Water Content (Gallons) | 1 | | 1 1/4 | | 1 1/4 | 4.6 |
| Dimensions | A-Height | 30" | | 30" | | 37 7/16" |
| | B-Width | 17 3/4" | | 17 3/4" | | 23 5/8" |
| | C-Depth | 14" | | 23" | | 25 3/8" |



















| GMHB/GMCB - Stainless Steel Combi & Heating Boilers | | | | | | | | | |
|--|--------------------|--|-------------------------|---------------------|-------------|--------------|-------------|----------------------|--------------------|
| Model | Item Number | Type | Input MBH CH/DHW | AHRI Net MBH | Fuel | AFUE% | Pump | Shp. Wgt. lbs | Trade Price |
| GMHB125 | ECR112203800104 | HEATING | 126 | 97 | NAT/LP | 95 | LESS | 102 | \$3,904 |
| GMHB165 | ECR116003800104 | HEATING | 164 | 129 | NAT/LP | 95 | LESS | 125 | \$4,643 |
| GMHB227 | ECR122703800104 | HEATING | 227 | 183 | NAT/LP | 95 | LESS | 120 | \$9,120 |
| GMHB380 | ECR138003800104 | HEATING | 379 | 303 | NAT/LP | 95 | LESS | 225 | \$13,457 |
| GMCB150 | ECR114703800104 | COMBI | 126/153 | 97 | NAT/LP | 95 | LESS | 103 | \$4,201 |
| GMCB205 | ECR120003800104 | COMBI | 164/205 | 129 | NAT/LP | 95 | LESS | 125 | \$4,863 |
| GMHB/GMCB (Use Parts Multiplier for All of the Following) | | | | | | | | | |
| Model | Item Number | Description | | | | | | | Trade Price |
| GMHB/CB | BD710487302V | OUTSIDE AIR SENSOR | | | | | | | \$47 |
| GMHB/CB | 550003189 | DHW SENSOR KIT | | | | | | | \$102 |
| GMHB/CB | 550003332 | CSD-1 KIT (INCLUDES HIGH LIMIT AND MANUAL REST LWCO) | | | | | | | \$655 |
| GMHB125 | 550003506 | GMHB125/GMCB150 NATURAL GAS TO LP GAS CONVERSION KIT | | | | | | | \$69 |
| GMHB160 | 550003507 | GMHB160 NATURAL GAS TO LP GAS CONVERSION KIT | | | | | | | \$74 |
| GMCB200 | 550003546 | GMCB200 NATURAL GAS TO LP GAS CONVERSION KIT | | | | | | | \$49 |
| GMHB227 | 550003508 | GMHB227 NATURAL GAS TO LP GAS CONVERSION KIT | | | | | | | \$166 |
| GMHB380 | 550003509 | GMHB380 NATURAL GAS TO LP GAS CONVERSION KIT | | | | | | | \$166 |
| GMHB/CB | 240010266 | FLOOR STAND KIT | | | | | | | \$852 |
| GMHB/CB | 550003212 | HEAT EXCHANGER CLEANING KIT | | | | | | | \$71 |



VENTING

| | | | | | Coaxial Venting | | |
|---------|---------|---------|---------|---|-----------------|--|-------------|
| 125/150 | 160/200 | GMHB227 | GMHB380 | Image | Item Number | Description | Trade Price |
| X | | | |  | KUG714059511 | 2"x4" (60/100mm)COAXIAL PIPE 3.28' (1m) L | \$50 |
| X | | | |  | KUG714059611 | 2"x4" (60/100mm)HORIZONTAL VENT TERM | \$63 |
| X | | | |  | KUG714059711 | 2"x4" (60/100mm)COAXIAL 90 ELBOWS | \$40 |
| X | | | |  | KUG714059811 | 2"x4" (60/100mm)COAXIAL 45 ELBOWS | \$40 |
| X | | | |  | KUG714135813 | 2"x4" (60/100mm)VERTICAL VENT TERM | \$149 |
| | X | X | |  | KHG714088512 | 3"x5" (80/125mm)COAXIAL PIPE 3.28' (1m) L | \$74 |
| | X | X | |  | KHG714088713 | 3"x5" (80/125mm)COAXIAL 90 ELBOWS | \$41 |
| | X | X | |  | KHG714088812 | 3"x5"(80/125mm)COAXIAL 45 ELBOWS | \$41 |
| | X | X | |  | KHG714088911 | 3"x5" (80/125mm)HORIZONTAL VENT TERM | \$84 |
| | X | X | |  | KHG714093512 | 3"x5" (80/125mm)VERTICAL VENT TERM | \$117 |
| | | | X |  | KUG714133311 | 4"x6" (110/160mm)HORIZONTAL VENT TERM | \$309 |
| | | | X |  | KUG714133411 | 4"x6"(110/160mm)VERTICAL VENT TERM | \$392 |
| | | | X |  | KUG714133511 | 4"x6" (110/160mm)COAXIAL 45 ELBOWS | \$110 |
| | | | X |  | KUG714133611 | 4"x6" (110/160mm)COAXIAL 90 ELBOWS | \$110 |
| | | | X |  | KUG714133811 | 4"x6" (110/160mm)COAXIAL PIPE 3.28' (1m) L | \$151 |

VENTING

| | | | | | Twin Pipe Polypropylene Venting | | | |
|---------|---------|---------|---------|---|---------------------------------|--|-------------|--|
| 125/150 | 160/200 | GMHB227 | GMHB380 | Image | Item Number | Description | Trade Price | |
| X | | | |  | KHG714059113 | TO CONVERT FROM CONCENTRIC TO 3" TWIN PIPE POLYPROPYLENE | \$22 | |
| X | X | X | |  | 550003416 | 3" (80mm)VENTING CLAMP SINGLE WALL | \$47 | |
| X | X | X | |  | 550003452 | 3" (80mm)CLAMSHELL CLAMP (5PK) | \$46 | |
| X | X | X | |  | KUG714132010 | 3" (80mm)HORIZONTAL VENT TERM | \$25 | |
| X | X | X | |  | KUG714132110 | 3" (80mm)VERTICAL VENT TERM | \$62 | |
| X | X | X | |  | 550003734 | 3" (80mm)POLYPROPYLENE 45 ELBOWS W/ CLAMP | \$19 | |
| X | X | X | |  | 550003735 | 3" (80mm)POLYPROPYLENE 90 ELBOWS W/ CLAMP | \$19 | |
| X | X | X | |  | 550003767 | 3" (80mm)POLYPROPYLENE PIPE 3.28' (1m) L W/ CLAMP | \$27 | |
| | X | X | |  | KHG714089010 | TO CONVERT FROM CONCENTRIC TO 3" TWIN PIPE POLYPROPYLENE | \$50 | |
| | | | X |  | 550003453 | 4" (110mm)CLAMSHELL CLAMP (5PK) | \$62 | |
| | | | X |  | BD7106314V | TO CONVERT FROM CONCENTRIC TO 4" TWIN PIPE POLYPROPYLENE | \$164 | |
| | | | X |  | KUG714132710 | 4" (110mm)HORIZONTAL VENT TERM | \$159 | |
| | | | X |  | KUG714132810 | 4" (110mm)VERTICAL VENT TERM | \$142 | |
| | | | X |  | 550003731 | 4" (110mm)POLYPROPYLENE 45 ELBOWS W/ CLAMP | \$42 | |
| | | | X |  | 550003732 | 4" (110mm)POLYPROPYLENE 90 ELBOWS W/ CLAMP | \$42 | |
| | | | X |  | 550003733 | 4" (110mm)POLYPROPYLENE PIPE 3.28' (1m) L W/ CLAMP | \$57 | |

VENTING

| Twin Pipe CPVC Venting | | | | | | | |
|------------------------|---------|---------|---------|---|-------------|-----------------------------------|-------------|
| 125/150 | 160/200 | GMHB227 | GMHB380 | Image | Item Number | Description | Trade Price |
| X | | | |  | 550003184 | TWIN PIPE ADAPTER 60MM TO CPVC 3" | \$74 |
| | X | X | |  | 550003403 | TWIN PIPE ADAPTER 80MM TO CPVC 3" | \$138 |

**This page is intentionally left blank,
products continue on the following page.**

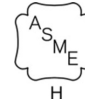

GMGW Cast-Iron Chimney Vented Boilers

- MBH Input 59 - 235 (CH)
- 84% AFUE
- Dependable Cast Iron Heat Exchanger
- Internal Operating Control
- Digital temperature display and diagnostics
- Built-In Low Water Cut-Off (LWCO)
- Control monitors water temperature and delays burner start until residual heat has been transferred to the system for maximum efficiency.
- Low Profile draft hood diverter

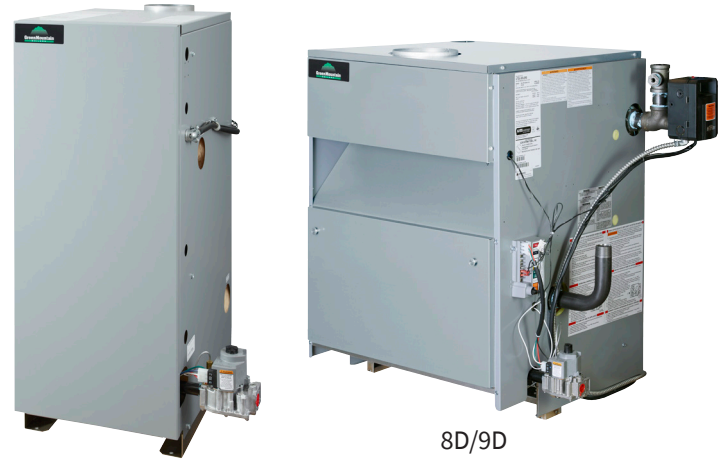

GMGW-8D/9D

- MBH Input 262 - 299 (CH)

| General Information (See IOM for Complete Instructions) | | | | | | | |
|---|---|-----------|-----------|-----------|-----------|-----------|-----------|
| | GMGW-060K | GMGW-095K | GMGW-120K | GMGW-150K | GMGW-175K | GMGW-205K | GMGW-235K |
| Water Return/Supply | 1 1/4" NPT | | | | | | |
| Gas | 1/2" NPT | | | | 3/4" NPT | | |
| Electrical | 120 Volts AC, 60 hertz, 1 phase, less than 12 amps (15 amp circuit recommended) | | | | | | |
| Water Content (Gallons) | 1.9 | 2.3 | 2.8 | 3.2 | 3.7 | 4.1 | 4.6 |
| A-Height | 32 1/8" | 32 1/8" | 32 1/8" | 32 1/8" | 32 1/8" | 32 1/8" | 32 1/8" |
| B-Width | 13 3/8" | 13 3/8" | 16 1/4" | 19" | 21 7/8" | 27 1/2" | 27 1/2" |
| C-Depth | 24 1/8" | 24 1/8" | 24 1/8" | 24 1/8" | 24 1/8" | 24 1/8" | 24 1/8" |

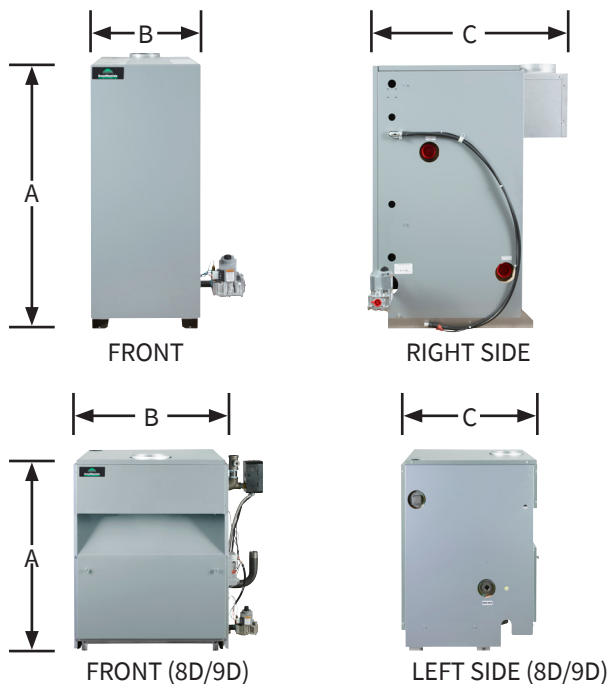

| Model | GMGW-8D | GMGW-9D |
|-------------------------|---|---------|
| Water Return/Supply | 1 1/4" NPT | |
| Gas | 1/2" NPT | |
| Electrical | 120 Volts AC, 60 hertz, 1 phase, less than 12 amps (15 amp circuit recommended) | |
| Water Content (Gallons) | 12.7 | 14.4 |
| A-Height | 36 3/8" | 36 3/8" |
| B-Width | 27 1/2" | 30 3/4" |
| C-Depth | 26 1/2" | 26 1/2" |

GMGW - Cast-Iron Chimney Vented Boilers

| Model | Item Number | Fuel | Input MBH | Htg. Cap. MBH | AHRI Net MBH | AFUE% | Pump | Shp. Wgt. lbs | No. of Brns. | Trade Price |
|-----------|-----------------|------|-----------|---------------|--------------|-------|------|---------------|--------------|-------------|
| GMGW-060K | 15B306003710304 | NAT | 59 | 50 | 43 | 84.0 | TACO | 215 | 1 | \$2,703 |
| GMGW-095K | 15B409503710304 | NAT | 92.5 | 78 | 68 | 84.0 | TACO | 250 | 2 | \$2,960 |
| GMGW-120K | 15B512003710304 | NAT | 120 | 101 | 88 | 84.0 | TACO | 295 | 2 | \$3,179 |
| GMGW-150K | 15B615003710304 | NAT | 149 | 125 | 109 | 84.0 | TACO | 335 | 3 | \$3,550 |
| GMGW-175K | 15B717503710304 | NAT | 175 | 147 | 128 | 84.0 | TACO | 385 | 3 | \$3,909 |
| GMGW-205K | 15B820503710304 | NAT | 205 | 172 | 150 | 84.0 | TACO | 420 | 4 | \$4,392 |
| GMGW-235K | 15B923503710304 | NAT | 235 | 197 | 172 | 84.0 | TACO | 465 | 4 | \$4,781 |
| GMGW-8D | 15C826203210304 | NAT | 262 | 221 | 192 | 84.0 | TACO | 552 | 7 | \$5,325 |
| GMGW-9D | 15C929903210304 | NAT | 299 | 252 | 219 | 84.0 | TACO | 616 | 8 | \$5,626 |

GMGW - LP

Note: Boilers require a natural gas to LP conversion kit (field installed). Sold Separately. See below.

GMGW - High Altitude

***Note: Boilers require a High Altitude conversion kit (field installed). Sold Separately. See Below. Item # is for 5000', consult factory for other elevations up to 10,000'.**

High Altitude - Capacity Reduces with Elevation. Refer to IOM for Actual Capacity Ratings.

GMGW (Use Parts Multiplier for All of the Following)

| Model | Item Number | Description | Trade Price |
|------------------|-------------|---|-------------|
| GMGW-K | 550003778 | NATURAL GAS TO LP GAS CONVERSION KIT | \$97 |
| GMGW-K | 550003884 | LP GAS TO NATURAL GAS CONVERSION KIT | \$107 |
| GMGW-8D/9D | 550004168 | CONVERSION KIT NAT. TO LP GMGW-8D/9D | \$131 |
| GMGW-8D | 43300636 | CONVERSION KIT LP TO NAT. GMGW-8D | \$267 |
| GMGW-9D | 43300637 | CONVERSION KIT LP TO NAT. GMGW-9D | \$267 |
| GMGW-K (3 Sec) | 550003786 | *NATURAL GAS HIGH ALTITUDE CONVERSION KIT - 5000' ELEVATION | \$67 |
| GMGW-K (4 Sec) | 550003880 | *NATURAL GAS HIGH ALTITUDE CONVERSION KIT - 5000' ELEVATION | \$67 |
| GMGW-K (5-9 Sec) | 550003781 | *NATURAL GAS HIGH ALTITUDE CONVERSION KIT - 5000' ELEVATION | \$84 |
| GMGW-K (3 Sec) | 550003774 | *LP GAS HIGH ALTITUDE CONVERSION KIT - 5000' ELEVATION | \$76 |
| GMGW-K (4 Sec) | 550003776 | *LP GAS HIGH ALTITUDE CONVERSION KIT - 5000' ELEVATION | \$67 |
| GMGW-K (5-9 Sec) | 550003774 | *LP GAS HIGH ALTITUDE CONVERSION KIT - 5000' ELEVATION | \$76 |
| GMGW-8D/9D | 14624002 | FILL-TROL #110 FOR WATER BOILERS 150 MBH OR LESS | \$421 |
| GMGW-8D/9D | 14624003 | FILL-TROL #111 FOR WATER BOILERS OVER 150 MBH | \$585 |

GMPVB Cast-Iron Induced Draft Chimney/Side Wall Vented Boilers

- MBH Input 42.5 - 187.5 (CH)
- Up to 84.4% AFUE
- Dependable Cast Iron Heat Exchanger with Cast Iron Push Nipples
- Honeywell High Limit/Electronic Ignition Control
 - Recessed under the boiler's protective jacket
 - Digital Temperature display and diagnostics
 - Plug in connection for the inducer fan
 - Plug in connection for the system pump
- Induced Draft Fan



| General Information (See IOM for Complete Instructions) | | | | | | |
|---|---|----------|-----------|-----------|-----------|---------|
| Model | GMPVB-42 | GMPVB-75 | GMPVB-112 | GMPVB-150 | GMPVB-188 | |
| Water Return/Supply | 1 1/4" NPT | | | | | |
| Gas | 1/2" NPT | | | | | |
| Electrical | 120 Volts AC, 60 hertz, 1 phase, less than 12 amps (15 amp circuit recommended) | | | | | |
| Water Content (Gallons) | 1.75 | 3.00 | 4.25 | 5.50 | 6.75 | |
| Dimensions | A-Height | 29" | 29" | 29" | 29" | |
| | B-Width | 11" | 14 1/4" | 17 1/2" | 20 3/4" | 24" |
| | C-Depth | 23 1/4" | 23 1/4" | 23 1/4" | 23 1/4" | 23 1/4" |

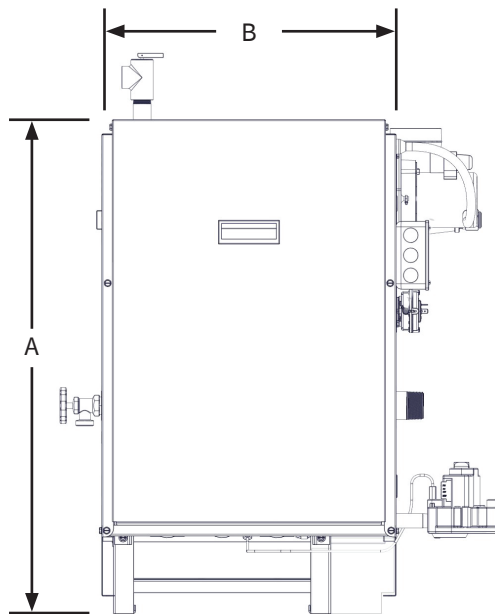

FRONT

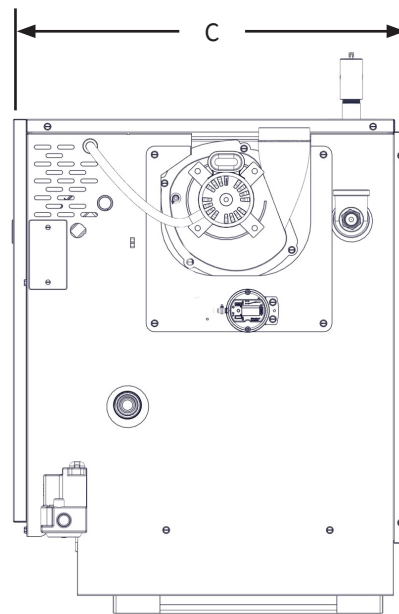

RIGHT SIDE

GMPVB - Cast-Iron Induced Draft Chimney/Side Wall Vented Boilers

| Model | Item Number | Fuel | Input MBH | Htg. Cap. MBH | AHRI Net MBH | Pump | AFUE% | Shp. Wgt. Lbs | Chimney Cat. I | Side Wall Cat. III | Trade Price |
|-----------|-----------------|------|-----------|---------------|--------------|------|-------|---------------|----------------|--------------------|-------------|
| GMPVB-42 | FSB204203110304 | NAT | 42.5 | 36 | 31 | TACO | 84.4 | 225 | 4" | 3" | \$2,881 |
| GMPVB-75 | FSB307503110304 | NAT | 75 | 63 | 55 | TACO | 84.0 | 265 | 4" | 3" | \$3,252 |
| GMPVB-112 | FSB411203110304 | NAT | 112.5 | 95 | 82 | TACO | 84.0 | 322 | 4" | 3" | \$3,585 |
| GMPVB-150 | FSB515003110304 | NAT | 150 | 127 | 109 | TACO | 84.0 | 370 | 4" | 3" | \$4,014 |
| GMPVB-188 | FSB618703110304 | NAT | 187.5 | 158 | 135 | TACO | 84.0 | 431 | 4" | 4" | \$4,698 |

GMPVB - LP

Note: Boilers require a natural gas to LP conversion kit (field installed). Sold Separately. See below.

GMPVB - High Altitude

***Note: Boilers require a High Altitude conversion kit (field installed). Sold Separately. See Below. Item # is for 5000', consult factory for other elevations up to 10,000'.**

High Altitude - Capacity Reduces with Elevation. Refer to IOM for Actual Capacity Ratings.

GMPVB (Use Parts Multiplier for All of the Following)

| Model | Item Number | Description | Trade Price |
|-------------|-------------|---|-------------|
| GMPVB | 550002722 | NATURAL TO LP CONVERSION KIT (ALL SIZES) | \$120 |
| GMPVB | 43300660 | LP TO NATURAL CONVERSION KIT (ALL SIZES) | \$131 |
| GMPVB-2 | 550004122 | *NATURAL GAS HIGH ALTITUDE CONVERSION KIT - 5000' ELEVATION | \$120 |
| GMPVB (3-5) | 550004129 | *NATURAL GAS HIGH ALTITUDE CONVERSION KIT - 5000' ELEVATION | \$120 |
| GMPVB-6 | 550004136 | *NATURAL GAS HIGH ALTITUDE CONVERSION KIT - 5000' ELEVATION | \$120 |
| GMPVB-2 | 550004142 | *LP GAS HIGH ALTITUDE CONVERSION KIT - 5000' ELEVATION | \$120 |
| GMPVB (3-5) | 550004145 | *LP GAS HIGH ALTITUDE CONVERSION KIT - 5000' ELEVATION | \$120 |
| GMPVB-6 | 550004149 | *LP GAS HIGH ALTITUDE CONVERSION KIT - 5000' ELEVATION | \$120 |
| GMPVB | 14629010 | TJERNLUND VH-1-3" SIDE WALL VENT HOOD (GMPVB-2 TO GMPVB-5) | \$333 |
| GMPVB | 14629011 | TJERNLUND VH-1-4" SIDE WALL VENT HOOD (GMPVB-6) | \$395 |

GMGS Cast-Iron Steam Boilers

- MBH Input 75 - 299 (CH)
- Up to 82.7% AFUE
- 7 Sizes Available
- Dependable Cast-Iron Heat Exchanger
- Electronic Ignition System
- Automatic Vent Damper
- LWCO (Probe Type) externally mounted for quick access
- Pressure High Limit Control with Pressure Gauge and Gauge Glass
- Stainless Steel Burners
- Easy Serviceability



| General Information (See IOM for Complete Instructions) | | | | | | | |
|---|---|----------|----------|----------|----------|----------|----------|
| Model | GMGS075E | GMGS112E | GMGS150E | GMGS187E | GMGS225E | GMGS262E | GMGS299E |
| Steam Return/Supply | 2 1/2" NPT | | | | | | |
| Electrical | 120 Volts AC, 60 hertz, 1 phase, less than 12 amps (15 amp circuit recommended) | | | | | | |
| A-Height | 36.375" | 36.375" | 36.375" | 36.375" | 36.375" | 36.375" | 36.375" |
| B-Width | 11 1/4" | 14 1/2" | 17 3/4" | 21" | 24 1/4" | 27 1/2" | 30 3/4" |
| C-Depth | 26 1/2" | 26 1/2" | 26 1/2" | 26 1/2" | 26 1/2" | 26 1/2" | 26 1/2" |

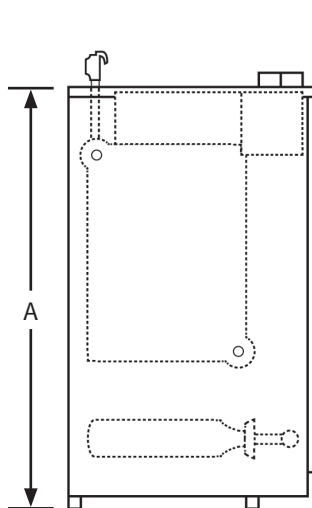

LEFT SIDE

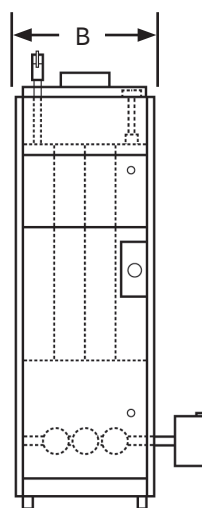

FRONT

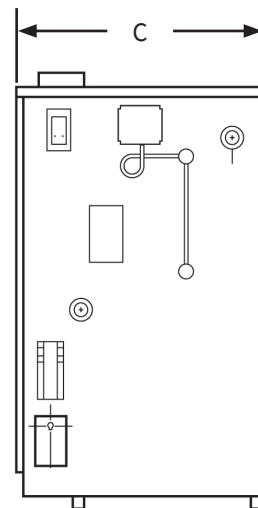

RIGHT SIDE

GMGS SERIES - Cast-Iron Steam Boiler

| Model | Item Number | Fuel | Input MBH | Htg. Cap. MBH | AHRI Net MBH | AHRI Net SQ. FT. Steam | AFUE% | Shp. Wgt. lbs | Trade Price |
|----------|-----------------|------|-----------|---------------|--------------|------------------------|-------|---------------|-------------|
| GMGS075E | 16B307503100204 | NAT | 75 | 62 | 47 | 195 | 82.7% | 297 | \$3,380 |
| GMGS112E | 16B411203100204 | NAT | 112 | 91 | 68 | 283 | 82.0% | 368 | \$3,780 |
| GMGS150E | 16B515003100204 | NAT | 150 | 122 | 92 | 383 | 82.0% | 440 | \$4,223 |
| GMGS187E | 16B618703100204 | NAT | 187 | 153 | 115 | 479 | 82.0% | 512 | \$4,827 |
| GMGS225E | 16B722503100204 | NAT | 225 | 183 | 137 | 570 | 82.0% | 584 | \$5,391 |
| GMGS262E | 16B826203100204 | NAT | 262 | 214 | 161 | 670 | 82.0% | 659 | \$5,956 |
| GMGS299E | 16B929903100204 | NAT | 299 | 245 | 184 | 766 | 82.0% | 736 | \$6,344 |

GMGS - LP

Note: Boilers require a natural gas to LP conversion kit (field installed). Sold Separately. See below.

GMGS - High Altitude

***Note: Boilers require a High Altitude conversion kit (field installed). Sold Separately. See Below. Item # is for 5000', consult factory for other elevations up to 10,000'.**

High Altitude - Capacity Reduces with Elevation. Refer to IOM for Actual Capacity Ratings.

GMGS SERIES (Use Parts Multiplier for All of the Following)

| Model | Item Number | Description | Trade Price |
|----------|-------------|---|-------------|
| GMGS075E | 43300723 | 3 SECTION NATURAL GAS TO LP GAS CONVERSION KIT | \$71 |
| GMGS112E | 43300724 | 4 SECTION NATURAL GAS TO LP GAS CONVERSION KIT | \$71 |
| GMGS150E | 43300725 | 5 SECTION NATURAL GAS TO LP GAS CONVERSION KIT | \$71 |
| GMGS187E | 43300726 | 6 SECTION NATURAL GAS TO LP GAS CONVERSION KIT | \$84 |
| GMGS225E | 43300727 | 7 SECTION NATURAL GAS TO LP GAS CONVERSION KIT | \$84 |
| GMGS262E | 43300728 | 8 SECTION NATURAL GAS TO LP GAS CONVERSION KIT | \$84 |
| GMGS299E | 43300729 | 9 SECTION NATURAL GAS TO LP GAS CONVERSION KIT | \$84 |
| GMGS112E | 43300632 | 4 SECTION LP GAS TO NATURAL GAS CONVERSION KIT | \$265 |
| GMGS150E | 43300633 | 5 SECTION LP GAS TO NATURAL GAS CONVERSION KIT | \$269 |
| GMGS187E | 43300634 | 6 SECTION LP GAS TO NATURAL GAS CONVERSION KIT | \$263 |
| GMGS225E | 43300635 | 7 SECTION LP GAS TO NATURAL GAS CONVERSION KIT | \$265 |
| GMGS262E | 43300636 | 8 SECTION LP GAS TO NATURAL GAS CONVERSION KIT | \$267 |
| GMGS299E | 43300637 | 9 SECTION LP GAS TO NATURAL GAS CONVERSION KIT | \$267 |
| GMGS | 550004368 | *NATURAL GAS HIGH ALTITUDE CONVERSION KIT - 5000' ELEVATION | \$80 |
| GMGS | 550004373 | *LP GAS HIGH ALTITUDE CONVERSION KIT - 5000' ELEVATION | \$80 |
| GMGS | 1630001 | MCDONNELL & MILLER WF-2U-24 ELECTRONIC WATER FEEDER | \$674 |

GMOW Cast-Iron Chimney Vent Boilers

- MBH Input 119 - 259 (CH)
- Up to 87% AFUE
- Dependable Cast Iron Heat Exchanger with Cast Iron Push Nipples
- Hydrolevel Operating Control
 - Digital Temperature display and diagnostics
 - Adjusts water temperature based on heating system demand
 - Built-In Low Water Cut-Off (LWCO)
 - Boiler Reset
- Burner swing door for easy serviceability
- Multiple Firing Rates
- Optional tankless domestic hot water (DHW) coil



| General Information (See IOM for Complete Instructions) | | | | | |
|---|---|-----------|-----------|-----------|-----------|
| GMOW | 3085(T) | 4100(T) | 4125(T) | 5160(t) | 6185(T) |
| Water Return/Supply | 1 1/2" Return NPT, 2" Supply NPT | | | | |
| Oil | 3/8" O.D. Copper (runs 50' or less, 1/2" O.D. Copper (runs over 50') | | | | |
| Electrical | 120 Volts AC, 60 hertz, 1 phase, less than 12 amps (15 amp circuit recommended) | | | | |
| Water Content (Gallons) | 10.5 | 13.5 | 13.5 | 16.5 | 19.5 |
| Dimensions | A-Height | 35" | 35" | 35" | 35" |
| | B-Width | 21 13/16" | 21 13/16" | 21 13/16" | 21 13/16" |
| | C-Depth | 17 7/8" | 21 1/2" | 21 1/2" | 25 1/8" |

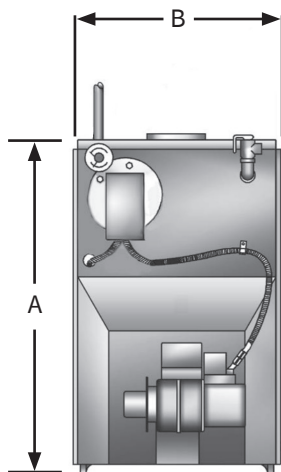

FRONT

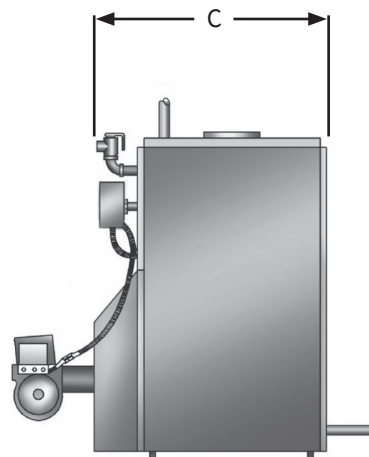

RIGHT SIDE

GMOW - Cast-Iron Chimney Vent Oil Boiler

| Model | Item Number | Type* | Input MBH | Htg. Cap. MBH | AHRI Net MBH | Burner | Pump | AFUE% | Firing Rate GPH | Shp. Wgt. Lbs | Trade Price |
|------------|-----------------|-------|-----------|---------------|--------------|--------|------|-------|-----------------|---------------|-------------|
| GMOW-3085 | GMA308520210504 | C.O. | 119 | 103 | 90 | LESS | TACO | 86.0% | 0.85 | 534 | \$3,313 |
| GMOW-4125 | GMA412520210504 | C.O. | 175 | 152 | 132 | LESS | TACO | 86.0% | 1.25 | 668 | \$3,624 |
| GMOW-5160 | GMA516020210504 | C.O. | 224 | 195 | 170 | LESS | TACO | 86.0% | 1.60 | 781 | \$4,532 |
| GMOW-6185 | GMA618520210504 | C.O. | 259 | 226 | 197 | LESS | TACO | 86.0% | 1.85 | 901 | \$5,189 |
| GMOW-3085T | GMA308522210504 | T.C. | 119 | 103 | 90 | LESS | TACO | 86.0% | 0.85 | 534 | \$3,718 |
| GMOW-4125T | GMA412522210504 | T.C. | 175 | 152 | 132 | LESS | TACO | 86.0% | 1.25 | 668 | \$3,964 |
| GMOW-5160T | GMA516022210504 | T.C. | 224 | 195 | 170 | LESS | TACO | 86.0% | 1.60 | 781 | \$4,859 |
| GMOW-6185T | GMA618522210504 | T.C. | 259 | 226 | 197 | LESS | TACO | 86.0% | 1.85 | 901 | \$5,520 |

*TYPE (C.O. - CAST OVER) (T.C. - TANKLESS COIL)

GMOW (Use Equipment Multiplier for All of the Following)

| Model | Item Number | Description | Trade Price |
|-------|-------------|---------------------------------------|-------------|
| GMOW | 550004108 | GMOW-3 BECKETT BURNER IN A BOX KIT | \$1,184 |
| GMOW | 550004109 | GMOW-4 BECKETT BURNER IN A BOX KIT | \$1,184 |
| GMOW | 550004110 | GMOW-5 BECKETT BURNER IN A BOX KIT | \$1,184 |
| GMOW | 550004111 | GMOW-6 BECKETT BURNER IN A BOX KIT | \$1,184 |
| GMOW | 550004112 | GMOW-3/4/5 REILLO BURNER IN A BOX KIT | \$1,440 |
| GMOW | 550004113 | GMOW-6 REILLO BURNER IN A BOX KIT | \$1,641 |
| GMOW | 550004114 | GMOW-3/4 CARLIN BURNER IN A BOX KIT | \$1,184 |
| GMOW | 550004115 | GMOW-5/6 CARLIN BURNER IN A BOX KIT | \$1,184 |

GMSBO Cast-Iron Steam Boilers

- MBH Input 119 - 210 (CH)
- Up to 85.6% AFUE
- Dependable Cast Iron Heat Exchanger
- Honeywell Operating Control
- Burner swing door for easy serviceability
- Multiple Firing Rates
- Chimney Venting
- Optional tankless domestic hot water (DHW) coil



| General Information (See IOM for Complete Instructions) | | |
|---|---|---------|
| | SBO-3 | SBO-4 |
| Return/Supply Tappings | 1 1/4" Return NPT, 2" Supply NPT | |
| Oil | 3/8" O.D. Copper (runs 50' or less, 1/2" O.D. Copper (runs over 50') | |
| Electrical | 120 Volts AC, 60 hertz, 1 phase, less than 12 amps (15 amp circuit recommended) | |
| Water Content (Gallons) | 12 | 14.87 |
| Dimensions | A-Height | 35" |
| | B-Width | 22 1/8" |
| | C-Depth | 19 3/4" |

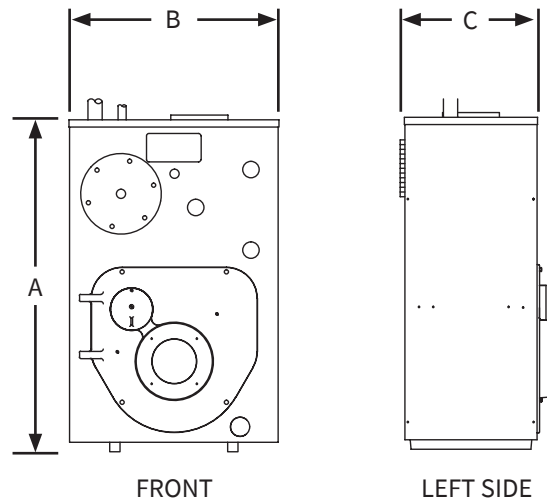

| GMSBO - Cast-Iron Chimney Vent Oil Boiler Less Burner | | | | | | | | | | |
|--|--------------------|------------------|----------------------|--------------------|---------------------|--------------|---------------|------------------------|----------------------|--------------------|
| Model | Item Number | Input MBH | Htg. Cap. MBH | Steam Sq Ft | AHRI Net MBH | AFUE% | Burner | Firing Rate GPH | Shp. Wgt. Lbs | Trade Price |
| SBO-3105 | SBO310521700104 | 147 | 127 | 396 | 95 | 85.0 | LESS | 1.05 | 538 | \$4,404 |
| SBO-4150 | SBO415021700104 | 210 | 180 | 563 | 135 | 85.0 | LESS | 1.50 | 650 | \$4,790 |

| GMSBO (Use Equipment Multiplier for All of the Following) | | | |
|--|--------------------|-------------------------------------|--------------------|
| Model | Item Number | Description | Trade Price |
| SBO | 550004158G | TANKLESS COIL WITH CONTROL | \$414 |
| SBO-3105 | 550004153G | GMSBO-3 BECKETT BURNER IN A BOX KIT | \$1,184 |
| SBO-4150 | 550004154G | GMSBO-4 BECKETT BURNER IN A BOX KIT | \$1,184 |

Please Note: Oil Fired Steam Boilers are sold less burner. Please add burner in a box kit to your order. Tankless Coil Kits are sold separately.

| GMSBO (Use Parts Multiplier for All of the Following) | | | |
|--|--------------------|------------------------------|--------------------|
| Model | Item Number | Description | Trade Price |
| SBO | 550004155 | 3085/3105 BECKETT RERATE KIT | \$166 |
| SBO | 550004156 | 4125/4150 BECKETT RERATE KIT | \$166 |



Conforms to UL STD 174
 Certified to CAN/CSA STD C22.2 No. 110-94

H2O GL Single Coil Glass Lined Indirect Water Heaters

- 31 - 106 Gallon Capacities
- Easy to Install
- Low Pressure Drop
- Magnesium Anode Rod (Corrosion Protection)
- Enameled Coated Steel Tank and Coil
- Minimal Standby Losses
- Flexible Scratch Resistant Jacket
- Aquastat Sensor Well
- Temperature Pressure Relief Valve



(H2O40GL Model Shown)

| General Information (See IOM for Complete Instructions) | | | | | |
|---|------------------------|---------------------|------------|--------|---------|
| Maximum Working Pressure: 150 psi for all Capacities | | | | | |
| Model | Piping Connections NPT | | Dimensions | | |
| | Domestic Water In/Out | Boiler Water In/Out | Diameter | Height | Weight |
| GMGL30 | 1" | 1" | 24" | 33" | 119 lbs |
| GMGL40I | 1" | 1" | 24" | 45" | 180 lbs |
| GMGL50I | 1" | 1" | 24" | 51" | 200 lbs |
| GMGL80I | 1" | 1" | 30" | 48" | 243 lbs |
| GMGL105I | 1" | 1" | 30" | 62" | 393 lbs |

H2O GL SERIES - Single Coil Glass Lined Indirect Water Heaters

| Model | Item Number | Storage Capacity gal | Type | Max. First Hour Rating gal/hr @ 115° F | Continuous Rating gal/hr @ 115° F | Boiler Output Req. BTU/hr | Shp. Wgt. lbs | Trade Price |
|----------|-------------|----------------------|-------------|--|-----------------------------------|---------------------------|---------------|-------------|
| GMGL30I | H2OIG30GM | 31 | GLASS LINED | 155 | 124 | 100,000 | 119 | \$1,487 |
| GMGL40I | H2OIG40GM | 42 | GLASS LINED | 198 | 162 | 120,000 | 180 | \$1,647 |
| GMGL50I | H2OIG50GM | 53 | GLASS LINED | 212 | 169 | 140,000 | 200 | \$1,854 |
| GMGL80I | H2OIG80GM | 79 | GLASS LINED | 228 | 164 | 180,000 | 243 | \$2,629 |
| GMGL105I | H2OIG105GM | 106 | GLASS LINED | 270 | 175 | 220,000 | 393 | \$4,093 |

H2O GL SERIES (Use Parts Multiplier for All of the Following)

| Model | Item Number | Description | Trade Price |
|-------------|-------------|--|-------------|
| 30-105 GAL. | 240010926 | T & P VALVE 3/4, 100XL-8 | \$62 |
| 30-105 GAL. | AQ-020.01 | AQUASTAT WELL | \$43 |
| 30-105 GAL. | 240013432 | AQUASTAT | \$171 |
| 30-50 GAL. | 240012211 | PLASTIC TOP CAP | \$34 |
| 80-105 GAL. | 240012239 | PLASTIC TOP CAP | \$47 |
| 40-105 GAL. | 240012212 | PLASTIC FRONT CAP | \$8 |
| 30 GAL. | 550003640 | ANODE KIT MAGNESIUM (INCLUDES ANODE, GASKET & BUSHING) | \$45 |
| 40-50 GAL. | 550003505 | ANODE KIT MAGNESIUM (INCLUDES ANODE, GASKET & BUSHING) | \$45 |
| 80-105 GAL. | 550003527 | ANODE KIT MAGNESIUM (INCLUDES ANODE, GASKET & BUSHING) | \$87 |
| 30 GAL. | 550003693 | ANODE KIT ALUMINUM (INCLUDES ANODE, GASKET & BUSHING) | \$44 |
| 40-50 GAL. | 550003694 | ANODE KIT ALUMINUM (INCLUDES ANODE, GASKET & BUSHING) | \$45 |
| 80-105 GAL. | 550003695 | ANODE KIT ALUMINUM (INCLUDES ANODE, GASKET & BUSHING) | \$87 |
| 30-50 GAL. | 240012250 | FLANGE CAP | \$47 |
| 80-105 GAL. | 240012251 | FLANGE CAP | \$18 |
| 30-50 GAL. | 240012210 | FLANGE GASKET | \$2 |
| 80-105 GAL. | 240012238 | FLANGE GASKET | \$4 |
| 40-50 GAL. | 550003510 | HARDWARE KIT (INCLUDES BOLTS & NUTS FOR FLANGE CAP) | \$4 |
| 80-105 GAL. | 550003525 | HARDWARE KIT (INCLUDES BOLTS & NUTS FOR FLANGE CAP) | \$4 |
| H2O 30 GL | 240012474 | OUTSIDE TANK COVER | \$126 |
| H2O 40 GL | 240012329 | OUTSIDE TANK COVER | \$128 |
| H2O 50 GL | 240012330 | OUTSIDE TANK COVER | \$137 |
| H2O 80 GL | 240012331 | OUTSIDE TANK COVER | \$149 |
| H2O 105 GL | 240012332 | OUTSIDE TANK COVER | \$167 |
| 30-50 GAL. | 240012483 | TEMPERATURE GAUGE | \$19 |
| 80-105 GAL. | 240012484 | TEMPERATURE GAUGE | \$27 |

TERMS & CONDITIONS OF SALE - GENERAL TERMS

PRICES & SPECIFICATIONS: All pricing and specifications subject to change without notice. The prices herein supersede all prior quotations.

ORDERS: Orders will be accepted based on prices in effect at the time the order is received. No order or contract will become an obligation on our part until accepted by the General Sales Department. ECR International shall not be liable for any delay or failure in the delivery or shipment of goods due to any cause or causes beyond its control.

TAXES: Add to the prices and terms quoted any manufacturers' or sales tax payable on the transaction under any effective statute.

SHIPMENTS

TRUCKLOADS: \$60,000 Net Order Value - Freight Prepaid. Indirect Water Heaters and Commercial Boiler lines can be added to any residential order for freight purposes. Authorized Distributors can combine Argo, Airco, Dunkirk, EMI, Olsen, Pennco, Utica Boilers and Utica Heating on one purchase order to earn free freight.

Stop off charges of \$200 will apply to stop off locations within 100 miles of the final destination. Please call for pricing for stop off special handling for a location further than 100 miles or for special handling pricing for services such as lift gate, unloading assistance, etc.

LESS THAN TRUCKLOAD SHIPMENT: F.O.B. ECR INTERNATIONAL - FACTORY OR WAREHOUSE

See Shipping and Delivery Policy for full details.

SALES ORDER INFORMATION CHECK LIST

The following information must be included on equipment or parts orders to insure proper shipment & invoicing:

- | | |
|--|--|
| 1) Purchase Order Number | 7) Pricing |
| 2) Bill to Address | 8) Product Description (Model, Size, etc.) |
| 3) Ship to Address | 9) Fuel Type (Oil, Natural Gas, Propane) |
| 4) Method of Shipment (trailer load, UPS) | 10) Electrical (Operating Voltage, Cycles, Phases, etc.) |
| 5) Requested Ship Date | 11) Non-Standard Equipment (Indicate "Optional" when substituted for standard equipment at extra cost listed. Indicate added to standard equipment.) |
| 6) Special Instructions ("Carrier to call...") | 12) Kits or Parts (Orders for kits or parts must indicate equipment size and series.) |

Send orders to:

E-mail: ecrorderentry@ecrinternational.com

Fax: (315) 724-9319

Please note the following Remit to Address:

ECR International, Inc.

P.O. Box 8000 Department 039

Buffalo, NY 14267

SHIPPING AND DELIVERY POLICY

| Shipping and Delivery Policy | |
|---------------------------------------|-------------------------------|
| Order Type / Value* | Freight Charges* |
| All UPS, Fed, Ex, DHL, etc. Shipments | Freight & Handling Cost Apply |
| \$0.00 - \$5,000 | Freight & Handling Cost Apply |
| \$5,001 - \$15,000 | \$350 |
| \$15,001 - \$59,999 | \$300 |
| \$60,000** | FFA |

*The above freight terms apply to single purchase orders or combined purchase orders from one company with one stop totaling the above reference tiers. Additional stops will incur additional charges. Pooling from multiple companies is not allowed under this freight program.

**Orders of \$60,000 or more from one company with multiple stops will incur a \$200 stop-off charge per stop after the initial stop. Each stop location must be within 100 miles of the initial stop or additional charges will apply.

Because of packaging and shipping constraints, EMI products do not qualify for this freight program unless prior approval is obtained from your Regional Sales Manager.

Except for FFA qualifying orders, the above US shipping rates apply to shipments east of the Mississippi River. If shipments are beyond that area actual freight rates will apply.

These rates apply to destinations where no special delivery requirements are needed. Additional charges will apply when special handling and delivery is incurred. Pre-shipment notification of any special shipping or handling provisions is required. Unless otherwise noted, all products will be shipped FOB Shipping Point and transfer of ownership and responsibility is assumed by the customer for all loss or damage. ECR International will not be held liable for any damage, loss or costs which occur due to shipping delay. ECR retains the right to change or alter this program without notice and without penalty.

Family bundling is encouraged; boilers, furnaces, A/C, and controls can be combined to achieve freight tiers.

If you have any questions, please contact your ECR representative or ECR Regional Manager.

U.S. DISTRIBUTOR - RETURN MATERIAL POLICY (RMA)

Prior Approval Required - All returns for exchange, credit, repair service or warranty claim must be approved by ECR International and require an RMA number prior to return of the material. A request must be completed via the online web portal. Please log on to www.ecrcustomerportal.com to complete your request for return. If you do not already have access to the customer web portal, please contact ECR International Customer Service at 1-800-325-5479 to be set-up.

Eligibility - An RMA Request must be received within 60 days from the date of invoice for returns of New & Unused product in original packaging. A restocking fee of 15% will be charged for all new and unused returns that are approved for return. Special Order Products (items not offered as standard in ECR International trade price book) are not eligible for return as new and unused product. Request for Warranty Returns must be made within the period covered by the warranty and must fall under the terms and conditions specified in the warranty.

Repair Service - Request for repair or rework of product damaged by customer is classified as Repair Service. Repair Service is billed at \$75.00 per hour for labor and net price for parts used in repair/rework. ECR International's Return Material (RM) department will evaluate the items returned for repair service. The customer will receive an estimate for the dollar amount, determined by ECR International's RM department, required to complete the repairs requested. A Purchase Order (PO) from the customer for that amount will be required before any work is performed.

RMA Expiration Parts - Once the RMA number is issued, the product must be returned within 60 days of the RMA date, or the RMA will be canceled. Products approved for return that are received after 60 days from the RMA date will not be accepted.

Shipping & Packaging - All returns must have a valid RMA number clearly displayed on the exterior of the package or the package will not be accepted. All returns of new and unused product must be in the original packaging. All returns must be shipped prepaid by the customer unless otherwise directed by ECR as indicated on the RMA Verification. Ship all approved return material to the facility indicated on the approved RMA Request by the date indicated.

Replacement Product - If replacement product is desired it must be indicated on the RMA Request. A PO# is required for the replacement shipment and must be indicated on the RMA Request. All replacement products will be invoiced at the time of shipment. ECR will pay the ground freight for all warranty replacements.

Application of Credit - Credit for returned product will be applied to the customer's account (less restocking fees for New and Unused returns) only after confirmation of receipt by ECR and inspection of the product. Issuance of a credit for a partial return of product does not relieve the customer from the obligation to remit payment for the merchandise not returned in accordance with the payment terms referenced on the customer's invoice(s). Customer will have the option to have any product that is denied for credit returned at their expense.

Returning Installed Finished Goods (Complete boilers, furnaces, A/C units etc.)

- Equipment that is already installed should be repaired not replaced. Exceptions: leaking cast iron boilers in their first year or leaking water tanks. Leaking drain valves on water tanks are replaceable, make sure the leak is not on the valve. Tanks returned with the only leak being on the valve will be denied.
- Cast iron blocks (not complete boilers) older than one year and Indirect tanks that are leaking do not require prior approval. Simply type "Leaking" into the Authorization field and it will be accepted. Complete Cast iron boilers within their first year will still require prior authorization for full boiler replacement.
- Water leaks on copper and condensing boilers are repairable and will require prior authorization for any reason for removal.
- To guarantee credit, if a situation arises where equipment does need to be replaced, **prior authorization** from ECR is required. This will ensure that ECR has visibility to the problem and has had an opportunity to correct it prior to removal. *All equipment considered for removal should first be brought to the attention of Technical Support at 1-800-253-7900.*
- If approved, an authorization number will be given that will need to be entered in the RMA on the Customer Portal.
- For equipment that is removed from service without prior authorization by ECR, contact Customer Service. They will evaluate the circumstance and can issue a conditional RMA. The equipment will be tested in our lab to determine if removal was warranted and if credit will be given.

RMA Expiration Equipment - Once the RMA number is issued, the product must be returned within 30 days of the RMA date, or the RMA will be canceled. Products approved for return that are received after 30 days from the RMA date will not be accepted.

