



# Green Mountain

BOILERS

## US Trade Price Book - 2021

*Effective 1/1/21*



As rugged as the outdoors...  
for dependable comfort every day

[www.greenmountainboilers.com](http://www.greenmountainboilers.com)



Manufactured by:  
ECR International Inc.  
2201 Dwyer Avenue, Utica, NY 13501  
Tel. 800 325 5479  
[www.ecrinternational.com](http://www.ecrinternational.com)  
PN 240011133 REV. J [01/01/2021]



## CUSTOMER SUPPORT TEAM

---

### **CUSTOMER SERVICE:**

Phone: (800) 325-5479 option #2  
Fax: (315) 724-9319  
Email Purchase Orders: [ecrorderentry@ecrinternational.com](mailto:ecrorderentry@ecrinternational.com)  
Email Inquiries: [customerservice@ecrinternational.com](mailto:customerservice@ecrinternational.com)

### **TECHNICAL SUPPORT:**

Phone: (800) 253-7900  
Fax: (866) 432-7329  
Email: [technical.support@ecrinternational.com](mailto:technical.support@ecrinternational.com)

### **MARKETING SUPPORT:**

Phone: (800) 325-5479  
Fax: (315) 733-1759  
E-mail: [marketing@ecrinternational.com](mailto:marketing@ecrinternational.com)

### **[WWW.ECRCUSTOMERPORTAL.COM](http://WWW.ECRCUSTOMERPORTAL.COM)**

#### **Your On-line Access to:**

- Order Status
- Invoices
- Statements
- RMA
- Serial Number Look-Up
- Literature

## Table of Contents

<b><u>Condensing Natural / LP Boilers</u></b>		<b><u>4-5</u></b>
<b>GMHB/GMCB</b>	Stainless Steel Combi & Heating Boilers (122-379 MBH)	<b>4</b>
<b><u>Venting</u></b>		<b><u>6-9</u></b>
<b>VENTING</b>	Coaxial, Twin Pipe & CPVC Venting for Condensing Boilers	<b>6</b>
<b><u>Natural / LP Boilers</u></b>		<b><u>10-15</u></b>
<b>GMGW</b>	Cast-Iron Chimney Vented Boilers (59-235 MBH)	<b>10</b>
<b>GMPVB</b>	Cast-Iron Induced Draft Chimney/Side Wall Vented Boilers (42-187 MBH)	<b>12</b>
<b>GMGS</b>	Cast-Iron Steam Boilers (75-299 MBH)	<b>14</b>
<b><u>Oil Boilers</u></b>		<b><u>16-19</u></b>
<b>GMOW</b>	Cast-Iron Chimney Vented Boilers (119-259 MBH)	<b>16</b>
<b>GMOS</b>	Cast-Iron Steam Boilers (119-210 MBH)	<b>18</b>
<b><u>Indirect Tanks</u></b>		<b><u>20-21</u></b>
<b>H2O GL</b>	Single Coil Glass Lined Indirect Water Heaters (31-106 GALS)	<b>20</b>
<b><u>Terms &amp; RMA Policy</u></b>		<b><u>22-23</u></b>



## GMHB / GMCB Stainless Steel Combi & Heating Boilers

- MBH Input 122 - 379 (CH) / 147 - 200 (DHW)
- 95% AFUE - Recognized as ENERGY STAR® Most Efficient 2021 (95% Thermal Efficiency GMHB-380)
- Up to 6.25:1 Turndown Ratio
- 3.4 gpm DHW (GMCB-150) @ 70°F Rise  
4.9 gpm DHW (GMCB-200) @ 70°F Rise
- Stainless Steel Primary Heat Exchanger



General Information (See IOM for Complete Instructions)						
Model	GMHB-125	GMCB-150	GMHB-160	GMCB-200	GMHB-227	GMHB-380
Water Return/Supply	1" NPT		1" NPT		1 1/4" NPT	1 1/2" NPT
Gas	3/4" NPT		3/4" NPT		3/4" NPT	1" NPT
Condensate Trap	3/4" NPT		3/4" NPT		3/4" NPT	
DHW Outlet (125 Optional)	3/4" NPT		3/4" NPT		NA	
DHW (Cold Water) Inlet	3/4" NPT		3/4" NPT		NA	
Electrical	120 Volts AC, 60 hertz, 1 phase, less than 12 amps (15 amp circuit recommended)					
Water Content (Gallons)	1		1 1/4		1 1/4	4.6
Dimensions	A-Height	30"		30"		37 7/16"
	B-Width	17 3/4"		17 3/4"		23 5/8"
	C-Depth	14"		23"		25 3/8"
Weight	102 lbs	103 lbs	125 lbs	125 lbs	120	225

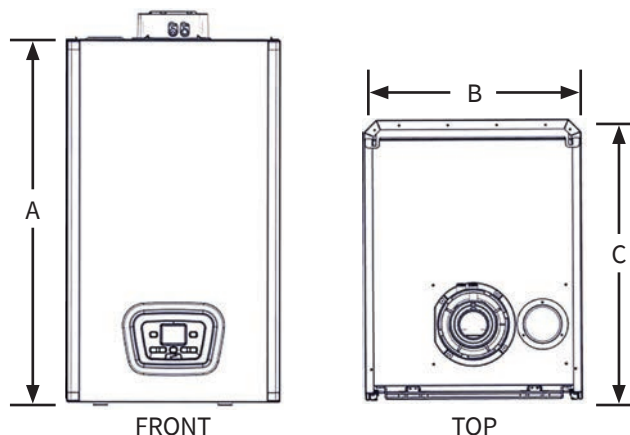















<b>GMHB/GMCB - Stainless Steel Combi &amp; Heating Boilers</b>									
<b>Model</b>	<b>Item Number</b>	<b>Type</b>	<b>Input MBH CH/DHW</b>	<b>AHRI Net MBH</b>	<b>Fuel</b>	<b>AFUE%</b>	<b>Pump</b>	<b>Shp. Wgt. lbs</b>	<b>Trade Price</b>
GMHB125	ECR112203800104	HEATING	126	97	NAT/LP	95	LESS	102	\$3,085
GMHB165	ECR116003800104	HEATING	164	129	NAT/LP	95	LESS	125	\$3,670
GMHB227	ECR122703800104	HEATING	227	183	NAT/LP	95	LESS	120	\$7,210
GMHB380	ECR138003800104	HEATING	379	303	NAT/LP	95	LESS	225	\$10,640
GMCB150	ECR114703800104	COMBI	126/153	97	NAT/LP	95	LESS	103	\$3,321
GMCB205	ECR120003800104	COMBI	164/205	129	NAT/LP	95	LESS	125	\$3,844

















**GMHB/GMCB (Use Parts Multiplier for All of the Following)**

<b>Model</b>	<b>Item Number</b>	<b>Description</b>	<b>Trade Price</b>
GMHB/CB	BD710487302V	OUTSIDE AIR SENSOR	\$36
GMHB/CB	550003189	DHW SENSOR KIT	\$78
GMHB/CB	550003332	CSD-1 KIT (INCLUDES HIGH LIMIT AND MANUAL REST LWCO)	\$498
GMHB125	550003506	GMHB125/GMCB150 NATURAL GAS TO LP GAS CONVERSION KIT	\$22
GMHB160	550003507	GMHB160 NATURAL GAS TO LP GAS CONVERSION KIT	\$22
GMCB200	550003546	GMCB200 NATURAL GAS TO LP GAS CONVERSION KIT	\$22
GMHB227	550003508	GMHB227 NATURAL GAS TO LP GAS CONVERSION KIT	\$126
GMHB380	550003509	GMHB380 NATURAL GAS TO LP GAS CONVERSION KIT	\$126
GMHB/CB	240010266	FLOOR STAND KIT	\$648
GMHB/CB	550003212	HEAT EXCHANGER CLEANING KIT	\$54



## VENTING

					Coaxial Venting		
125/150	160/200	GMHB227	GMHB380	Image	Item Number	Description	Trade Price
X					KUG714059511	2"x4" (60/100mm)COAXIAL PIPE 3.28' (1m) L	\$40
X					KUG714059611	2"x4" (60/100mm)HORIZONTAL VENT TERM	\$49
X					KUG714059711	2"x4" (60/100mm)COAXIAL 90 ELBOWS	\$30
X					KUG714059811	2"x4" (60/100mm)COAXIAL 45 ELBOWS	\$30
X					KUG714135813	2"x4" (60/100mm)VERTICAL VENT TERM	\$117
	X	X			KHG714088512	3"x5" (80/125mm)COAXIAL PIPE 3.28' (1m) L	\$58
	X	X			KHG714088713	3"x5" (80/125mm)COAXIAL 90 ELBOWS	\$31
	X	X			KHG714088812	3"x5" (80/125mm)COAXIAL 45 ELBOWS	\$31
	X	X			KHG714088911	3"x5" (80/125mm)HORIZONTAL VENT TERM	\$66
	X	X			KHG714093512	3"x5" (80/125mm)VERTICAL VENT TERM	\$91
			X		KUG714133311	4"x6" (110/160mm)HORIZONTAL VENT TERM	\$242
			X		KUG714133411	4"x6" (110/160mm)VERTICAL VENT TERM	\$307
			X		KUG714133511	4"x6" (110/160mm)COAXIAL 45 ELBOWS	\$85
			X		KUG714133611	4"x6" (110/160mm)COAXIAL 90 ELBOWS	\$85
			X		KUG714133811	4"x6" (110/160mm)COAXIAL PIPE 3.28' (1m) L	\$118

## VENTING

					Twin Pipe Polypropylene Venting		
125/150	160/200	GMHB227	GMHB380	Image	Item Number	Description	Trade Price
X					KHG714059113	2" (60/100mm)CONCENTRIC TO TWIN PIPE ADAPTER	\$17
X	X	X			550003416	3" (80mm)VENTING CLAMP SINGLE WALL	\$37
X	X	X			550003452	3" (80mm)CLAMSHELL CLAMP (5PK)	\$36
X	X	X			KUG714132010	3" (80mm)HORIZONTAL VENT TERM	\$20
X	X	X			KUG714132110	3" (80mm)VERTICAL VENT TERM	\$48
X	X	X			550003734	3" (80mm)POLYPROPYLENE 45 ELBOWS W/ CLAMP	\$15
X	X	X			550003735	3" (80mm)POLYPROPYLENE 90 ELBOWS W/ CLAMP	\$15
X	X	X			550003767	3" (80mm)POLYPROPYLENE PIPE 3.28' (1m) L W/ CLAMP	\$22
	X	X			KHG714089010	3" (80/125mm)CONCENTRIC TO TWIN PIPE ADAPTER	\$40
		X			550003453	4" (110mm)CLAMSHELL CLAMP (5PK)	\$48
		X			BD7106314V	4" (110/160mm)CONCENTRIC TO TWIN PIPE ADAPTER	\$128
		X			KUG714132710	4" (110mm)HORIZONTAL VENT TERM	\$123
		X			KUG714132810	4" (110mm)VERTICAL VENT TERM	\$112
		X			550003731	4" (110mm)POLYPROPYLENE 45 ELBOWS W/ CLAMP	\$32
		X			550003732	4" (110mm)POLYPROPYLENE 90 ELBOWS W/ CLAMP	\$32
		X			550003733	4" (110mm)POLYPROPYLENE PIPE 3.28' (1m) L W/ CLAMP	\$45

## VENTING

Twin Pipe CPVC Venting					Image	Item Number	Description	Trade Price
125/150	160/200	GMHB227	GMHB380	X		550003184	TWIN PIPE ADAPTER 60MM TO CPVC 3"	\$58
	X	X			550003403	TWIN PIPE ADAPTER 80MM TO CPVC 3"	\$108	



**This page is intentionally left blank,  
products continue on the following page.**



# GMGW Cast-Iron Chimney Vented Boilers

- MBH Input 59 - 235 (CH)
- 84% AFUE
- Dependable Cast Iron Heat Exchanger
- Honeywell Control
- Digital temperature display and diagnostics
- Built-In Low Water Cut-Off (LWCO)
- Control monitors water temperature and delays burner start until residual heat has been transferred to the system for maximum efficiency.
- Low Profile draft hood diverter



General Information (See IOM for Complete Instructions)							
	GMGW-060K	GMGW-095K	GMGW-120K	GMGW-150K	GMGW-175K	GMGW-205K	GMGW-235K
Water Return/Supply	1 1/4" NPT						
Gas	1/2" NPT				3/4" NPT		
Electrical	120 Volts AC, 60 hertz, 1 phase, less than 12 amps (15 amp circuit recommended)						
Water Content (Gallons)	1.9	2.3	2.8	3.2	3.7	4.1	4.6
A-Height	32 1/8"	32 1/8"	32 1/8"	32 1/8"	32 1/8"	32 1/8"	32 1/8"
B-Width	13 3/8"	13 3/8"	16 1/4"	19"	21 7/8"	27 1/2"	27 1/2"
C-Depth	24 1/8"	24 1/8"	24 1/8"	24 1/8"	24 1/8"	24 1/8"	24 1/8"
Weight	215	250	295	335	385	420	465

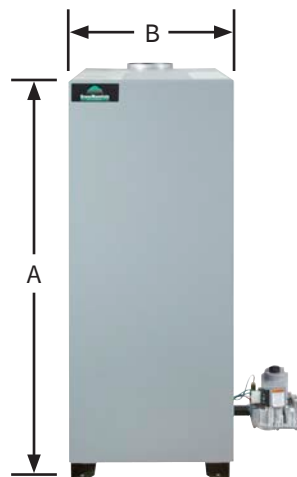

FRONT



RIGHT SIDE

**GMGW - Cast-Iron Chimney Vented Boilers**

Model	Item Number	Fuel	Input MBH	Htg. Cap. MBH	AHRI Net MBH	AFUE %	Pump	Shp. Wgt. lbs	No. of Brns.	Trade Price
GMGW-060K	15B306003710304	NAT	59	50	43	84.0	TACO	215	1	\$2,117
GMGW-095K	15B409503710304	NAT	92.5	78	68	84.0	TACO	250	2	\$2,318
GMGW-120K	15B512003710304	NAT	120	101	88	84.0	TACO	295	2	\$2,491
GMGW-150K	15B615003710304	NAT	149	125	109	84.0	TACO	335	3	\$2,782
GMGW-175K	15B717503710304	NAT	175	148	129	84.0	TACO	385	3	\$3,063
GMGW-205K	15B820503710304	NAT	205	172	150	84.0	TACO	420	4	\$3,441
GMGW-235K	15B923503710304	NAT	235	197	172	84.0	TACO	465	4	\$3,745

**GMGW (Use Parts Multiplier for All of the Following)**

Model	Item Number	Description	Trade Price
GMGW-K	550003778	NATURAL GAS TO LP GAS CONVERSION KIT	\$74
GMGW-K	550003884	LP GAS TO NATURAL GAS CONVERSION KIT	\$81



# GMPVB Cast-Iron Induced Draft Chimney/Side Wall Vented Boilers

- MBH Input 42.5 - 187.5 (CH)
- Up to 84.4% AFUE
- Dependable Cast Iron Heat Exchanger with Cast Iron Push Nipples
- Honeywell High Limit/Electronic Ignition Control
  - Recessed under the boiler's protective jacket
  - Digital Temperature display and diagnostics
  - Plug in connection for the inducer fan
  - Plug in connection for the system pump
- Induced Draft Fan



General Information (See IOM for Complete Instructions)						
Model	GMPVB-42	GMPVB-75	GMPVB-112	GMPVB-150	GMPVB-188	
Water Return/Supply	1 1/4" NPT					
Gas	1/2" NPT					
Electrical	120 Volts AC, 60 hertz, 1 phase, less than 12 amps (15 amp circuit recommended)					
Water Content (Gallons)	1.75	3.00	4.25	5.50	6.75	
Dimensions	A-Height	29"	29"	29"	29"	
	B-Width	11"	14 1/4"	17 1/2"	20 3/4"	24"
	C-Depth	23 1/4"	23 1/4"	23 1/4"	23 1/4"	23 1/4"
Weight	225 lbs	265 lbs	322 lbs	370 lbs	431 lbs	

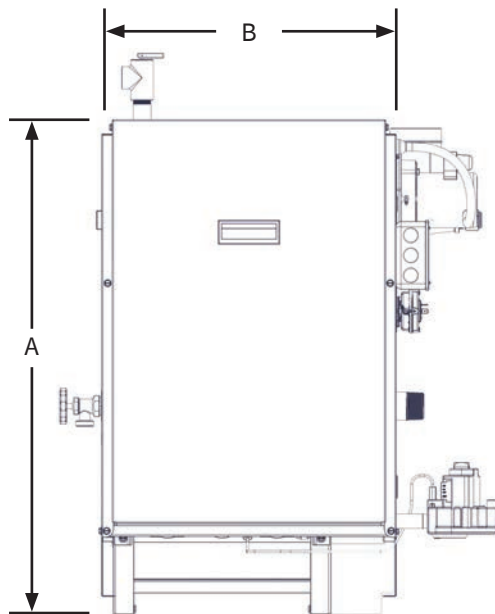

FRONT

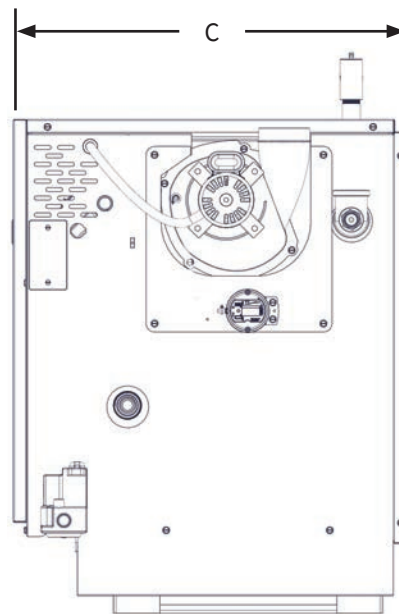

RIGHT SIDE

**GMPVB - Cast-Iron Induced Draft Chimney/Side Wall Vented Boilers**

Model	Item Number	Fuel	Input MBH	Htg. Cap. MBH	AHRI Net MBH	Pump	AFUE%	Shp. Wgt. Lbs	Chimney Cat. I	Side Wall Cat. III	Trade Price
GMPVB-42	FSB204203110304	NAT	42.5	36	31	TACO	84.4	225	4"	3"	\$2,259
GMPVB-75	FSB307503110304	NAT	75	63	55	TACO	84.0	265	4"	3"	\$2,548
GMPVB-112	FSB411203110304	NAT	112.5	95	82	TACO	84.0	322	4"	3"	\$2,810
GMPVB-150	FSB515003110304	NAT	150	127	109	TACO	84.0	370	4"	3"	\$3,145
GMPVB-188	FSB618703110304	NAT	187.5	158	135	TACO	84.0	431	4"	4"	\$3,682

**GMPVB (Use Parts Multiplier for All of the Following)**

Model	Item Number	Description	Trade Price
GMPVB	550002722	NATURAL TO LP CONVERSION KIT (ALL SIZES)	\$91
GMPVB	43300660	LP TO NATURAL CONVERSION KIT (ALL SIZES)	\$100
GMPVB	14629010	TJERNLUND VH-1-3" SIDE WALL VENT HOOD (GMPVB-2 TO GMPVB-5)	\$253
GMPVB	14629011	TJERNLUND VH-1-4" SIDE WALL VENT HOOD (GMPVB-6)	\$301

## GMGS Cast-Iron Steam Boilers

- MBH Input 75 - 299 (CH)
- Up to 82.7% AFUE
- 7 Sizes Available
- Dependable Cast-Iron Heat Exchanger
- Electronic Ignition System
- Automatic Vent Damper
- LWCO (Probe Type) externally mounted for quick access
- Pressure High Limit Control with Pressure Gauge and Gauge Glass
- Stainless Steel Burners
- Easy Serviceability



General Information (See IOM for Complete Instructions)							
Model	GMGS075E	GMGS112E	GMGS150E	GMGS187E	GMGS225E	GMGS262E	GMGS299E
Steam Return/Supply	2 1/2" NPT						
Electrical	120 Volts AC, 60 hertz, 1 phase, less than 12 amps (15 amp circuit recommended)						
A-Height	36.375"	36.375"	36.375"	36.375"	36.375"	36.375"	36.375"
B-Width	11 1/4"	14 1/2"	17 3/4"	21"	24 1/4"	27 1/2"	30 3/4"
C-Depth	26 1/2"	26 1/2"	26 1/2"	26 1/2"	26 1/2"	26 1/2"	26 1/2"
Weight	297	368	440	512	584	659	736

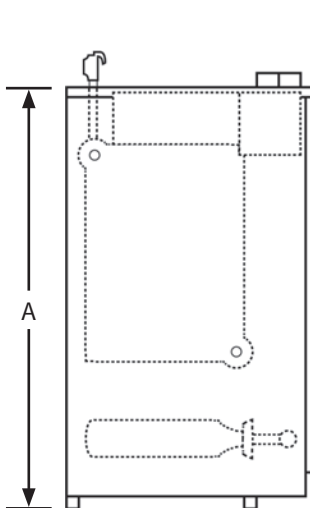

LEFT SIDE

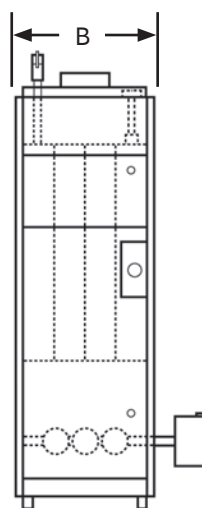

FRONT

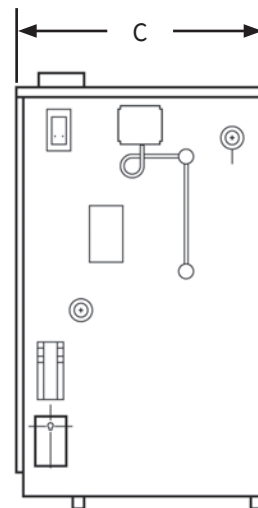

RIGHT SIDE

<b>GMGS SERIES - Cast-Iron Steam Boiler</b>									
<b>Model</b>	<b>Item Number</b>	<b>Fuel</b>	<b>Input MBH</b>	<b>Htg. Cap. MBH</b>	<b>AHRI Net MBH</b>	<b>AHRI Net SQ. FT. Steam</b>	<b>AFUE%</b>	<b>Shp. Wgt. lbs</b>	<b>Trade Price</b>
GMGS075E	16B307503100204	NAT	75	62	47	195	82.7%	297	\$2,546
GMGS112E	16B411203100204	NAT	112	91	68	283	82.0%	368	\$2,848
GMGS150E	16B515003100204	NAT	150	122	92	383	82.0%	440	\$3,182
GMGS187E	16B618703100204	NAT	187	153	115	479	82.0%	512	\$3,637
GMGS225E	16B722503100204	NAT	225	183	137	570	82.0%	584	\$4,061
GMGS262E	16B826203100204	NAT	262	214	161	670	82.0%	659	\$4,487
GMGS299E	16B929903100204	NAT	299	245	184	766	82.0%	736	\$4,780

<b>GMGS SERIES (Use Parts Multiplier for All of the Following)</b>			
<b>Model</b>	<b>Item Number</b>	<b>Description</b>	<b>Trade Price</b>
GMGS075E	43300723	3 SECTION NATURAL GAS TO LP GAS CONVERSION KIT	\$54
GMGS112E	43300724	4 SECTION NATURAL GAS TO LP GAS CONVERSION KIT	\$54
GMGS150E	43300725	5 SECTION NATURAL GAS TO LP GAS CONVERSION KIT	\$54
GMGS187E	43300726	6 SECTION NATURAL GAS TO LP GAS CONVERSION KIT	\$64
GMGS225E	43300727	7 SECTION NATURAL GAS TO LP GAS CONVERSION KIT	\$64
GMGS262E	43300728	8 SECTION NATURAL GAS TO LP GAS CONVERSION KIT	\$64
GMGS299E	43300729	9 SECTION NATURAL GAS TO LP GAS CONVERSION KIT	\$64
GMGS112E	43300632	4 SECTION LP GAS TO NATURAL GAS CONVERSION KIT	\$202
GMGS150E	43300633	5 SECTION LP GAS TO NATURAL GAS CONVERSION KIT	\$205
GMGS187E	43300634	6 SECTION LP GAS TO NATURAL GAS CONVERSION KIT	\$200
GMGS225E	43300635	7 SECTION LP GAS TO NATURAL GAS CONVERSION KIT	\$202
GMGS262E	43300636	8 SECTION LP GAS TO NATURAL GAS CONVERSION KIT	\$203
GMGS299E	43300637	9 SECTION LP GAS TO NATURAL GAS CONVERSION KIT	\$203
GMGS	1630001	MCDONNELL & MILLER WF-2U-24 ELECTRONIC WATER FEEDER	\$512

## GMOW Cast-Iron Chimney Vent Boilers

- MBH Input 119 - 259 (CH)
- Up to 87% AFUE
- Dependable Cast Iron Heat Exchanger with Cast Iron Push Nipples
- Hydrolevel Operating Control
  - Digital Temperature display and diagnostics
  - Adjusts water temperature based on heating system demand
  - Built-In Low Water Cut-Off (LWCO)
  - Boiler Reset
- Burner swing door for easy serviceability
- Multiple Firing Rates
- Optional tankless domestic hot water (DHW) coil



General Information (See IOM for Complete Instructions)					
GMOW	3085(T)	4100(T)	4125(T)	5160(t)	6185(T)
Water Return/Supply	1 1/2" Return NPT, 2" Supply NPT				
Oil	3/8" O.D. Copper (runs 50' or less, 1/2" O.D. Copper (runs over 50')				
Electrical	120 Volts AC, 60 hertz, 1 phase, less than 12 amps (15 amp circuit recommended)				
Water Content (Gallons)	10.5	13.5	13.5	16.5	19.5
Dimensions	A-Height	35"	35"	35"	35"
	B-Width	21 13/16"	21 13/16"	21 13/16"	21 13/16"
	C-Depth	17 7/8"	21 1/2"	21 1/2"	25 1/8"
Weight	534	668	668	781	901

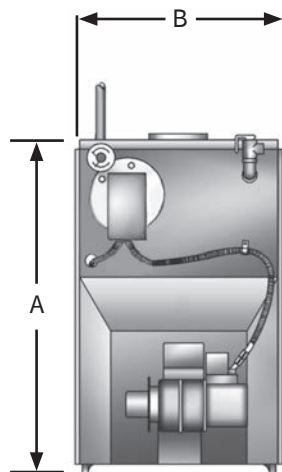

FRONT

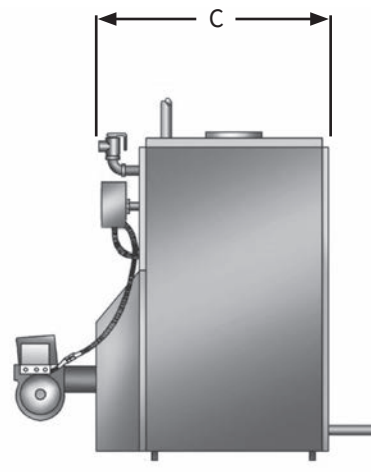

RIGHT SIDE



**GMOW - Cast-Iron Chimney Vent Oil Boiler**

Model	Item Number	Type*	Input MBH	Htg. Cap. MBH	AHRI Net MBH	Burner	Pump	AFUE%	Firing Rate GPH	Shp. Wgt. Lbs	Trade Price
GMOW-3085	GMA308520210504	C.O.	119	103	90	LESS	TACO	86.0%	0.85	534	\$2,477
GMOW-4125	GMA412520210504	C.O.	175	152	132	LESS	TACO	86.0%	1.25	668	\$2,709
GMOW-5160	GMA516020210504	C.O.	224	195	170	LESS	TACO	86.0%	1.60	781	\$3,388
GMOW-6185	GMA618520210504	C.O.	259	226	197	LESS	TACO	86.0%	1.85	901	\$3,880
GMOW-3085T	GMA308522210504	T.C.	119	103	90	LESS	TACO	86.0%	0.85	534	\$2,780
GMOW-4125T	GMA412522210504	T.C.	175	152	132	LESS	TACO	86.0%	1.25	668	\$2,963
GMOW-5160T	GMA516022210504	T.C.	224	195	170	LESS	TACO	86.0%	1.60	781	\$3,634
GMOW-6185T	GMA618522210504	T.C.	259	226	197	LESS	TACO	86.0%	1.85	901	\$4,127

\*TYPE (C.O. - CAST OVER) (T.C. - TANKLESS COIL)

**GMOW (Use Equipment Multiplier for All of the Following)**

Model	Item Number	Description	Trade Price
GMOW	550004108	GMOW-3 BECKETT BURNER IN A BOX KIT	\$886
GMOW	550004109	GMOW-4 BECKETT BURNER IN A BOX KIT	\$886
GMOW	550004110	GMOW-5 BECKETT BURNER IN A BOX KIT	\$886
GMOW	550004111	GMOW-6 BECKETT BURNER IN A BOX KIT	\$886
GMOW	550004112	GMOW-3/4/5 REILLO BURNER IN A BOX KIT	\$1,076
GMOW	550004113	GMOW-6 REILLO BURNER IN A BOX KIT	\$1,227
GMOW	550004114	GMOW-3/4 CARLIN BURNER IN A BOX KIT	\$886
GMOW	550004115	GMOW-5/6 CARLIN BURNER IN A BOX KIT	\$886

**GMOW (Use Parts Multiplier for All of the Following)**

Model	Item Number	Description	Trade Price
GMOW 3 SEC	550003611	GMOW3 TANKLESS COIL KIT P3	\$348
GMOW 4-6 SEC	550003612	GMOW4-6 TANKLESS COIL KIT	\$414

# GMOS Cast-Iron Steam Boilers

- MBH Input 119 - 210 (CH)
- Up to 85.6% AFUE
- Dependable Cast Iron Heat Exchanger
- Honeywell Operating Control
- Burner swing door for easy serviceability
- Multiple Firing Rates
- Chimney Venting
- Optional tankless domestic hot water (DHW) coil



General Information (See IOM for Complete Instructions)				
GMOS	SBO-3085	SBO-3105	SBO-4125	SBO-4150
Return/Supply Tappings	1 1/4" Return NPT, 2" Supply NPT			
Oil	3/8" O.D. Copper (runs 50' or less, 1/2" O.D. Copper (runs over 50')			
Electrical	120 Volts AC, 60 hertz, 1 phase, less than 12 amps (15 amp circuit recommended)			
Water Content (Gallons)	12	12	14.87	14.87
Dimensions	A-Height	35"	35"	35"
	B-Width	22 1/8"	22 1/8"	22 1/8"
	C-Depth	15 3/4"	15 3/4"	19 3/4"
Weight	570 lbs.	570 lbs.	685 lbs.	685 lbs.

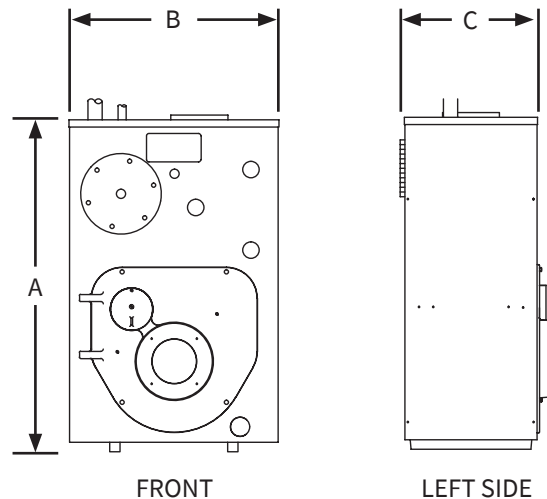

**GMOS Series 2 - Cast-Iron Chimney Vent Oil Boiler Less Burner**

Model	Item Number	Input MBH	Htg. Cap. MBH	Steam Sq Ft	AHRI Net MBH	AFUE%	Burner	Firing Rate GPH	Shp. Wgt. Lbs	Trade Price
SBO-3105	SBO310521700104	147	127	396	95	85.0	LESS	1.05	688	\$3,292
SBO-4150	SBO415021700104	210	180	563	135	85.0	LESS	1.50	901	\$3,582

**GMOS Series 2 (Use Equipment Multiplier for All of the Following)**

Model	Item Number	Description	Trade Price
SBO	550004158G	TANKLESS COIL WITH CONTROL	\$310
SBO-3105	550004153G	SBO-3105 BECKETT BURNER IN A BOX KIT	\$886
SBO-4150	550004154G	SBO-4150 BECKETT BURNER IN A BOX KIT	\$886

**Please Note: Oil Fired Steam Boilers are sold less burner. Please add burner in a box kit to your order. Tankless Coil Kits are sold separately.**

**GMOS Series 2 (Use Parts Multiplier for All of the Following)**

Model	Item Number	Description	Trade Price
SBO	550004155	3085/3105 BECKETT RERATE KIT	\$126
SBO	550004156	4125/4150 BECKETT RERATE KIT	\$126



Conforms to UL STD 174  
 Certified to CAN/CSA STD C22.2 No. 110-94

## H2O GL Single Coil Glass Lined Indirect Water Heaters

- 31 - 106 Gallon Capacities
- Easy to Install
- Low Pressure Drop
- Magnesium Anode Rod Corrosion Protection
- Enameled Coated Steel Tank and Coil
- Minimal Standby Losses
- Flexible Scratch Resistant Jacket
- Aquastat Sensor Well
- Temperature Pressure Relief Valve



(H2O40GL Model Shown)

General Information (See IOM for Complete Instructions)					
Maximum Working Pressure: 150 psi for all Capacities					
Model	Piping Connections NPT		Dimensions		
	Domestic Water In/Out	Boiler Water In/Out	Diameter	Height	Weight
GMGL30	1"	1"	24"	33"	119 lbs
GMGL40I	1"	1"	24"	45"	180 lbs
GMGL50I	1"	1"	24"	51"	200 lbs
GMGL80I	1"	1"	30"	48"	243 lbs
GMGL105I	1"	1"	30"	62"	393 lbs

**H2O GL SERIES - Single Coil Glass Lined Indirect Water Heaters**

Model	Item Number	Storage Capacity gal	Type	Max. First Hour Rating gal/hr @ 115° F	Continuous Rating gal/hr @ 115° F	Boiler Output Req. BTU/hr	Shp. Wgt. lbs	Trade Price
GMGL30I	H2OIG30GM	31	GLASS LINED	155	124	100,000	119	\$1,142
GMGL40I	H2OIG40GM	42	GLASS LINED	198	162	120,000	180	\$1,266
GMGL50I	H2OIG50GM	53	GLASS LINED	212	169	140,000	200	\$1,424
GMGL80I	H2OIG80GM	79	GLASS LINED	228	164	180,000	243	\$2,019
GMGL105I	H2OIG105GM	106	GLASS LINED	270	175	220,000	393	\$3,144

**H2O GL SERIES (Use Parts Multiplier for All of the Following)**

Model	Item Number	Description	Trade Price
30-105 GAL.	240010926	T & P VALVE 3/4, 100XL-8	\$47
30-105 GAL.	AQ-020.01	AQUASTAT WELL	\$32
30-105 GAL.	240009521	AQUASTAT L4080B1352	\$130
30-50 GAL.	240012211	PLASTIC TOP CAP	\$26
80-105 GAL.	240012239	PLASTIC TOP CAP	\$36
40-105 GAL.	240012212	PLASTIC FRONT CAP	\$8
30 GAL.	550003640	ANODE KIT MAGNESIUM (INCLUDES ANODE, GASKET & BUSHING)	\$34
40-50 GAL.	550003505	ANODE KIT MAGNESIUM (INCLUDES ANODE, GASKET & BUSHING)	\$34
80-105 GAL.	550003527	ANODE KIT MAGNESIUM (INCLUDES ANODE, GASKET & BUSHING)	\$66
30 GAL.	550003693	ANODE KIT ALUMINUM (INCLUDES ANODE, GASKET & BUSHING)	\$33
40-50 GAL.	550003694	ANODE KIT ALUMINUM (INCLUDES ANODE, GASKET & BUSHING)	\$34
80-105 GAL.	550003695	ANODE KIT ALUMINUM (INCLUDES ANODE, GASKET & BUSHING)	\$66
30-50 GAL.	240012250	FLANGE CAP	\$36
80-105 GAL.	240012251	FLANGE CAP	\$13
30-50 GAL.	240012210	FLANGE GASKET	\$2
80-105 GAL.	240012238	FLANGE GASKET	\$4
40-50 GAL.	550003510	HARDWARE KIT (INCLUDES BOLTS & NUTS FOR FLANGE CAP)	\$4
80-105 GAL.	550003525	HARDWARE KIT (INCLUDES BOLTS & NUTS FOR FLANGE CAP)	\$4
H2O 30 GL	240012474	OUTSIDE TANK COVER	\$96
H2O 40 GL	240012329	OUTSIDE TANK COVER	\$97
H2O 50 GL	240012330	OUTSIDE TANK COVER	\$104
H2O 80 GL	240012331	OUTSIDE TANK COVER	\$113
H2O 105 GL	240012332	OUTSIDE TANK COVER	\$127
30-50 GAL.	240012483	TEMPERATURE GAUGE	\$14
80-105 GAL.	240012484	TEMPERATURE GAUGE	\$21



**TERMS & CONDITIONS OF SALE - GENERAL TERMS**

**PRICES & SPECIFICATIONS:** All pricing and specifications subject to change without notice. The prices herein supersede all prior quotations.

**ORDERS:** Orders will be accepted based on prices in effect at the time the order is received. No order or contract will become an obligation on our part until accepted by the General Sales Department. ECR International shall not be liable for any delay or failure in the delivery or shipment of goods due to any cause or causes beyond its control.

**TAXES:** Add to the prices and terms quoted any manufacturers' or sales tax payable on the transaction under any effective statute.

**SHIPMENTS**

**TRUCKLOADS:** \$40,000 Net Order Value - Freight Prepaid. Indirect Water Heaters and Commercial Boiler lines can be added to any residential order for freight purposes. Authorized Distributors can combine Argo, Airco, Dunkirk, EMI, Olsen, Pennco, Utica Boilers and Utica Heating on one purchase order to earn free freight.

Stop off charges of \$150 will apply to stop off locations within 100 miles of final destination. Please call for pricing for stop off special handling for a location further than 100 miles or for special handling pricing for services such as lift gate, unloading assistance, etc.

**LESS THAN TRUCKLOAD SHIPMENT: F.O.B. ECR INTERNATIONAL - FACTORY OR WAREHOUSE**

**SALES ORDER INFORMATION CHECK LIST**

The following information must be included on equipment or parts orders to insure proper shipment & invoicing:

- |  |  |
|--|--|
| 1) Purchase Order Number                       | 7) Pricing   |
| 2) Bill to Address                             | 8) Product Description (Model, Size, etc.)   |
| 3) Ship to Address                             | 9) Fuel Type (Oil, Natural Gas, Propane)   |
| 4) Method of Shipment (trailer load, UPS)      | 10) Electrical (Operating Voltage, Cycles, Phases, etc.)   |
| 5) Requested Ship Date                         | 11) Non-Standard Equipment (Indicate "Optional" when substituted for standard equipment at extra cost listed. Indicate added to standard equipment.) |
| 6) Special Instructions ("Carrier to call...") | 12) Kits or Parts (Orders for kits or parts must indicate equipment size and series.)  |

Send orders to:

**E-mail: [ecrorderentry@ecrinternational.com](mailto:ecrorderentry@ecrinternational.com)**

**Fax: (315) 724-9319**

Please note the following Remit to Address:

**ECR International, Inc.  
P.O. Box 8000 Department 039  
Buffalo, NY 14267**

## U.S. DISTRIBUTOR - RETURN MATERIAL POLICY

**Prior Approval Required** - All returns for exchange, credit, repair service or warranty claim must be approved by ECR International and require an RMA number prior to return of the material. A request must be completed via the online web portal. Please log on to [www.ecrcustomerportal.com](http://www.ecrcustomerportal.com) to complete your request for return. If you do not already have access to the customer web portal, please contact ECR International Customer Service at 1-800-325-5479 to be set-up.

**Eligibility** – An RMA Request must be received within 60 days from the date of invoice for returns of New & Unused product in original packaging. A restocking fee of 15% will be charged for all new and unused returns that are approved for return. Special Order Products (items not offered as standard in ECR International trade price book) are not eligible for return as new and unused product. Request for Warranty Returns must be made within the period covered by the warranty and must fall under the terms and conditions specified in the warranty.

**Repair Service** - Request for repair or rework of product damaged by customer is classified as Repair Service. Repair Service is billed at \$75.00 per hour for labor and net price for parts used in repair/rework. ECR International's Return Material (RM) department will evaluate the items returned for repair service. The customer will receive an estimate for the dollar amount, determined by ECR International's RM department, required to complete the repairs requested. A Purchase Order (PO) from the customer for that amount will be required before any work is performed.

**RMA Expiration Parts** - Once the RMA number is issued, the product must be returned within 60 days of the RMA date, or the RMA will be canceled. Products approved for return that are received after 60 days from the RMA date will not be accepted.

**Shipping & Packaging** - All returns must have a valid RMA number clearly displayed on the exterior of the package or the package will not be accepted. All returns of new and unused product must be in the original packaging. All returns must be shipped prepaid by the customer unless otherwise directed by ECR as indicated on the RMA Verification. Ship all approved return material to the facility indicated on the approved RMA Request by the date indicated.

**Replacement Product** - If replacement product is desired it must be indicated on the RMA Request. A PO# is required for the replacement shipment and must be indicated on the RMA Request. All replacement products will be invoiced at the time of shipment. ECR will pay the ground freight for all warranty replacements.

**Application of Credit** - Credit for returned product will be applied to the customer's account (less restocking fees for New and Unused returns) only after confirmation of receipt by ECR and inspection of the product. Issuance of a credit for a partial return of product does not relieve the customer from the obligation to remit payment for the merchandise not returned in accordance with the payment terms referenced on the customer's invoice(s). Customer will have the option to have any product that is denied for credit returned at their expense.

**Returning Installed Finished Goods** (Complete boilers, furnaces, A/C units etc.)

- Equipment that is already installed should be repaired not replaced. Exceptions: leaking cast iron boilers in their first year or leaking water tanks. Leaking drain valves on water tanks are replaceable, make sure the leak is not on the valve. Tanks returned with the only leak being on the valve will be denied.
- Cast iron blocks (not complete boilers) older than one year and Indirect tanks that are leaking do not require prior approval. Simply type "Leaking" into the Authorization field and it will be accepted. Complete Cast iron boilers within their first year will still require prior authorization for full boiler replacement.
- Water leaks on copper and condensing boilers are repairable and will require prior authorization for any reason for removal.
- To guarantee credit, if a situation arises where equipment does need to be replaced, **prior authorization** from ECR is required. This will ensure that ECR has visibility to the problem and has had an opportunity to correct it prior to removal. *All equipment considered for removal should first be brought to the attention of Technical Support at 1-800-253-7900.*
- If approved, an authorization number will be given that will need to be entered in the RMA on the Customer Portal.
- For equipment that is removed from service without prior authorization by ECR, contact Customer Service. They will evaluate the circumstance and can issue a conditional RMA. The equipment will be tested in our lab to determine if removal was warranted and if credit will be given.

**RMA Expiration Equipment** - Once the RMA number is issued, the product must be returned within 30 days of the RMA date, or the RMA will be canceled. Products approved for return that are received after 30 days from the RMA date will not be accepted.



2201 Dwyer Avenue, Utica, NY 13501  
Tel. 800 325 5479  
[www.ecrinternational.com](http://www.ecrinternational.com)

All specifications subject to change without notice.  
©2021 ECR International, Inc.  
PN 240011133 REV. J [01/01/2021]