



US Trade Price Book - 2023

Effective 2/15/23



There are some things you can always depend on...



www.cticaboilers.com



Manufactured by:
ECR International Inc.
2201 Dwyer Avenue, Utica, NY 13501
Tel. 800 325 5479
www.ecrinternational.com
PN 240005093 REV. V [08/15/2023]

CUSTOMER SUPPORT TEAM

CUSTOMER SERVICE:

Phone: (800) 325-5479 option #2
Fax: (315) 724-9319
Email Purchase Orders: ecrorderentry@ecrinternational.com
Email Inquiries: customerservice@ecrinternational.com

TECHNICAL SUPPORT:

Phone: (800) 253-7900
Fax: (866) 432-7329
Email: technical.support@ecrinternational.com

MARKETING SUPPORT:

Phone: (800) 325-5479
Fax: (315) 733-1759
E-mail: marketing@ecrinternational.com

WWW.ECRCUSTOMERPORTAL.COM

Your On-line Access to:

- Order Status
- Invoices
- Statements
- RMA
- Serial Number Look-Up
- Literature

Table of Contents

<u>Condensing Natural / LP Boilers with [AI] Control (Gas Adaptive)</u>		<u>4-7</u>
MAC/MAH	Stainless Steel Wall Hung Combi & Heating Boilers (75-205 MBH)	4
MACF/MAHF	Stainless Steel Floor Standing Combi & Heating Boilers (75-205 MBH)	6
<u>Condensing Natural / LP Boilers</u>		<u>8-11</u>
UCS 240	Stainless Steel Wall Hung Heating Boilers (241 MBH)	8
UCS 380	Stainless Steel Floor Standing Heating Boilers (379 MBH)	10
<u>Controls & Venting</u>		<u>12-15</u>
MBC	Multiple Boiler Control (MBC) On/Off	12
VENTING	Coaxial, Twin Pipe & CPVC Venting for Condensing Boilers	13
<u>Electric Boilers</u>		<u>16-17</u>
AT SERIES	Electric Wall Hung Heating Boilers	16
<u>Natural / LP Boilers</u>		<u>18-29</u>
SVB	Cast-Iron Induced Draft Chimney/Sidewall Vented Boilers (42.5-187.5 MBH)	18
MGB-K	Cast-Iron Chimney Vented Boilers (59-235 MBH)	20
MGC	Cast-Iron Chimney Vented Boilers (262-299 MBH)	22
PEG-E	Cast-Iron Steam Boilers (75-299 MBH)	24
JE COMMERCIAL	Cast-Iron Commercial Steam Boilers (300-1,500 MBH)	26
<u>Oil Boilers</u>		<u>30-39</u>
TRIFIRE TRB	Cast-Iron 3-Pass Boilers (105-252 MBH)	30
DHW MODULE	Domestic Hot Water Module	30
STARFIRE SFH	Cast-Iron Chimney Vented Boilers (119-259 MBH)	34
SBO	Cast-Iron Steam Boilers (119-210 MBH)	38
<u>Indirect Tanks</u>		<u>40-49</u>
H2O GL	Single Coil Glass Lined Indirect Water Heaters (31-106 GALS)	40
H2O SC	Single Coil Stainless Steel Indirect Water Heaters (30-115 GALS)	42
H2O DC	Single & Dual Coil Stainless Steel Solar Water Heaters (60-115 GALS)	44
H2O BT	Stainless Steel Buffer Tanks with and without Coil (22-115 GALS)	46
H2O ST	Stainless Steel Storage Tanks (30-115 GALS)	48
<u>Terms, Shipping & Delivery Policy, RMA Policy</u>		<u>50-52</u>

MAC/MAH Stainless Steel Wall Hung Combi & Heating Boilers

- MBH Input 75 - 164 (CH) / 115.5 - 205 (DHW)
- Up to 95% AFUE
ENERGY STAR® Certified
- [AI] Control Technology Recognizes Natural or LP Gas
No field conversion kit required.
- 6.9:1 Turndown Modulation Ratio in DHW Mode(115)
7:1 Turndown Modulation Ratio in DHW Mode (150/205)
4.5:1 Turndown Modulation Ratio in CH Mode (75)
5.6:1 Turndown Modulation Ratio in CH Mode (100/115)
5.7:1 Turndown Modulation Ratio in CH Mode (125/150)
5.5:1 Turndown Modulation Ratio in CH Mode (165/205)
- 2.5 gpm DHW @ 70°F Rise (115)
3.5 gpm DHW @ 70°F Rise (150)
5 gpm DHW @ 70°F Rise (205)
- LABOR SAVER™ Primary/Secondary Manifold Included
- Low Water Pressure Switch
- Wall Hung or Floor Stand Kit Available



General Information (See IOM for Complete Instructions)								
Model	MAH-75	MAH-100	MAH-125	MAC-115	MAC-150	MAH-165	MAC-205	
System Supply/Return	G 3/4" Straight Thread					G 1" Straight Thread		
System Supply/Return with Provided Manifold	1 1/4" Copper Sweat					1 1/2" Copper Sweat	1 1/4" Copper Sweat	
Gas Inlet	3/4" NPT					3/4" NPT		
Condensate Drain	13/16" ID Hose					3/4" NPT		
DHW Outlet (125 Optional)	G 1/2" Straight Thread					G 3/4" Straight Thread		
DHW (Cold Water) Inlet	1/2"					3/4"		
Electrical	120 Volts AC, 60 hertz, 1 phase, less than 12 amps (15 amp circuit recommended)							
Water Content (Gallons)	1					1 1/4		
Dimensions	A-Height	30"					30"	
	B-Width	17 3/4"					17 3/4"	
	C-Depth	13 9/16"					21 1/2"	

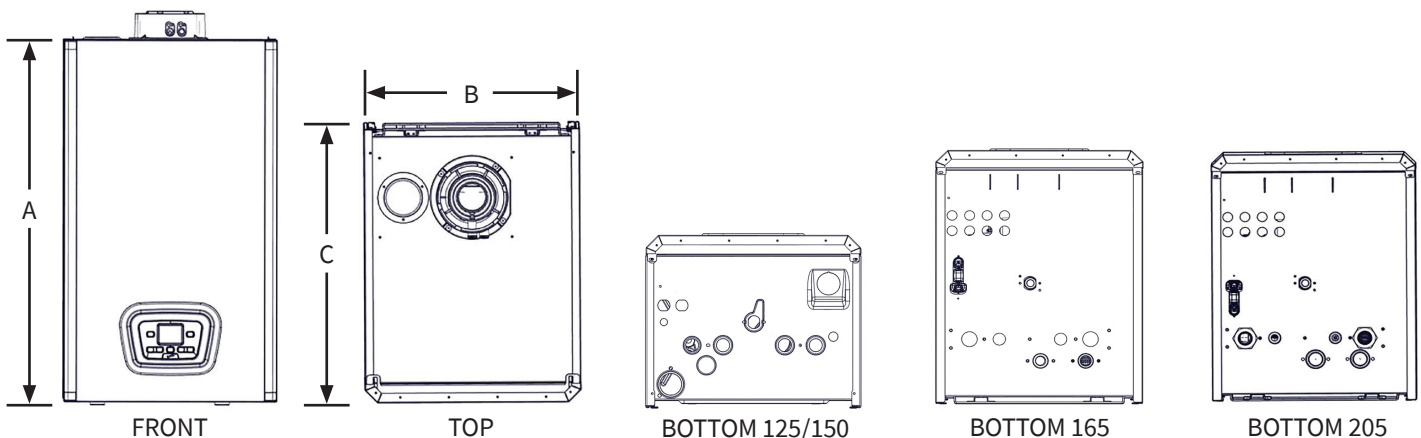

MAC/MAH - Stainless Steel Wall Hung Combi & Heating Boilers										
Model	Item Number	Type	Input MBH CH	Input MBH DHW	AHRI Net MBH	AFUE	Fuel	Pump	Shp. Wgt. lbs	Trade Price
MAH75	MAH107503600110	HEATING	75	N/A	60	92.0%	NAT/LP	LESS	94	\$2,726
MAH100	MAH110003600110	HEATING	93.5	N/A	74	95.0%	NAT/LP	LESS	94	\$3,193
MAH125	MAH112503600110	HEATING	125	N/A	98	95.0%	NAT/LP	LESS	148	\$3,900
MAH165	MAH116503600110	HEATING	164	N/A	133	95.0%	NAT/LP	LESS	158	\$4,580
MAC115	MAC111503600110	COMBI	93.5	115.5	74	95.0%	NAT/LP	LESS	100	\$3,402
MAC150	MAC115003600110	COMBI	125	153	98	95.0%	NAT/LP	LESS	100	\$4,164
MAC205	MAC120503600110	COMBI	164	205	133	95.0%	NAT/LP	LESS	178	\$4,836
MAH75	MAH107503640110	HEATING	75	N/A	60	92.0%	NAT/LP	TACO ECM	103	\$2,917
MAH100	MAH110003640110	HEATING	93.5	N/A	74	95.0%	NAT/LP	TACO ECM	103	\$3,400
MAH125	MAH112503640110	HEATING	125	N/A	98	95.0%	NAT/LP	TACO ECM	148	\$4,098
MAH165	MAH116503640110	HEATING	164	N/A	133	95.0%	NAT/LP	TACO ECM	168	\$4,776
MAC115	MAC111503640110	COMBI	93.5	115.5	74	95.0%	NAT/LP	TACO ECM	100	\$3,607
MAC150	MAC115003640110	COMBI	125	153	98	95.0%	NAT/LP	TACO ECM	100	\$4,365
MAC205	MAC120503640110	COMBI	164	205	133	95.0%	NAT/LP	TACO ECM	178	\$5,031
MAH75	MAH107503620110	HEATING	75	N/A	60	92.0%	NAT/LP	GRUNDFOS	103	\$2,917
MAH100	MAH110003620110	HEATING	93.5	N/A	74	95.0%	NAT/LP	GRUNDFOS	103	\$3,400
MAH125	MAH112503620110	HEATING	125	N/A	98	95.0%	NAT/LP	GRUNDFOS	148	\$4,098
MAH165	MAH116503620110	HEATING	164	N/A	133	95.0%	NAT/LP	GRUNDFOS	168	\$4,776
MAC115	MAC111503620110	COMBI	93.5	115.5	74	95.0%	NAT/LP	GRUNDFOS	100	\$3,607
MAC150	MAC115003620110	COMBI	125	153	98	95.0%	NAT/LP	GRUNDFOS	100	\$4,365
MAC205	MAC120503620110	COMBI	164	205	133	95.0%	NAT/LP	GRUNDFOS	178	\$5,031

MAC/MAH (Use Parts Multiplier for All of the Following)			
Model	Item Number	Description	Trade Price
MAC(H)	BD710487302V	OUTSIDE AIR SENSOR	\$47
MAC(H)	550003189	DHW SENSOR KIT	\$102
MAC(H)	240010266	FLOOR STAND KIT	\$852
MAC(H)	550003212	HEAT EXCHANGER CLEANING KIT	\$71

MAC/MAH Venting Adapters (Use Parts Multiplier for All of the Following)			
Model	Item Number	Description	Trade Price
MAC(H)	KHG714059113	TO CONVERT FROM CONCENTRIC TO 3" TWIN PIPE POLYPROPYLENE	\$22
MAC(H)	550003184	TWIN PIPE ADAPTER 60MM TO CPVC 3"	\$74
MAC(H)	KHG714089010	TO CONVERT FROM CONCENTRIC TO 3" TWIN PIPE POLYPROPYLENE	\$50
MAC(H)	550003403	TWIN PIPE ADAPTER 80MM TO CPVC 3"	\$138

NOTE: For 2" venting, a 3" x 2" reducer must be field supplied.

MACF/MAHF Stainless Steel Floor Standing Combi & Heating Boilers

- MBH Input 75 - 164 (CH) / 115.5 - 205 (DHW)
- Up to 95% AFUE
ENERGY STAR® Certified
- [AI] Control Technology Recognizes Natural or LP Gas
No field conversion kit required.
- 6.9:1 Turndown Modulation Ratio in DHW Mode (115)
7:1 Turndown Modulation Ratio in DHW Mode (150/205)
5.6:1 Turndown Modulation Ratio in CH Mode (100/115)
5.7:1 Turndown Modulation Ratio in CH Mode (125/150)
5.5:1 Turndown Modulation Ratio in CH Mode (165/205)
- 2.5 gpm DHW @ 70°F Rise (115)
3.5 gpm DHW @ 70°F Rise (150)
5.0 gpm DHW @ 70°F Rise (205)
- LABOR SAVER™ Primary/Secondary Manifold Built-In
- Low Water Pressure Switch
- Compact, Floor Standing Design



General Information (See IOM for Complete Instructions)				
Model	MAHF-75/100/125	MACF-115/150	MAHF-165	MACF-205
Water Return/Supply	1 1/4" Copper	1 1/4" Copper	1 1/2" Copper	1 1/2" Copper
Gas	3/4" NPT	3/4" NPT	3/4" NPT	3/4" NPT
Condensate Drain	3/4" NPT	3/4" NPT	3/4" NPT	3/4" NPT
DHW Outlet (125 Optional)	3/4" SWT	1/2" SWT	NA	3/4" SWT
DHW (Cold Water) Inlet	NA	1/2" SWT	NA	3/4" SWT
Electrical	120 Volts AC, 60 hertz, 1 phase, less than 12 amps (15 amp circuit recommended)			
Water Content (Gallons)	1	1	1.25	1.25
Dimensions	A-Height	43.65"	43.65"	43.65"
	B-Width	24.7"	24.7"	24.7"
	C-Depth	17.46"	17.46"	23.55"

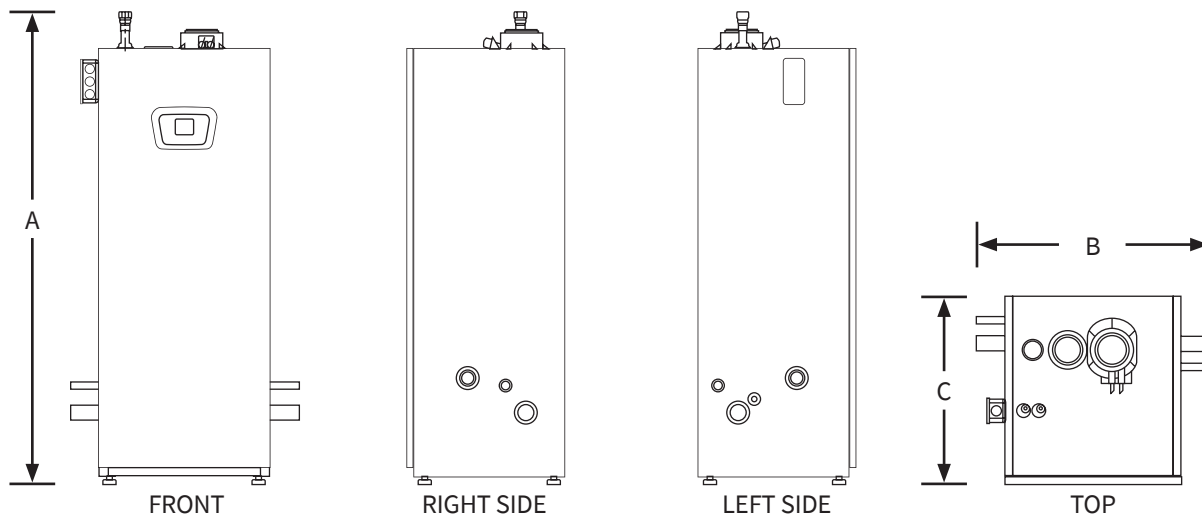

MACF/MAHF - Stainless Steel Floor Standing Combi & Heating Boilers

Model	Item Number	Type	Input MBH CH	Input MBH DHW	AHRI Net MBH	AFUE	Fuel	Pump	Shp. Wgt. lbs	Trade Price
MAHF75	MAH107505600110	HEATING	75	N/A	60	92.0%	NAT/LP	LESS	117	\$3,077
MAHF100	MAH110005600110	HEATING	93.5	N/A	74	95.0%	NAT/LP	LESS	117	\$3,575
MAHF125	MAH112505600110	HEATING	125	N/A	98	95.0%	NAT/LP	LESS	148	\$4,350
MAHF165	MAH116505600110	HEATING	164	N/A	133	95.0%	NAT/LP	LESS	158	\$5,266
MACF115	MAC111505600110	COMBI	93.5	115.5	74	95.0%	NAT/LP	LESS	148	\$3,866
MACF150	MAC115005600110	COMBI	125	153	98	95.0%	NAT/LP	LESS	148	\$4,645
MACF205	MAC120505600110	COMBI	164	205	133	95.0%	NAT/LP	LESS	168	\$5,561
MAHF75	MAH107505640110	HEATING	75	N/A	60	92.0%	NAT/LP	TACO ECM	126	\$3,268
MAHF100	MAH110005640110	HEATING	93.5	N/A	74	95.0%	NAT/LP	TACO ECM	126	\$3,774
MAHF125	MAH112505640110	HEATING	125	N/A	98	95.0%	NAT/LP	TACO ECM	148	\$4,552
MAHF165	MAH116505640110	HEATING	164	N/A	133	95.0%	NAT/LP	TACO ECM	158	\$5,490
MACF115	MAC111505640110	COMBI	93.5	115.5	74	95.0%	NAT/LP	TACO ECM	148	\$4,066
MACF150	MAC115005640110	COMBI	125	153	98	95.0%	NAT/LP	TACO ECM	148	\$4,848
MACF205	MAC120505640110	COMBI	164	205	133	95.0%	NAT/LP	TACO ECM	168	\$5,786
MAHF75	MAH107505620110	HEATING	75	N/A	60	92.0%	NAT/LP	GRUNDFOS	126	\$3,268
MAHF100	MAH110005620110	HEATING	93.5	N/A	74	95.0%	NAT/LP	GRUNDFOS	126	\$3,774
MAHF125	MAH112505620110	HEATING	125	N/A	98	95.0%	NAT/LP	GRUNDFOS	148	\$4,552
MAHF165	MAH116505620110	HEATING	164	N/A	133	95.0%	NAT/LP	GRUNDFOS	158	\$5,490
MACF115	MAC111505620110	COMBI	93.5	115.5	74	95.0%	NAT/LP	GRUNDFOS	148	\$4,066
MACF150	MAC115005620110	COMBI	125	153	98	95.0%	NAT/LP	GRUNDFOS	148	\$4,848
MACF205	MAC120505620110	COMBI	164	205	133	95.0%	NAT/LP	GRUNDFOS	168	\$5,786

MACF/MAHF (Use Parts Multiplier for All of the Following)

Model	Item Number	Description	Trade Price
MAC(H)F	BD710487302V	OUTSIDE AIR SENSOR	\$47
MAC(H)F	550003189	DHW SENSOR KIT	\$102
MAC(H)F	550003212	HEAT EXCHANGER CLEANING KIT	\$71

MACF/MAHF Venting Adapters (Use Parts Multiplier for All of the Following)

MAC(H)F	KHG714059113	TO CONVERT FROM CONCENTRIC TO 3" TWIN PIPE POLYPROPYLENE	\$22
MAC(H)F	550003184	TWIN PIPE ADAPTER 60MM TO CPVC 3"	\$74
MAC(H)F	KHG714089010	TO CONVERT FROM CONCENTRIC TO 3" TWIN PIPE POLYPROPYLENE	\$50
MAC(H)F	550003403	TWIN PIPE ADAPTER 80MM TO CPVC 3"	\$138

NOTE: For 2" venting, a 3" x 2" reducer must be field supplied.

UCS 240 Stainless Steel Wall Hung Heating Boilers

- MBH Input 241 (CH)
- 95% AFUE
ENERGY STAR® Certified
- LABOR SAVER™ Manifold Included
- 6.7:1 Modulation Turndown Ratio
- Wall Hung or Floor Base Kit Available
- Anti-Wind Function: Control automatically adjusts the fan speed to prevent loss of flame and lockouts
- Flame Stabilization: Control allows the flame to stabilize before modulating, preventing flame drop outs and recycling
- Optional Plug-and-Play, CSD-1 Kit Available



General Information (See IOM for Complete Instructions)		
Model	UCS 240	
Water Return/Supply	1"	
Gas	3/4" NPT	
Condensate Drain	3/4" NPT	
Electrical	120 Volts AC, 60 hertz, 1 phase, less than 12 amps (15 amp circuit recommended)	
Water Content (Gallons)	.8	
Dimensions	A-Height	31 1/16"
	B-Width	17 3/4"
	C-Depth	23"

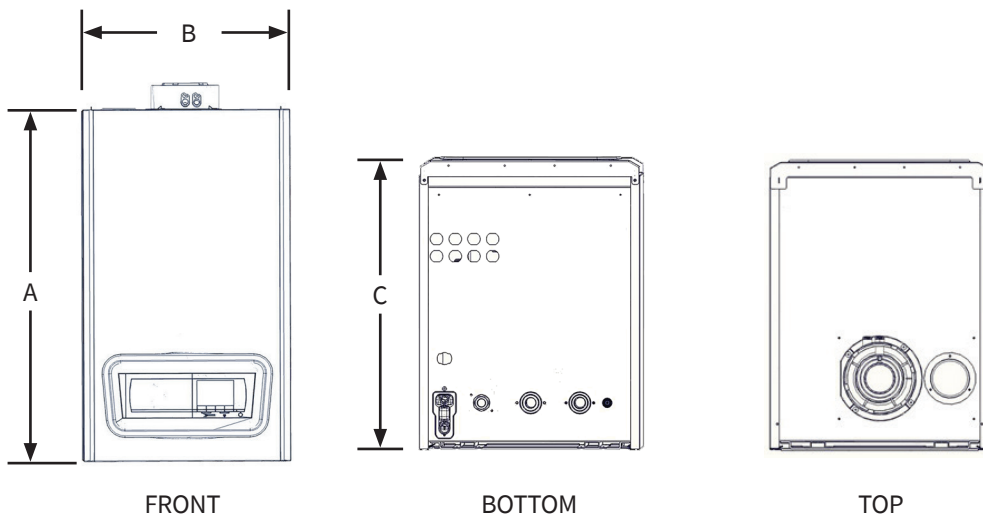

UCS 240 - Stainless Steel Wall Hung Heating Boilers

Model	Item Number	Input MBH	AHRI Net MBH	AFUE	Fuel	Pump	Shp. Wgt. lbs	Trade Price
UCS 240	UCS124000600110	241	216	95.0%	NAT	LESS	145	\$8,087

UCS 240 (Use Parts Multiplier for All of the Following)

Model	Item Number	Description	Trade Price
UCS 240	550003322	MANUAL RESET HIGH LIMIT KIT L4006E1109	\$334
UCS 240	550003323	MANUAL RESET LWCO KIT	\$321
UCS 240	550003332	CSD-1 KIT (INCLUDES HIGH LIMIT AND MANUAL RESET LWCO)	\$655
UCS 240	550003354	COMMON VENTING CHECK VALVE KIT	\$468
UCS 240	550003316	LP CONVERSION KIT	\$214
UCS 240	BD710487302V	OUTDOOR AIR SENSOR	\$47
UCS 240	550003189	DHW SENSOR KIT	\$102
UCS 240	550003304	FLOOR BASE KIT	\$662

UCS 240 Venting Adapters (Use Parts Multiplier for All of the Following)

UCS 240	KHG714089010	TO CONVERT FROM CONCENTRIC TO 3" TWIN PIPE POLYPROPYLENE	\$50
---------	--------------	--	------

UCS 380 Stainless Steel Floor Standing Heating Boilers

- MBH Input 379
- 95% Thermal Efficiency
- LABOR SAVER™ Manifold Included
- 10.5:1 Modulation Turndown Ratio
- Compact, Floor Standing Design
- Anti-Wind Function: Control automatically adjusts the fan speed to prevent loss of flame and lockouts
- Flame Stabilization: Control allows the flame to stabilize before modulating, preventing flame drop outs and recycling
- Optional Plug-and-Play, CSD-1 Kit Available



General Information (See IOM for Complete Instructions)		
Model	UCS 380	
Water Return/Supply	1 1/2"	
Gas	1" NPT	
Condensate Drain	3/4" NPT	
Electrical	120 Volts AC, 60 hertz, 1 phase, less than 12 amps (15 amp circuit recommended)	
Water Content (Gallons)	4.6	
Dimensions	A-Height	50"
	B-Width	23 5/8"
	C-Depth	25 1/2"

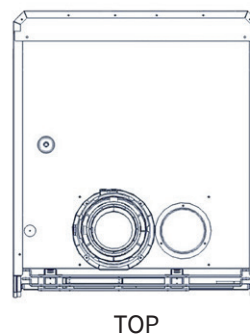
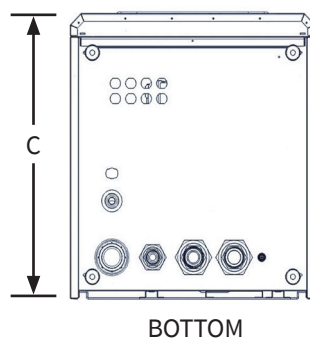
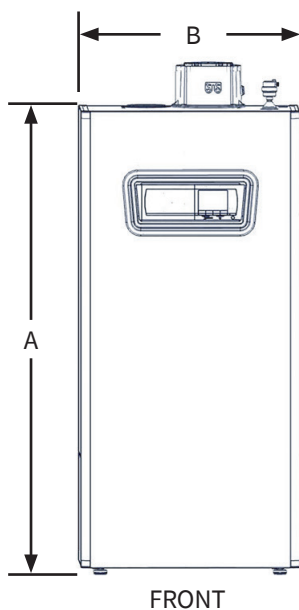

UCS 380 - Stainless Steel Floor Standing Heating Boilers								
Model	Item Number	Input MBH	AHRI Net MBH	Therm. Eff.	Fuel	Pump	Shp. Wgt. lbs	Trade Price
UCS 380	UCS138000600110	379	303	95.0%	NAT	LESS	255	\$12,718

UCS 380 (Use Parts Multiplier for All of the Following)			
Model	Item Number	Description	Trade Price
UCS 380	550003322	MANUAL RESET HIGH LIMIT KIT L4006E1109	\$334
UCS 380	550003323	MANUAL RESET LWCO KIT	\$321
UCS 380	550003332	CSD-1 KIT (INCLUDES HIGH LIMIT AND MANUAL RESET LWCO)	\$655
UCS 380	550003354	COMMON VENTING CHECK VALVE KIT	\$468
UCS 380	550003317	LP CONVERSION KIT	\$214
UCS 380	BD710487302V	OUTDOOR AIR SENSOR	\$47
UCS 380	550003189	DHW SENSOR KIT	\$102

UCS 380 Venting Adapters (Use Parts Multiplier for All of the Following)			
UCS 380	BD7106314V	TO CONVERT FROM CONCENTRIC TO 4" TWIN PIPE POLYPROPYLENE	\$164

NOTE: Twin pipe venting is polypropylene only. CPVC adapter not available.

















MBC Multiple Boiler Control

- Operation of up to Four Boilers
- LCD Display
- Push Buttons for Navigating Settings
- Warm Weather Shutdown (WWSD)
- Set Back Scheduling
- Boiler Stage Delay
- Boiler Rotation
- Combustion or Alarm Control Relay
- Flow or Combustion Air Proof Delay
- Energy Management System Compatible (0-10 or 2-10 Vdc)
- Sensors Included:
 - (1) Outdoor Sensor
 - (2) Water Temperature Sensors









MBC - Staging Control			
Model	Item Number	Description	Trade Price
AMB4B	AMB4BUB	MULTIPLE BOILER CONTROL (MBC)	\$1,658
Additional Accessories			
AMB4B	240012663	WATER TEMPERATURE SENSOR	\$125
AMB4B	240012664	OUTDOOR SENSOR	\$125



VENTING

Coaxial Venting (Use Parts Multiplier for All of the Following)							
75/100/115 125/150	165/205	UCS 240	UCS 380	Image	Item Number	Description	Trade Price
X					KUG714059511	2"x4" (60/100mm)COAXIAL PIPE 3.28' (1m) L	\$50
X					KUG714059611	2"x4" (60/100mm)HORIZONTAL VENT TERM	\$63
X					KUG714059711	2"x4" (60/100mm)COAXIAL 90 ELBOWS	\$40
X					KUG714059811	2"x4" (60/100mm)COAXIAL 45 ELBOWS	\$40
X					KUG714135813	2"x4" (60/100mm)VERTICAL VENT TERM	\$149
	X	X			KHG714088512	3"x5" (80/125mm)COAXIAL PIPE 3.28' (1m) L	\$74
	X	X			KHG714088713	3"x5" (80/125mm)COAXIAL 90 ELBOWS	\$41
	X	X			KHG714088812	3"x5"(80/125mm)COAXIAL 45 ELBOWS	\$41
	X	X			KHG714088911	3"x5" (80/125mm)HORIZONTAL VENT TERM	\$84
	X	X			KHG714093512	3"x5" (80/125mm)VERTICAL VENT TERM	\$117
			X		KUG714133311	4"x6" (110/160mm)HORIZONTAL VENT TERM	\$309
			X		KUG714133411	4"x6"(110/160mm)VERTICAL VENT TERM	\$392
			X		KUG714133511	4"x6" (110/160mm)COAXIAL 45 ELBOWS	\$110
			X		KUG714133611	4"x6" (110/160mm)COAXIAL 90 ELBOWS	\$110
			X		KUG714133811	4"x6" (110/160mm)COAXIAL PIPE 3.28' (1m) L	\$151

VENTING

Twin Pipe Polypropylene Venting (Use Parts Multiplier for All of the Following)								
75/100/115 125/150	165/205	UCS 240	UCS 380	Image	Item Number	Description	Trade Price	
X					KHG714059113	TO CONVERT FROM CONCENTRIC TO 3" TWIN PIPE POLYPROPYLENE	\$22	
X	X	X			550003416	3" (80mm)VENTING CLAMP SINGLE WALL	\$47	
X	X	X			550003452	3" (80mm)CLAMSHELL CLAMP (5PK)	\$46	
X	X	X			KUG714132010	3" (80mm)HORIZONTAL VENT TERM	\$25	
X	X	X			KUG714132110	3" (80mm)VERTICAL VENT TERM	\$62	
X	X	X			550003734	3" (80mm)POLYPROPYLENE 45 ELBOWS W/ CLAMP	\$19	
X	X	X			550003735	3" (80mm)POLYPROPYLENE 90 ELBOWS W/ CLAMP	\$19	
X	X	X			550003767	3" (80mm)POLYPROPYLENE PIPE 3.28' (1m) L W/ CLAMP	\$27	
	X	X			KHG714089010	TO CONVERT FROM CONCENTRIC TO 3" TWIN PIPE POLYPROPYLENE	\$50	
			X		550003453	4" (110mm)CLAMSHELL CLAMP (5PK)	\$62	
			X		BD7106314V	TO CONVERT FROM CONCENTRIC TO 4" TWIN PIPE POLYPROPYLENE	\$164	
			X		KUG714132710	4" (110mm)HORIZONTAL VENT TERM	\$159	
			X		KUG714132810	4" (110mm)VERTICAL VENT TERM	\$142	
			X		550003731	4" (110mm)POLYPROPYLENE 45 ELBOWS W/ CLAMP	\$42	
			X		550003732	4" (110mm)POLYPROPYLENE 90 ELBOWS W/ CLAMP	\$42	
			X		550003733	4" (110mm)POLYPROPYLENE PIPE 3.28' (1m) L W/ CLAMP	\$57	

VENTING

Twin Pipe CPVC Venting (Use Parts Multiplier for All of the Following)									
75/100/115 125/150	165/205	UCS 240	UCS 380	Image	Item Number	Description	Trade Price		
X					550003184	TWIN PIPE ADAPTER 60MM TO CPVC 3"	\$74		
	X	X			550003403	TWIN PIPE ADAPTER 80MM TO CPVC 3"	\$138		

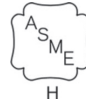

AT SERIES Electric Wall Hung Boilers

- 100% Efficient
- Compact Light Weight Wall Hung Design (70 lbs)
- Zero Emissions, Green Alternative (No Fossil Fuel, No Chimney, No Carbon Monoxide)
- Proven one piece cast iron heat exchanger
- Available in 2 or 4 element and modular boiler configurations:
 - 2 Element (4 capacities from 6 kW to 12 kW)
 - 4 Element (4 capacities from 12 kW to 24 kW)
 - Modular Boiler Configurations (40 kW+ for light commercial applications utilizing multiple boilers)
- 20 Year Limited Warranty (Residential)

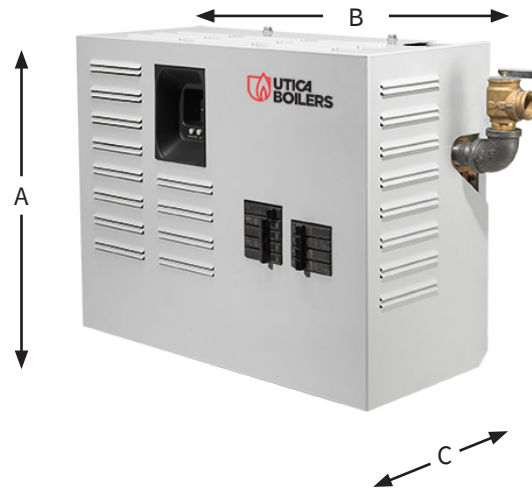

General Information (See IOM for Complete Instructions)		
Model		AT Series
Water Return/Supply		1 1/4" NPT
Dimensions	A-Height	16 15/32"
	B-Width	18 5/8"
	C-Depth	9 1/32"

AT Series Electric Boilers with Breakers							
Model	Item Number	Type	Size KW	Elem. No. & Size	bth/hr	Weight (lbs)	Trade Price
AT0623	AT062310C10	2-ELEMENT	6	2-3KW	20500	62	\$2,186
AT0824	AT082410C10	2-ELEMENT	8	2-4KW	27300	62	\$2,350
AT1025	AT102510C10	2-ELEMENT	10	2-5KW	34100	62	\$2,528
AT1226	AT122610C10	2-ELEMENT	12	2-6KW	41000	62	\$2,605
AT1243	AT124310C10	4-ELEMENT	12	4-3KW	41000	70	\$2,960
AT1644	AT164410C10	4-ELEMENT	16	4-4KW	54600	70	\$3,043
AT2045	AT204510C10	4-ELEMENT	20	4-5KW	68200	70	\$3,117
AT2446	AT244610C10	4-ELEMENT	24	4-6KW	82000	70	\$3,495
AT2800^	AT124310C10	MODULAR	28	4-3KW	95600	140	\$2,960
	AT164410C10			4-4KW			\$3,043
AT3200^	AT164410C10	MODULAR	32	4-4KW	109200	140	\$3,043
	AT164410C10			4-4KW			\$3,043
AT4000^	AT204510C10	MODULAR	40	4-5KW	136400	140	\$3,117
	AT204510C10			4-5KW			\$3,117

^When ordering modular boilers, order both part numbers listed. You will receive 2 boilers allowing for serial number tracking. Ratings are based on 240 operating voltage. Refer to IOM for reduced ratings based on 208 operating voltage.

AT Series Electric Boiler Service Parts (Use Parts Multiplier for the Following)			
Model	Item Number	Description	Trade Price
AT	1260006	Temperature/Pressure Gauge	\$34
AT	B27	Circuit Breaker 40 A - 2 Pole - G.E. THQP 240	\$82
AT	B28	Circuit Breaker 15 A - 1 Pole - G.E. THQP 115	\$54
AT	550003228	Pressure Vessel - Cast Iron, 4 Element	\$541
AT	550003227	Pressure Vessel - Cast Iron, 2 Element	\$375
AT	E13	Heating Element - 3KW/240 Volt	\$90
AT	E14	Heating Element - 4KW/240 Volt	\$112
AT	E15	Heating Element - 5KW/240 Volt	\$117
AT	E16	Heating Element - 6KW/240 Volt	\$123
AT	G12	Gasket - Heating Element	\$7
AT	VR-001.01	Relief Valve - 30 PSI	\$34
AT	B194	Neutral Terminal Block	\$106
AT	I25	Load Center Assembly - G.E. TLM812U2	\$177
AT	L9	Ground Connection Lug	\$17
AT	S47	Safety Limit Control (High Limit - Fixed Temp)	\$32
AT	240004756	Brass Well	\$32
AT	E1	Elbow 3/4" x 90°	\$4
	119000002	Transformer 115/24V, 40 VA	\$46
AT	240010289	Water Temperature Sensor Kit	\$79
AT	240010295	Control Board - 2 Element, kit, includes wires	\$711
AT	240010296	Control Board - 4 Element, kit, includes wires	\$769
AT	109010455	Cabinet	\$159

SVB Cast Iron Induced Draft Chimney/Side Wall Vented Boilers

- MBH Input 42.5 - 187.5 (CH)
- Up to 84.4% AFUE
- Dependable Cast Iron Heat Exchanger with Cast Iron Push Nipples
- Honeywell High Limit/Electronic Ignition Control
 - Recessed under the boiler's protective jacket
 - Digital Temperature display and diagnostics
 - Plug in connection for the inducer fan
 - Plug in connection for the system pump
- Induced Draft Fan



General Information (See IOM for Complete Instructions)						
Model	SVB-2	SVB-3	SVB-4	SVB-5	SVB-6	
Water Return/Supply	1 1/4" NPT					
Gas	1/2" NPT					
Electrical	120 Volts AC, 60 hertz, 1 phase, less than 12 amps (15 amp circuit recommended)					
Water Content (Gallons)	1.75	3.00	4.25	5.50	6.75	
Dimensions	A-Height	29"	29"	29"	29"	
	B-Width	11"	14 1/4"	17 1/2"	20 3/4"	24"
	C-Depth	23 1/4"	23 1/4"	23 1/4"	23 1/4"	23 1/4"

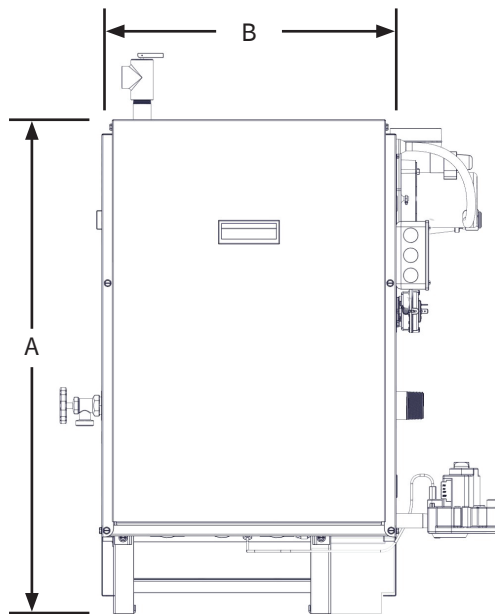

FRONT

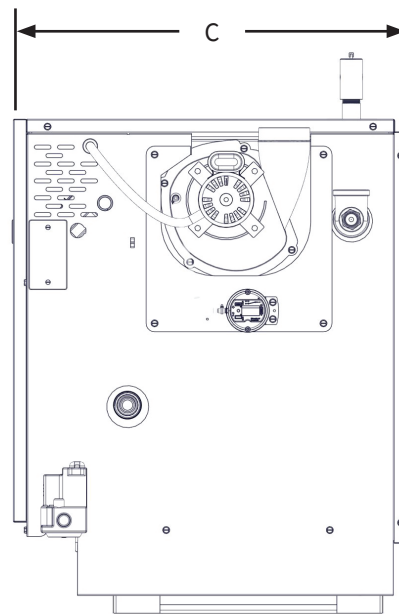

RIGHT SIDE

SVB - Cast Iron Induced Draft Chimney/Side Wall Vented Boilers

Model	Item Number	Input MBH	Htg. Cap. MBH	AHRI Net MBH	AFUE	Fuel	Pump	Shp. Wgt. Lbs	Trade Price
SVB-2	SVB204203100310	42.5	36	31	84.4%	NAT	LESS	225	\$3,222
SVB-3	SVB307503100310	75.0	63	55	84.0%	NAT	LESS	265	\$3,648
SVB-4	SVB411203100310	112.5	95	82	84.0%	NAT	LESS	322	\$4,028
SVB-5	SVB515003100310	150.0	127	109	84.0%	NAT	LESS	370	\$4,530
SVB-6	SVB618703100310	187.5	158	135	84.0%	NAT	LESS	431	\$5,326
SVB-2	SVB204203140310	42.5	36	31	84.4%	NAT	TACO ECM	225	\$3,337
SVB-3	SVB307503140310	75.0	63	55	84.0%	NAT	TACO ECM	265	\$3,759
SVB-4	SVB411203140310	112.5	95	82	84.0%	NAT	TACO ECM	322	\$4,141
SVB-5	SVB515003140310	150.0	127	109	84.0%	NAT	TACO ECM	370	\$4,640
SVB-6	SVB618703140310	187.5	158	135	84.0%	NAT	TACO ECM	431	\$5,437
SVB-2	SVB204203120310	42.5	36	31	84.4%	NAT	GRUNDFOS	225	\$3,337
SVB-3	SVB307503120310	75.0	63	55	84.0%	NAT	GRUNDFOS	265	\$3,759
SVB-4	SVB411203120310	112.5	95	82	84.0%	NAT	GRUNDFOS	322	\$4,141
SVB-5	SVB515003120310	150.0	127	109	84.0%	NAT	GRUNDFOS	370	\$4,640
SVB-6	SVB618703120310	187.5	158	135	84.0%	NAT	GRUNDFOS	431	\$5,437
SVB-2	SVB204203130310	42.5	36	31	84.4%	NAT	B&G	225	\$3,337
SVB-3	SVB307503130310	75.0	63	55	84.0%	NAT	B&G	265	\$3,759
SVB-4	SVB411203130310	112.5	95	82	84.0%	NAT	B&G	322	\$4,141
SVB-5	SVB515003130310	150.0	127	109	84.0%	NAT	B&G	370	\$4,640
SVB-6	SVB618703130310	187.5	158	135	84.0%	NAT	B&G	431	\$5,437

SVB - LP

Note: Boilers require a natural gas to LP conversion kit (field installed). Sold Separately. See below.

SVB - High Altitude

***Note: Boilers require a High Altitude conversion kit (field installed). Sold Separately. See Below. Item # is for 5000', consult factory for other elevations up to 10,000'.**

High Altitude - Capacity Reduces with Elevation. Refer to IOM for Actual Capacity Ratings.

SVB (Use Parts Multiplier for All of the Following)

Model	Item Number	Description	Trade Price
SVB	550002722	NATURAL GAS TO LP CONVERSION KIT (ALL SIZES)	\$120
SVB	43300660	LP TO NATURAL GAS CONVERSION KIT (ALL SIZES)	\$131
SVB-2	550004122	*NATURAL GAS HIGH ALTITUDE CONVERSION KIT - 5000' ELEVATION	\$120
SVB (3-5)	550004129	*NATURAL GAS HIGH ALTITUDE CONVERSION KIT - 5000' ELEVATION	\$120
SVB-6	550004136	*NATURAL GAS HIGH ALTITUDE CONVERSION KIT - 5000' ELEVATION	\$120
SVB-2	550004142	*LP GAS HIGH ALTITUDE CONVERSION KIT - 5000' ELEVATION	\$120
SVB (3-5)	550004145	*LP GAS HIGH ALTITUDE CONVERSION KIT - 5000' ELEVATION	\$120
SVB-6	550004149	*LP GAS HIGH ALTITUDE CONVERSION KIT - 5000' ELEVATION	\$120
SVB	14629014	4" THIMBLE (SIMPSON #915295)	\$57
SVB (2-5)	14629010	TJERNLUND VH-1-3" SIDE WALL VENT HOOD (SVB-2 TO SVB-5)	\$333
SVB (6)	14629011	TJERNLUND VH-1-4" SIDE WALL VENT HOOD (SVB-6)	\$395
SVB (2-5)	14624002	FILL-TROL #110 FOR WATER BOILERS 150 MBH OR LESS	\$421
SVB (6)	14624003	FILL-TROL #111 FOR WATER BOILERS OVER 150 MBH	\$585

MGB-K Cast Iron Chimney Vented Boilers

- MBH Input 59 - 235 (CH)
- 84% AFUE
- Dependable Cast Iron Heat Exchanger
- Hydrolevel FuelSmart Control
- Digital temperature display and diagnostics
- Built-In Low Water Cut-Off (LWCO)
- Control monitors water temperature and delays burner start until residual heat has been transferred to the system for maximum efficiency
- Low profile draft hood diverter



General Information (See IOM for Complete Instructions)							
Model	MGB-060K	MGB-095K	MGB-120K	MGB-150K	MGB-175K	MGB-205K	MGB-235K
Water Return/Supply	1 1/4" NPT						
Gas	1/2" NPT				3/4" NPT		
Electrical	120 Volts AC, 60 hertz, 1 phase, less than 12 amps (15 amp circuit recommended)						
Water Content (Gallons)	1.9	2.3	2.8	3.2	3.7	4.1	4.6
A-Height	32 1/8"	32 1/8"	32 1/8"	32 1/8"	32 1/8"	32 1/8"	32 1/8"
B-Width	13 3/8"	13 1/2"	16 1/4"	19"	21 7/8"	27 1/2"	27 1/2"
C-Depth	26"	26"	26"	26"	26"	26"	26"

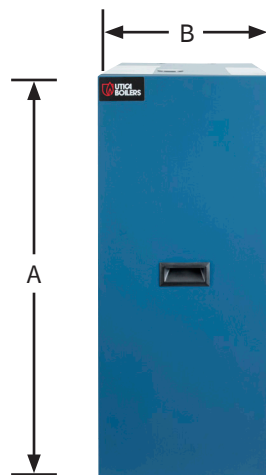

FRONT



LEFT SIDE

MGB-K - Cast Iron Chimney Vented Boilers

Model	Item Number	Input MBH	Htg. Cap. MBH	AHRI Net MBH	AFUE	Fuel	Pump	Shp. Wgt. lbs	Trade Price
MGB-060K	MGB306003200410	59	50	43	84.0%	NAT	LESS	215	\$3,289
MGB-095K	MGB409503200410	92.5	78	68	84.0%	NAT	LESS	250	\$3,532
MGB-120K	MGB512003200410	120	101	88	84.0%	NAT	LESS	295	\$3,773
MGB-150K	MGB615003200410	149	125	109	84.0%	NAT	LESS	335	\$4,102
MGB-175K	MGB717503200410	175	147	128	84.0%	NAT	LESS	385	\$4,757
MGB-205K	MGB820503200410	205	172	150	84.0%	NAT	LESS	420	\$5,097
MGB-235K	MGB923503200410	235	197	171	84.0%	NAT	LESS	465	\$5,751
MGB-060K	MGB306003240410	59	50	43	84.0%	NAT	TACO ECM	215	\$3,409
MGB-095K	MGB409503240410	92.5	78	68	84.0%	NAT	TACO ECM	250	\$3,652
MGB-120K	MGB512003240410	120	101	88	84.0%	NAT	TACO ECM	295	\$3,894
MGB-150K	MGB615003240410	149	125	109	84.0%	NAT	TACO ECM	335	\$4,222
MGB-175K	MGB717503240410	175	147	128	84.0%	NAT	TACO ECM	385	\$4,877
MGB-205K	MGB820503240410	205	172	150	84.0%	NAT	TACO ECM	420	\$5,215
MGB-235K	MGB923503240410	235	197	171	84.0%	NAT	TACO ECM	465	\$5,872
MGB-060K	MGB306003220410	59	50	43	84.0%	NAT	GRUNDFOS	215	\$3,409
MGB-095K	MGB409503220410	92.5	78	68	84.0%	NAT	GRUNDFOS	250	\$3,652
MGB-120K	MGB512003220410	120	101	88	84.0%	NAT	GRUNDFOS	295	\$3,894
MGB-150K	MGB615003220410	149	125	109	84.0%	NAT	GRUNDFOS	335	\$4,222
MGB-175K	MGB717503220410	175	147	128	84.0%	NAT	GRUNDFOS	385	\$4,877
MGB-205K	MGB820503220410	205	172	150	84.0%	NAT	GRUNDFOS	420	\$5,215
MGB-235K	MGB923503220410	235	197	171	84.0%	NAT	GRUNDFOS	465	\$5,872

MGB-K - LP

Note: Boilers require a natural gas to LP conversion kit (field installed). Sold Separately. See below.

MGB-K - High Altitude

***Note: Boilers require a High Altitude conversion kit (field installed). Sold Separately. See Below. Item # is for 5000', consult factory for other elevations up to 10,000'.**

High Altitude - Capacity Reduces with Elevation. Refer to IOM for Actual Capacity Ratings.

MGB-K (Use Parts Multiplier for All of the Following)

Model	Item Number	Description	Trade Price
MGB-K	550003778	CONVERSION KIT NAT. TO LP	\$97
MGB-K	550003884	CONVERSION KIT LP TO NAT.	\$107
MGB-K (3 Sec)	550003786	*NATURAL GAS HIGH ALTITUDE CONVERSION KIT - 5000' ELEVATION	\$67
MGB-K (4 Sec)	550003880	*NATURAL GAS HIGH ALTITUDE CONVERSION KIT - 5000' ELEVATION	\$67
MGB-K (5-9 Sec)	550003781	*NATURAL GAS HIGH ALTITUDE CONVERSION KIT - 5000' ELEVATION	\$84
MGB-K (3 Sec)	550003774	*LP GAS HIGH ALTITUDE CONVERSION KIT - 5000' ELEVATION	\$76
MGB-K (4 Sec)	550003776	*LP GAS HIGH ALTITUDE CONVERSION KIT - 5000' ELEVATION	\$67
MGB-K (5-9 Sec)	550003774	*LP GAS HIGH ALTITUDE CONVERSION KIT - 5000' ELEVATION	\$76
MGB-K	14624002	FILL-TROL #110 FOR WATER BOILERS 150 MBH OR LESS	\$421
MGB-K	14624003	FILL-TROL #111 FOR WATER BOILERS OVER 150 MBH	\$585

MGC - Cast Iron Chimney Vented Boilers

Model	Item Number	Input MBH	Htg. Cap. MBH	AHRI Net MBH	AFUE	Fuel	Pump	Shp. Wgt. lbs	Trade Price
MGC-8D	MGC826203200310	262	221	192	84.0%	NAT	LESS	552	\$5,910
MGC-9D	MGC929903200310	299	252	219	84.0%	NAT	LESS	616	\$6,798
MGC-8D	MGC826203240310	262	221	192	84.0%	NAT	TACO ECM	552	\$6,030
MGC-9D	MGC929903240310	299	252	219	84.0%	NAT	TACO ECM	616	\$6,918
MGC-8D	MGC826203220310	262	221	192	84.0%	NAT	GRUNDFOS	552	\$6,030
MGC-9D	MGC929903220310	299	252	219	84.0%	NAT	GRUNDFOS	616	\$6,918

MGC - LP

Note: Boilers require a natural gas to LP conversion kit (field installed). Sold Separately. See below.

MGC - High Altitude

***Note: Boilers require a High Altitude conversion kit (field installed). Sold Separately. See Below. Item # is for 5000', consult factory for other elevations up to 10,000'.**

High Altitude - Capacity Reduces with Elevation. Refer to IOM for Actual Capacity Ratings.

MGC (Use Parts Multiplier for All of the Following)

Model	Item Number	Description	Trade Price
MGC	550004168	CONVERSION KIT NAT. TO LP MGC-8/9	\$131
MGC-8D	43300636	CONVERSION KIT LP TO NAT. MGC-8	\$267
MGC-9D	43300637	CONVERSION KIT LP TO NAT. MGC-9	\$267
MGC	550004368	*NATURAL GAS HIGH ALTITUDE CONVERSION KIT - 5000' ELEVATION	\$80
MGC	550004373	*LP GAS HIGH ALTITUDE CONVERSION KIT - 5000' ELEVATION	\$80
MGC	14624002	FILL-TROL #110 FOR WATER BOILERS 150 MBH OR LESS	\$421
MGC	14624003	FILL-TROL #111 FOR WATER BOILERS OVER 150 MBH	\$585

**This page is intentionally left blank,
products continue on the following page.**

PEG-E Cast Iron Steam Boilers

- MBH Input 75 - 299 (CH)
- Up to 83.4% AFUE
- 7 Sizes Available
- Dependable Cast Iron Heat Exchanger
- Electronic ignition system
- Automatic Vent Damper
- LWCO (Probe Type) externally mounted for quick access
- Pressure High Limit Control with Pressure Gauge and Gauge Glass
- Stainless Steel Burners
- Easy Serviceability



General Information (See IOM for Complete Instructions)							
Model	PEG075EID	PEG112EID	PEG150EID	PEG187EID	PEG225EID	PEG262EID	PEG299EID
Return/ Supply Tappings	2" NPT						
Gas	1/2" NPT			3/4" NPT			
Electrical	120 Volts AC, 60 hertz, 1 phase, less than 12 amps (15 amp circuit recommended)						
A-Height	35 7/8"	35 7/8"	35 7/8"	35 7/8"	35 7/8"	35 7/8"	35 7/8"
B-Width	10 7/8"	14 1/8"	17 3/8"	20 5/8"	23 7/8"	27 1/8"	30 3/8"
C-Depth	28 3/8"	28 3/8"	29 3/8"	30 3/8"	30 3/8"	30 3/8"	30 3/8"

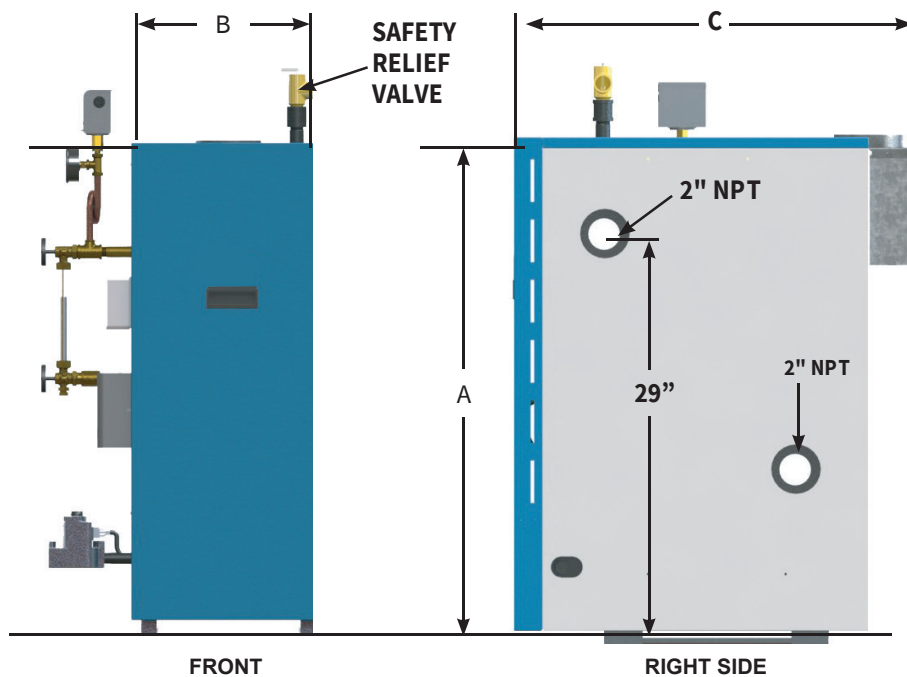

PEG E - Cast Iron Steam Boiler									
Model	Item Number	Input MBH	Htg. Cap. MBH	AHRI Net MBH	AHRI Net SQ. FT. Steam	AFUE	Fuel	Shp. Wgt. lbs	Trade Price
PEG075EID	PEG307503100510	75	62	47	195	82.2%	NAT	297	\$4,370
PEG112EID	PEG411203100510	112	93	70	292	82.4%	NAT	368	\$4,825
PEG150EID	PEG515003100510	150	125	94	391	82.6%	NAT	440	\$5,251
PEG187EID	PEG618703100510	187	156	117	488	82.8%	NAT	512	\$5,651
PEG225EID	PEG722503100510	225	188	141	587	83.0%	NAT	584	\$6,637
PEG262EID	PEG826203100510	262	219	164	685	83.2%	NAT	659	\$7,123
PEG299EID	PEG929903100510	299	250	188	782	83.4%	NAT	736	\$7,716

PEG E - LP

Note: Boilers require a natural gas to LP conversion kit (field installed). Sold Separately. See below.

PEG E - High Altitude

***Note: Boilers require a High Altitude conversion kit (field installed). Sold Separately. See Below. Item # is for 5000', consult factory for other elevations up to 10,000'.**

High Altitude - Capacity Reduces with Elevation. Refer to IOM for Actual Capacity Ratings.

PEG E (Use Parts Multiplier for All of the Following)

Model	Item Number	Description	Trade Price
PEG	550002702	CONVERSION KIT NAT. TO LP (3 - 5 SECTION)	\$80
PEG	550002703	CONVERSION KIT NAT. TO LP (6 - 9 SECTION)	\$84
PEG	550002704	CONVERSION KIT LP TO NAT. (3 - 5 SECTION)	\$88
PEG	550002705	CONVERSION KIT LP TO NAT. (6 - 9 SECTION)	\$116
PEG	550004368	*NATURAL GAS HIGH ALTITUDE CONVERSION KIT - 5000' ELEVATION	\$80
PEG	550004373	*LP GAS HIGH ALTITUDE CONVERSION KIT - 5000' ELEVATION	\$80
PEG	1630001	MCDONNELL & MILLER WF-2U-24 ELECTRONIC WATER FEEDER	\$674

JE COMMERCIAL Cast Iron Commercial Steam Boilers

JE Commercial Bases are pre-assembled at the factory with burner manifold, burner orifices, gas valves and electronic ignition installed; ready for field installation of the pre-tested sections and appropriate packages.

Electronic Ignition Base Standard Equipment:

- Base
- Fire Door
- Burner Orifice
- Manifold
- Main and Pilot Burner
- Electronic Pilot Gas Valve
- Intermittent Pilot Module
- Complete Jacket Assembly

Steam Trim Package:

- Low Water Cut-Off
- Glass Gauge Set
- Safety Valve
- Steam Gauge
- Pressure Limit
- Drain Valve



Plug 'N Play Harness and Junction Box

Individual base and junction box controls are designed for easy installation. The entire boiler links together in a snap with a color-coded factory supplied wiring harness

CSD-1 Options

Available with a CSD-1 option to comply with CSD-1 standards where required by building code. The CSD-1 option provides the increased number of controls and safety devices required to meet CSD-1 standards.

General Information (See IOM for Complete Instructions)			
	Right & Left End Tappings	Opening	Size
	Return/Supply	A	4"
	Primary LWCO & Gauge Glass Set	B	1/2"
	Drain, Left End	C	3/4"
	Drain, Right End	C	3/4"
	Plugged	D	1/2"
	Accessories	E	1"
	Safety Valve	F*	1"
	Plugged or Electronic (Probe Type) LWCO	G	3/4"
	*If using opening F for other than Safety Valve or Safety Relief Valve, or Safety/Relief valve is larger than 1", Install Safety/Relief Valve in Header Piping as near boiler as possible.		

JE - Cast Iron Commercial Steam Boiler

Model	Item Number	Type*	Input MBH	Output MBH	Net AHRI Ratings			Therm. Eff.	Shp. Wgt. Lbs	Trade Price
					Steam PPF	Steam SQ. FT.	Steam BTU (MBH)			
JE-300S	CBA030003101110	STD.	300	233	1.33	729	175	77.0%	1000	\$9,455
JE-400S	CBA040003101110	STD.	400	310	1.33	971	233	77.0%	1200	\$10,520
JE-500S	CBA050003101110	STD.	500	388	1.33	1213	291	77.0%	1400	\$11,833
JE-600S	CBA060003101110	STD.	600	465	1.33	1454	349	77.0%	1600	\$15,383
JE-700S	CBA070003101110	STD.	700	543	1.33	1696	407	77.0%	1800	\$16,574
JE-800S	CBA080003101110	STD.	800	620	1.33	1938	465	77.0%	2000	\$17,810
JE-900S	CBA090003101110	STD.	900	698	1.33	2183	524	77.0%	2200	\$19,116
JE-1000S	CBA100003101110	STD.	1000	775	1.33	2421	581	77.0%	2400	\$20,300
JE-1100S	CBA110003101110	STD.	1100	853	1.33	2667	640	77.0%	2600	\$23,947
JE-1200S	CBA120003101110	STD.	1200	930	1.33	2908	698	77.0%	2900	\$25,131
JE-1300S	CBA130003101110	STD.	1300	1008	1.33	3150	756	77.0%	3100	\$27,013
JE-1400S	CBA140003101110	STD.	1400	1085	1.33	3392	814	77.0%	3300	\$28,202
JE-1500S	CBA150003101110	STD.	1500	1163	1.33	3633	872	77.0%	3500	\$29,420
JE-300S	CBA030003103110	G.R.S.	300	233	1.33	729	175	77.0%	1000	\$10,558
JE-400S	CBA040003103110	G.R.S.	400	310	1.33	971	233	77.0%	1200	\$11,741
JE-500S	CBA050003103110	G.R.S.	500	388	1.33	1213	291	77.0%	1400	\$12,926
JE-600S	CBA060003103110	G.R.S.	600	465	1.33	1454	349	77.0%	1600	\$17,725
JE-700S	CBA070003103110	G.R.S.	700	543	1.33	1696	407	77.0%	1800	\$18,937
JE-800S	CBA080003103110	G.R.S.	800	620	1.33	1938	465	77.0%	2000	\$20,168
JE-900S	CBA090003103110	G.R.S.	900	698	1.33	2183	524	77.0%	2200	\$21,472
JE-1000S	CBA100003103110	G.R.S.	1000	775	1.33	2421	581	77.0%	2400	\$22,652
JE-1100S	CBA110003103110	G.R.S.	1100	853	1.33	2667	640	77.0%	2600	\$26,774
JE-1200S	CBA120003103110	G.R.S.	1200	930	1.33	2908	698	77.0%	2900	\$27,956
JE-1300S	CBA130003103110	G.R.S.	1300	1008	1.33	3150	756	77.0%	3100	\$29,832
JE-1400S	CBA140003103110	G.R.S.	1400	1085	1.33	3392	814	77.0%	3300	\$31,021
JE-1500S	CBA150003103110	G.R.S.	1500	1163	1.33	3633	872	77.0%	3500	\$32,235
JE-300S	CBA030003104110	F.P.R.	300	233	1.33	729	175	77.0%	1000	\$11,684
JE-400S	CBA040003104110	F.P.R.	400	310	1.33	971	233	77.0%	1200	\$12,868
JE-500S	CBA050003104110	F.P.R.	500	388	1.33	1213	291	77.0%	1400	\$14,060
JE-600S	CBA060003104110	F.P.R.	600	465	1.33	1454	349	77.0%	1600	\$18,857
JE-700S	CBA070003104110	F.P.R.	700	543	1.33	1696	407	77.0%	1800	\$20,065
JE-800S	CBA080003104110	F.P.R.	800	620	1.33	1938	465	77.0%	2000	\$21,296
JE-900S	CBA090003104110	F.P.R.	900	698	1.33	2183	524	77.0%	2200	\$22,599
JE-1000S	CBA100003104110	F.P.R.	1000	775	1.33	2421	581	77.0%	2400	\$23,782
JE-1100S	CBA110003104110	F.P.R.	1100	853	1.33	2667	640	77.0%	2600	\$27,901
JE-1200S	CBA120003104110	F.P.R.	1200	930	1.33	2908	698	77.0%	2900	\$29,087
JE-1300S	CBA130003104110	F.P.R.	1300	1008	1.33	3150	756	77.0%	3100	\$30,964
JE-1400S	CBA140003104110	F.P.R.	1400	1085	1.33	3392	814	77.0%	3300	\$32,151
JE-1500S	CBA150003104110	F.P.R.	1500	1163	1.33	3633	872	77.0%	3500	\$33,365

***Type (STD. - Standard) (G.R.S. - CSD-1 Gravity Return System) (F.P.R. - CSD-1 Boiler Feed Pump Return Control)**

JE - Knock Down Components & Optional Equipment			
Model	Item Number	Description	Trade Price
JE	41154050U	CAST IRON SECTIONS - RIGHT END (179 LBS.)	\$1,060
JE	41154051U	CAST IRON SECTIONS - LEFT END (182 LBS.)	\$1,060
JE	41154052U	CAST IRON SECTIONS - INTERMEDIATE (165 LBS.)	\$930
JE-300S	550002861U	COMPONENT CARTON - 300	\$2,828
JE-400S	550002862U	COMPONENT CARTON - 400	\$2,993
JE-500S	550002863U	COMPONENT CARTON - 500	\$3,143
JE-300S	550002890U	COMPONENT CARTON - 300 CSD-1	\$3,303
JE-400S	550002891U	COMPONENT CARTON - 400 CSD-1	\$3,470
JE-500S	550002892U	COMPONENT CARTON - 500 CSD-1	\$3,614
JE	550002871U	END PANEL CARTON - JACKET	\$412
JE	550002860U	END PANEL CARTON - BASE	\$375
JE	41200061U	STEAM TRIM - SA 1 (SIZES/MODELS: 300 - 500)	\$1,379
JE	41200062U	STEAM TRIM - SA 2 (SIZES/MODELS: 600 - 700)	\$1,400
JE	41200063U	STEAM TRIM - SA 3 (SIZES/MODELS: 800 - 1400)	\$1,437
JE	41200064U	STEAM TRIM - SA 4 (SIZES/MODELS: 1500)	\$1,450
JE-300S	550002877US	ACCESSORY CARTON - 300	\$484
JE-400S	550002878US	ACCESSORY CARTON - 400	\$569
JE-500S	550002867US	ACCESSORY CARTON - 500	\$686
JE-600S	550002879US	ACCESSORY CARTON - 600	\$776
JE-700S	550002880US	ACCESSORY CARTON - 700	\$868
JE-800S	550002881US	ACCESSORY CARTON - 800	\$1,008
JE-900S	550002882US	ACCESSORY CARTON - 900	\$1,196
JE-1000S	550002868US	ACCESSORY CARTON - 1000	\$1,305
JE-1100S	550002883US	ACCESSORY CARTON - 1100	\$1,493
JE-1200S	550002884US	ACCESSORY CARTON - 1200	\$1,566
JE-1300S	550002885US	ACCESSORY CARTON - 1300	\$2,389
JE-1400S	550002886US	ACCESSORY CARTON - 1400	\$2,485
JE-1500S	550002869US	ACCESSORY CARTON - 1500	\$2,622
JE	41257103U	CSD-1 STEAM TRIM - GRAVITY/CONDENSATE (ALL SIZES)	\$627
JE	41257104U	CSD-1 STEAM TRIM - FEED PUMP (ALL SIZES)	\$1,756
JE-300S	550002893US	CSD-1 ACCESSORY CARTON - 300	\$484
JE-400S	550002894US	CSD-1 ACCESSORY CARTON - 400	\$569
JE-500S	550002895US	CSD-1 ACCESSORY CARTON - 500	\$686
JE-600S	550002896US	CSD-1 ACCESSORY CARTON - 600	\$1,549
JE-700S	550002897US	CSD-1 ACCESSORY CARTON - 700	\$1,663
JE-800S	550002898US	CSD-1 ACCESSORY CARTON - 800	\$1,764
JE-900S	550002899US	CSD-1 ACCESSORY CARTON - 900	\$1,991
JE-1000S	550002900US	CSD-1 ACCESSORY CARTON - 1000	\$2,099
JE-1100S	550002901US	CSD-1 ACCESSORY CARTON - 1100	\$2,283
JE-1200S	550002902US	CSD-1 ACCESSORY CARTON - 1200	\$2,376
JE-1300S	550002903US	CSD-1 ACCESSORY CARTON - 1300	\$3,194
JE-1400S	550002904US	CSD-1 ACCESSORY CARTON - 1400	\$3,291
JE-1500S	550002905US	CSD-1 ACCESSORY CARTON - 1500	\$3,390

JE (Use Parts Multiplier for All of the Following)

Model	Item Number	Description	Trade Price
JE	14662311	STEAM MANUAL RESET PRESSURE CONTROL (L4079B1033)	\$386
JE	1280001	M-M 47-2 LWCO & FEEDER (MODELS 300-1500)	\$1,734
JE	14662313	STRAP ON OPERATING CONTROL (L6006C-1034)	\$233
JE	240007388	LWCO, MAN RESET, CSD-1 APPROVED, SHT PROBE	\$307

JE- Standard Equipment

Standard Equipment:

(67 Low Water Cut-Off, PA404A Pressuretrol and Syphon Loop, Water Gauge Glass Set with Glass and Rods, Steam Gauge, Pop Safety Valve).

CSD-1 Control Requirements

The optional CSD-1 controls modify the standard JE boiler on both the fuel train and the steam trim as follows:

STEAM BOILER WITH BOILER FEED PUMP RETURN SYSTEM

- Add SF-500 Hydrolevel Safeguard Manual Reset L.W.C.O.
- Add 150S-B-MD L.W.C.O. and Pump Control
- Delete 67D-1 L.W.C.O.
- Add L404L Manual Reset Pressure Control

STEAM BOILER WITH GRAVITY OR CONDENSATE PUMP RETURN SYSTEM

- Add SF-500 Hydrolevel Safeguard Manual Reset L.W.C.O.
- Add L404C Manual Reset Pressure Control

The SF-500 L.W.C.O. is the secondary L.W.C.O. to the 67D-1 L.W.C.O. furnished standard with the boiler.

FUEL TRAIN

Substitute CSD-1 fuel train(s) for standard which includes (per base): Intermittent Pilot Module (PT#1140007) control Stop w/alarm 1003-612A & (PT#1140008) Control CSD1 Lockout Board BD 1145-2 with manual reset; Independent Pilot Gas Line (Manual shut-off valve, Pressure regulator, Safety shut-off valve); Main Gas Line (Gas Valve, Two leak test cocks, Manual shut-off downstream of the main gas valve).

NOTES:

1. The JE-300 and JE-400 do not require fuel train modifications for CSD-1. The standard fuel train is furnished.
2. Control equipment is included to meet Utica's interpretation of CSD-1. Consult local authorities before the installation of the boiler. Additional controls, if required can be provided at an additional price.

TRIFIRE TRB Cast Iron 3-Pass Oil Boilers

- MBH Input 105 - 252 (CH)
- Up to 87% AFUE, ENERGY STAR® Certified Models
- Advanced High Efficiency 3-Pass Heat Exchanger Design
- High Limit Control with:
 - LED display
 - Easy to program dial settings
 - Boiler Water Temperature Reset
 - Low Water Cut Off (LWCO)
- Compact Footprint
- Burners and Venting Options
- Easy Serviceability



General Information (See IOM for Complete Instructions)				
Model	TRB4	TRB5	TRB6	TRB7
Water Return/Supply	1 1/4" NPT			
Drain Valve	3/4" NPT			
Electrical	120 Volts AC, 60 hertz, 1 phase, less than 12 amps (15 amp circuit recommended)			
Water Content (Gallons)	3.6	4.3	5.1	5.9
Dimensions	A-Height	31"	31"	31"
	B-Width	17 3/4"	17 3/4"	17 3/4"
	C-Depth	18 3/8"	21 5/8"	24 7/8"

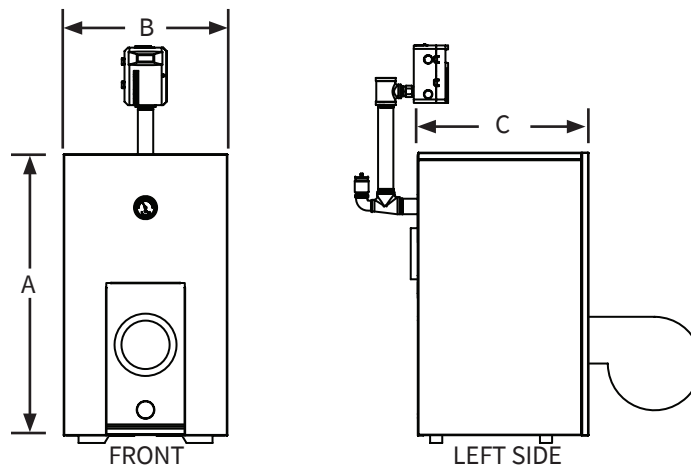

DHW MODULE Domestic Hot Water Module (Sold Separately)

- The Domestic Hot Water (DHW) Module is a great way to make domestic hot water using an existing boiler
- Digital control has the ability to set a consistent DHW temperature from 108°F - 140°F
- Brazed plate stainless steel heat exchanger offers lower pressure drop than tankless water coils with nearly 100% heat transfer efficiency
- Simple and flexible installation - mounts on a wall near the boiler as an additional heating zone
- Compact design with insulated cover and a standard 120 volt power cord
- Easy to service and clean



TRIFIRE TRB Series 3 - Cast Iron 3-Pass Oil Boiler										
Model	Item Number	Input MBH	Htg. Cap. MBH	AHRI Net MBH	AFUE	Fuel	Burner	Pump	Shp. Wgt. lbs	Trade Price
TRB4075	TRB407530200310	105	92	80	87.0%	OIL	BECKETT	LESS	436	\$4,010
TRB4090	TRB409030200310	126	110	96	86.0%	OIL	BECKETT	LESS	436	\$4,010
TRB5100	TRB510030200310	140	123	107	87.0%	OIL	BECKETT	LESS	496	\$4,579
TRB5120	TRB512030200310	168	148	129	86.0%	OIL	BECKETT	LESS	496	\$4,579
TRB6130	TRB613030200310	182	160	139	87.0%	OIL	BECKETT	LESS	560	\$4,833
TRB6145	TRB614530200310	203	178	155	86.0%	OIL	BECKETT	LESS	560	\$4,833
TRB7165	TRB716530200310	231	202	176	87.0%	OIL	BECKETT	LESS	620	\$5,528
TRB7180	TRB718030200310	252	220	191	86.0%	OIL	BECKETT	LESS	620	\$5,528
TRB4075	TRB407530240310	105	92	80	87.0%	OIL	BECKETT	TACO ECM	436	\$4,133
TRB4090	TRB409030240310	126	110	96	86.0%	OIL	BECKETT	TACO ECM	436	\$4,133
TRB5100	TRB510030240310	140	123	107	87.0%	OIL	BECKETT	TACO ECM	496	\$4,702
TRB5120	TRB512030240310	168	148	129	86.0%	OIL	BECKETT	TACO ECM	496	\$4,702
TRB6130	TRB613030240310	182	160	139	87.0%	OIL	BECKETT	TACO ECM	560	\$4,957
TRB6145	TRB614530240310	203	178	155	86.0%	OIL	BECKETT	TACO ECM	560	\$4,957
TRB7165	TRB716530240310	231	202	176	87.0%	OIL	BECKETT	TACO ECM	620	\$5,651
TRB7180	TRB718030240310	252	220	191	86.0%	OIL	BECKETT	TACO ECM	620	\$5,651
TRB4075	TRB407530220310	105	92	80	87.0%	OIL	BECKETT	GRUNDFOS	436	\$4,133
TRB4090	TRB409030220310	126	110	96	86.0%	OIL	BECKETT	GRUNDFOS	436	\$4,133
TRB5100	TRB510030220310	140	123	107	87.0%	OIL	BECKETT	GRUNDFOS	496	\$4,702
TRB5120	TRB512030220310	168	148	129	86.0%	OIL	BECKETT	GRUNDFOS	496	\$4,702
TRB6130	TRB613030220310	182	160	139	87.0%	OIL	BECKETT	GRUNDFOS	560	\$4,957
TRB6145	TRB614530220310	203	178	155	86.0%	OIL	BECKETT	GRUNDFOS	560	\$4,957
TRB7165	TRB716530220310	231	202	176	87.0%	OIL	BECKETT	GRUNDFOS	620	\$5,651
TRB7180	TRB718030220310	252	220	191	86.0%	OIL	BECKETT	GRUNDFOS	620	\$5,651
TRB4075	TRB407550200310	105	92	80	87.0%	OIL	RIELLO	LESS	436	\$4,192
TRB4090	TRB409050200310	126	110	96	86.0%	OIL	RIELLO	LESS	436	\$4,192
TRB5100	TRB510050200310	140	123	107	87.0%	OIL	RIELLO	LESS	496	\$4,834
TRB5120	TRB512050200310	168	148	129	86.0%	OIL	RIELLO	LESS	496	\$4,834
TRB6130	TRB613050200310	182	160	139	87.0%	OIL	RIELLO	LESS	560	\$5,089
TRB6145	TRB614550200310	203	178	155	86.0%	OIL	RIELLO	LESS	560	\$5,089
TRB7165	TRB716550200310	231	202	176	87.0%	OIL	RIELLO	LESS	620	\$5,528
TRB7180	TRB718050200310	252	220	191	86.0%	OIL	RIELLO	LESS	620	\$5,528
TRB4075	TRB407550240310	105	92	80	87.0%	OIL	RIELLO	TACO ECM	436	\$4,314
TRB4090	TRB409050240310	126	110	96	86.0%	OIL	RIELLO	TACO ECM	436	\$4,314
TRB5100	TRB510050240310	140	123	107	87.0%	OIL	RIELLO	TACO ECM	496	\$4,958
TRB5120	TRB512050240310	168	148	129	86.0%	OIL	RIELLO	TACO ECM	496	\$4,958
TRB6130	TRB613050240310	182	160	139	87.0%	OIL	RIELLO	TACO ECM	560	\$5,214
TRB6145	TRB614550240310	203	178	155	86.0%	OIL	RIELLO	TACO ECM	560	\$5,214
TRB7165	TRB716550240310	231	202	176	87.0%	OIL	RIELLO	TACO ECM	620	\$5,675
TRB7180	TRB718050240310	252	220	191	86.0%	OIL	RIELLO	TACO ECM	620	\$5,675

DOMESTIC HOT WATER (DHW) MODULE			
Model	Item Number	Description	Trade Price
550003792	550003792U	DOMESTIC HOT WATER MODULE	\$1,183

TRIFIRE TRB Series 3 - Cast Iron 3-Pass Oil Boiler - Continued

Model	Item Number	Input MBH	Htg. Cap. MBH	AHRI Net MBH	AFUE	Fuel	Burner	Pump	Shp. Wgt. lbs	Trade Price
TRB4075	TRB407550220310	105	92	80	87.0%	OIL	RIELLO	GRUNDFOS	436	\$4,314
TRB4090	TRB409050220310	126	110	96	86.0%	OIL	RIELLO	GRUNDFOS	436	\$4,314
TRB5100	TRB510050220310	140	123	107	87.0%	OIL	RIELLO	GRUNDFOS	496	\$4,958
TRB5120	TRB512050220310	168	148	129	86.0%	OIL	RIELLO	GRUNDFOS	496	\$4,958
TRB6130	TRB613050220310	182	160	139	87.0%	OIL	RIELLO	GRUNDFOS	560	\$5,214
TRB6145	TRB614550220310	203	178	155	86.0%	OIL	RIELLO	GRUNDFOS	560	\$5,214
TRB7165	TRB716550220310	231	202	176	87.0%	OIL	RIELLO	GRUNDFOS	620	\$5,675
TRB7180	TRB718050220310	252	220	191	86.0%	OIL	RIELLO	GRUNDFOS	620	\$5,675
TRB4090	TRB409020240310	126	110	96	87.0%	OIL	LESS	TACO ECM	436	\$3,112
TRB5120	TRB512020240310	168	148	129	86.0%	OIL	LESS	TACO ECM	496	\$3,624
TRB6145	TRB614520240310	203	178	155	86.0%	OIL	LESS	TACO ECM	560	\$3,984
TRB7180	TRB718020240310	252	220	191	86.0%	OIL	LESS	TACO ECM	620	\$4,454
TRB4090	TRB409020200310	126	110	96	87.0%	OIL	LESS	LESS	436	\$2,987
TRB5120	TRB512020200310	168	148	129	86.0%	OIL	LESS	LESS	496	\$3,501
TRB6145	TRB614520200310	203	178	155	86.0%	OIL	LESS	LESS	560	\$3,862
TRB7180	TRB718020200310	252	220	191	86.0%	OIL	LESS	LESS	620	\$4,334

TRIFIRE TRB - Venting Options & Additional Equipment

Model	Item Number	Description	Trade Price
TRB	29231U	36" RISER TERMINATION	\$1,819
TRB	28972U	STANDARD TERMINATION	\$776
TRB	550004240U	4" ID X 10 FT DIRECT VENT PIPE KIT (SELECT TERMINATION)	\$894
TRB	550004241U	4" ID X 15 FT DIRECT VENT PIPE KIT (SELECT TERMINATION)	\$1,071
TRB	550004242U	4" ID X 20 FT DIRECT VENT PIPE KIT (SELECT TERMINATION)	\$1,262

TRIFIRE TRB - Replacement Oil Burners

TRB4075	240007232U	BECKETT CHIMNEY VENT W/O COVER MODEL AFG	\$962
TRB4090	240013303U	BECKETT CHIMNEY VENT W/O COVER MODEL AFG	\$962
TRB5100	240013393U	BECKETT CHIMNEY VENT W/O COVER MODEL AFG	\$1,077
TRB5120	240013395U	BECKETT CHIMNEY VENT W/O COVER MODEL AFG	\$1,077
TRB6130	240013397U	BECKETT CHIMNEY VENT W/O COVER MODEL AFG	\$1,077
TRB6145	240013399U	BECKETT CHIMNEY VENT W/O COVER MODEL AFG	\$1,077
TRB7165	240013401U	BECKETT CHIMNEY VENT W/O COVER MODEL AFG	\$1,077
TRB7180	240013403U	BECKETT CHIMNEY VENT W/O COVER MODEL AFG	\$1,077
TRB4075	240007144U	BECKETT CHIMNEY VENT WITH COVER MODEL AFG	\$1,027
TRB4090	240013302U	BECKETT CHIMNEY VENT WITH COVER MODEL AFG	\$1,027
TRB5100	240013394U	BECKETT CHIMNEY VENT WITH COVER MODEL AFG	\$1,138
TRB5120	240013396U	BECKETT CHIMNEY VENT WITH COVER MODEL AFG	\$1,138
TRB6130	240013398U	BECKETT CHIMNEY VENT WITH COVER MODEL AFG	\$1,138
TRB6145	240013400U	BECKETT CHIMNEY VENT WITH COVER MODEL AFG	\$1,138
TRB7165	240013402U	BECKETT CHIMNEY VENT WITH COVER MODEL AFG	\$1,138
TRB7180	240013404U	BECKETT CHIMNEY VENT WITH COVER MODEL AFG	\$1,138
TRB4075	550004238U	BECKETT DIRECT VENT MODEL NX	\$1,229
TRB5100	240007532U	BECKETT DIRECT VENT MODEL NX	\$1,280
TRB6130	240007533U	BECKETT DIRECT VENT MODEL NX	\$1,182

TRIFIRE TRB - Replacement Oil Burners - Continued			
Model	Item Number	Description	Trade Price
TRB4075	550003548U	RIELLO CHIMNEY VENT MODEL 40F3	\$1,133
TRB4090	550004237U	RIELLO CHIMNEY VENT MODEL 40F3	\$1,133
TRB5100	550004287U	RIELLO CHIMNEY VENT MODEL 40F5	\$1,133
TRB5120	550004290U	RIELLO CHIMNEY VENT MODEL 40F5	\$1,133
TRB6130	550004288U	RIELLO CHIMNEY VENT MODEL 40F5	\$1,133
TRB6145	550004291U	RIELLO CHIMNEY VENT MODEL 40F5	\$1,133
TRB7165	550004289U	RIELLO CHIMNEY VENT MODEL 40F10	\$1,470
TRB7180	550004292U	RIELLO CHIMNEY VENT MODEL 40F10	\$1,470
TRB4075	550004239U	RIELLO DIRECT VENT MODEL 40BF	\$1,654
TRB5100	550003563U	RIELLO DIRECT VENT MODEL 40BF	\$1,780
TRB6130	550003566U	RIELLO DIRECT VENT MODEL 40BF	\$1,677
TRB4075	240013299U	CARLIN CHIMNEY VENT EZ-LF	\$1,036
TRB4090	240013299U	CARLIN CHIMNEY VENT EZ-LF	\$1,036
TRB5100	240013406U	CARLIN CHIMNEY VENT EZ-LF	\$1,158
TRB5120	240013406U	CARLIN CHIMNEY VENT EZ-LF	\$1,158
TRB6130	240013408U	CARLIN CHIMNEY VENT EZ-LF	\$1,158
TRB6145	240013408U	CARLIN CHIMNEY VENT EZ-LF	\$1,158
TRIFIRE TRB (Use Parts Multiplier for All of the Following)			
TRB	550001929	KIT, HIGH LIMIT MANUAL RESET L4006E1109 WITH PLUG IN HARNESS	\$321
TRB	14624002	FILL-TROL FOR WATER BOILERS 150 MBH OR LESS	\$421
TRB	14624003	FILL-TROL FOR WATER BOILERS OVER 150 MBH	\$585

STARFIRE SFH Cast Iron Chimney Vented Oil Boilers

- MBH Input 119 - 259 (CH)
- Up to 87% AFUE
- Dependable Cast Iron Heat Exchanger with Cast Iron Push Nipples
- Hydrolevel Operating Control
 - Digital Temperature display and diagnostics
 - Adjusts water temperature based on heating system demand
 - Built-In Low Water Cut-Off (LWCO)
 - Boiler Reset
- Burner swing door for easy serviceability
- Multiple Firing Rates
- Optional tankless domestic hot water (DHW) coil



General Information (See IOM for Complete Instructions)				
Model	SFH-3085WT	SFH-4100WT SFH-4125WT	SFH-5160WT	SFH-6175WT
Water Return/Supply	1 1/2" Return NPT, 2" Supply NPT			
Oil	3/8" O.D. Copper (runs 50' or less, 1/2" O.D. Copper (runs over 50')			
Electrical	120 Volts AC, 60 hertz, 1 phase, less than 12 amps (15 amp circuit recommended)			
Water Content (Gallons)	10.5	13.5	16.5	19.5
Dimensions	A-Height	35"	35"	35"
	B-Width	21 13/16"	21 13/16"	21 13/16"
	C-Depth	17 7/8"	21 1/2"	25 1/8"

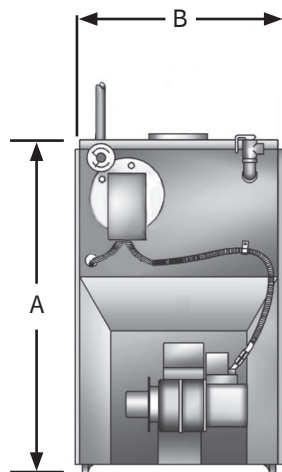

FRONT

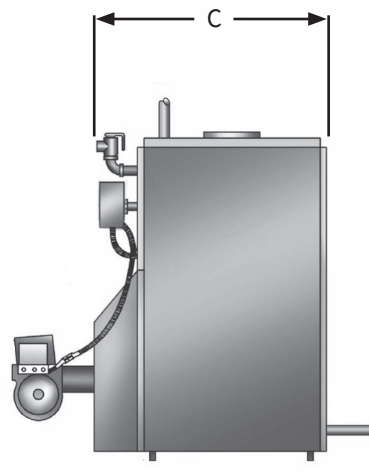

RIGHT SIDE

STARFIRE SFH - Cast Iron Chimney Vent Oil Boiler											
Model	Item Number	Type *	Input MBH	Htg. Cap. MBH	AHRI Net MBH	AFUE	Burner	Pump	Firing Rate GPH	Shp. Wgt. Lbs	Trade Price
SFH-3085W	SFH308530200510	C.O.	119	103	90	86.0%	BECKETT	LESS	0.85	534	\$4,948
SFH-4100W	SFH410030200510	C.O.	140	124	108	87.0%	BECKETT	LESS	1.00	668	\$5,204
SFH-4125W	SFH412530200510	C.O.	175	152	132	86.0%	BECKETT	LESS	1.25	668	\$5,204
SFH-5160W	SFH516030200510	C.O.	224	195	170	86.0%	BECKETT	LESS	1.60	781	\$6,333
SFH-6185W	SFH618530200510	C.O.	259	226	197	86.0%	BECKETT	LESS	1.85	901	\$6,923
SFH-3085W	SFH308530240510	C.O.	119	103	90	86.0%	BECKETT	TACO ECM	0.85	534	\$5,059
SFH-4100W	SFH410030240510	C.O.	140	124	108	87.0%	BECKETT	TACO ECM	1.00	668	\$5,315
SFH-4125W	SFH412530240510	C.O.	175	152	131	86.0%	BECKETT	TACO ECM	1.25	668	\$5,315
SFH-5160W	SFH516030240510	C.O.	224	195	170	86.0%	BECKETT	TACO ECM	1.60	781	\$6,439
SFH-6185W	SFH618530240510	C.O.	259	226	197	86.0%	BECKETT	TACO ECM	1.85	901	\$7,030
SFH-3085W	SFH308530220510	C.O.	119	103	90	86.0%	BECKETT	GRUNDFOS	0.85	534	\$5,059
SFH-4100W	SFH410030220510	C.O.	140	124	108	87.0%	BECKETT	GRUNDFOS	1.00	668	\$5,315
SFH-4125W	SFH412530220510	C.O.	175	152	132	86.0%	BECKETT	GRUNDFOS	1.25	668	\$5,315
SFH-5160W	SFH516030220510	C.O.	224	195	170	86.0%	BECKETT	GRUNDFOS	1.60	781	\$6,439
SFH-6185W	SFH618530220510	C.O.	259	226	197	86.0%	BECKETT	GRUNDFOS	1.85	901	\$7,030
SFH-3085W	SFH308531200510	C.P.	119	103	90	86.0%	BECKETT	LESS	0.85	534	\$5,144
SFH-4100W	SFH410031200510	C.P.	140	124	108	87.0%	BECKETT	LESS	1.00	668	\$5,399
SFH-4125W	SFH412531200510	C.P.	175	152	132	86.0%	BECKETT	LESS	1.25	668	\$5,399
SFH-5160W	SFH516031200510	C.P.	224	195	170	86.0%	BECKETT	LESS	1.60	781	\$6,545
SFH-6185W	SFH618531200510	C.P.	259	226	197	86.0%	BECKETT	LESS	1.85	901	\$6,868
SFH-3085W	SFH308531240510	C.P.	119	103	90	86.0%	BECKETT	TACO ECM	0.85	534	\$5,255
SFH-4100W	SFH410031240510	C.P.	140	124	108	87.0%	BECKETT	TACO ECM	1.00	668	\$5,510
SFH-4125W	SFH412531240510	C.P.	175	152	132	86.0%	BECKETT	TACO ECM	1.25	668	\$5,510
SFH-5160W	SFH516031240510	C.P.	224	195	170	86.0%	BECKETT	TACO ECM	1.60	781	\$6,652
SFH-6185W	SFH618531240510	C.P.	259	226	197	86.0%	BECKETT	TACO ECM	1.85	901	\$6,974

***TYPE (C.O. - CAST OVER) (C.P. - WITH COVER PLATE) (T.C. - TANKLESS COIL)**

STARFIRE SFH - Cast Iron Chimney Vent Oil Boiler (Cont.)

Model	Item Number	Type *	Input MBH	Htg. Cap. MBH	AHRI Net MBH	AFUE	Burner	Pump	Firing Rate GPH	Shp. Wgt. Lbs	Trade Price
SFH-3085W	SFH308531220510	C.P.	119	103	90	86.0%	BECKETT	GRUNDFOS	0.85	534	\$5,255
SFH-4100W	SFH410031220510	C.P.	140	124	108	87.0%	BECKETT	GRUNDFOS	1.00	668	\$5,510
SFH-4125W	SFH412531220510	C.P.	175	152	132	86.0%	BECKETT	GRUNDFOS	1.25	668	\$5,510
SFH-5160W	SFH516031220510	C.P.	224	195	170	86.0%	BECKETT	GRUNDFOS	1.60	781	\$6,652
SFH-6185W	SFH618531220510	C.P.	259	226	197	86.0%	BECKETT	GRUNDFOS	1.85	901	\$6,974
SFH-3085WT	SFH308532200510	T.C.	119	103	90	86.0%	BECKETT	LESS	0.85	534	\$5,383
SFH-4100WT	SFH410032200510	T.C.	140	124	108	87.0%	BECKETT	LESS	1.00	668	\$5,637
SFH-4125WT	SFH412532200510	T.C.	175	152	132	86.0%	BECKETT	LESS	1.25	668	\$5,637
SFH-5160WT	SFH516032200510	T.C.	224	195	170	86.0%	BECKETT	LESS	1.60	781	\$6,756
SFH-6185WT	SFH618532200510	T.C.	259	226	197	86.0%	BECKETT	LESS	1.85	901	\$7,223
SFH-3085WT	SFH308532240510	T.C.	119	103	90	86.0%	BECKETT	TACO ECM	0.85	534	\$5,495
SFH-4100WT	SFH410032240510	T.C.	140	124	108	87.0%	BECKETT	TACO ECM	1.00	668	\$5,751
SFH-4125WT	SFH412532240510	T.C.	175	152	132	86.0%	BECKETT	TACO ECM	1.25	668	\$5,751
SFH-5160WT	SFH516032240510	T.C.	224	195	170	86.0%	BECKETT	TACO ECM	1.60	781	\$6,864
SFH-6185WT	SFH618532240510	T.C.	259	226	197	86.0%	BECKETT	TACO ECM	1.85	901	\$7,330
SFH-3085WT	SFH308532220510	T.C.	119	103	90	86.0%	BECKETT	GRUNDFOS	0.85	534	\$5,495
SFH-4100WT	SFH410032220510	T.C.	140	124	108	87.0%	BECKETT	GRUNDFOS	1.00	668	\$5,751
SFH-4125WT	SFH412532220510	T.C.	175	152	132	86.0%	BECKETT	GRUNDFOS	1.25	668	\$5,751
SFH-5160WT	SFH516032220510	T.C.	224	195	170	86.0%	BECKETT	GRUNDFOS	1.60	781	\$6,864
SFH-6185WT	SFH618532220510	T.C.	259	226	197	86.0%	BECKETT	GRUNDFOS	1.85	901	\$7,330
SFH-3085W	SFH308520200510	C.O.	140	103	90	86.0%	LESS	LESS	1.00	534	\$3,657
SFH-4125W	SFH412520200510	C.O.	175	175	132	86.0%	LESS	LESS	1.45	668	\$3,913
SFH-5160W	SFH516020200510	C.O.	224	195	170	86.0%	LESS	LESS	1.85	781	\$5,103
SFH-6185W	SFH618520200510	C.O.	259	226	197	86.0%	LESS	LESS	2.10	901	\$5,693
SFH-3085W	SFH308520240510	C.O.	140	103	90	86.0%	LESS	TACO ECM	1.00	534	\$3,770
SFH-4125W	SFH412520240510	C.O.	175	175	132	86.0%	LESS	TACO ECM	1.45	668	\$4,024
SFH-5160W	SFH516020240510	C.O.	224	195	170	86.0%	LESS	TACO ECM	1.85	781	\$5,210
SFH-6185W	SFH618520240510	C.O.	259	226	197	86.0%	LESS	TACO ECM	2.10	901	\$5,801
SFH-3085W	SFH308520220510	C.O.	140	103	103	86.0%	LESS	GRUNDFOS	1.00	534	\$3,770
SFH-4125W	SFH412520220510	C.O.	175	175	132	86.0%	LESS	GRUNDFOS	1.45	668	\$4,024
SFH-5160W	SFH516020220510	C.O.	224	195	170	86.0%	LESS	GRUNDFOS	1.85	781	\$5,210
SFH-6185W	SFH618520220510	C.O.	259	226	197	86.0%	LESS	GRUNDFOS	2.10	901	\$5,801

***TYPE (C.O. - CAST OVER) (C.P. - WITH COVER PLATE) (T.C. - TANKLESS COIL)**

STARFIRE SFH - Cast Iron Chimney Vent Oil Boiler (Cont.)

Model	Item Number	Type *	Input MBH	Htg. Cap. MBH	AHRI Net MBH	AFUE	Burner	Pump	Firing Rate GPH	Shp. Wgt. Lbs	Trade Price
SFH-3085W	SFH308521200510	C.P.	140	103	90	86.0%	LESS	LESS	1.00	534	\$3,854
SFH-4125W	SFH412521200510	C.P.	175	175	132	86.0%	LESS	LESS	1.45	668	\$4,109
SFH-5160W	SFH516021200510	C.P.	224	195	170	86.0%	LESS	LESS	1.85	781	\$5,316
SFH-6185W	SFH618521200510	C.P.	259	226	197	86.0%	LESS	LESS	2.10	901	\$5,639
SFH-3085W	SFH308521240510	C.P.	140	103	90	86.0%	LESS	TACO ECM	1.00	534	\$3,966
SFH-4125W	SFH412521240510	C.P.	175	175	132	86.0%	LESS	TACO ECM	1.45	668	\$4,220
SFH-5160W	SFH516021240510	C.P.	224	195	170	86.0%	LESS	TACO ECM	1.85	781	\$5,422
SFH-6185W	SFH618521240510	C.P.	259	226	197	86.0%	LESS	TACO ECM	2.10	901	\$5,745
SFH-3085W	SFH308521220510	C.P.	140	103	90	86.0%	LESS	GRUNDFOS	1.00	534	\$3,966
SFH-4125W	SFH412521220510	C.P.	175	175	132	86.0%	LESS	GRUNDFOS	1.45	668	\$4,220
SFH-5160W	SFH516021220510	C.P.	224	195	170	86.0%	LESS	GRUNDFOS	1.85	781	\$5,422
SFH-6185W	SFH618521220510	C.P.	259	226	197	86.0%	LESS	GRUNDFOS	2.10	901	\$5,745
SFH-3085WT	SFH308522200510	T.C.	140	103	90	86.0%	LESS	LESS	1.00	534	\$4,092
SFH-4125WT	SFH412522200510	T.C.	175	175	132	86.0%	LESS	LESS	1.45	668	\$4,347
SFH-5160WT	SFH516022200510	T.C.	224	195	170	86.0%	LESS	LESS	1.85	781	\$5,529
SFH-6185WT	SFH618522200510	T.C.	259	226	197	86.0%	LESS	LESS	2.10	901	\$5,994
SFH-3085WT	SFH308522240510	T.C.	140	103	90	86.0%	LESS	TACO ECM	1.00	534	\$4,204
SFH-4125WT	SFH412522240510	T.C.	175	175	132	86.0%	LESS	TACO ECM	1.45	668	\$4,457
SFH-5160WT	SFH516022240510	T.C.	224	195	170	86.0%	LESS	TACO ECM	1.85	781	\$5,634
SFH-6185WT	SFH618522240510	T.C.	259	226	197	86.0%	LESS	TACO ECM	2.10	901	\$6,101
SFH-3085WT	SFH308522220510	T.C.	140	103	90	86.0%	LESS	GRUNDFOS	1.00	534	\$4,204
SFH-4125WT	SFH412522220510	T.C.	175	175	132	86.0%	LESS	GRUNDFOS	1.45	668	\$4,457
SFH-5160WT	SFH516022220510	T.C.	224	195	170	86.0%	LESS	GRUNDFOS	1.85	781	\$5,634
SFH-6185WT	SFH618522220510	T.C.	259	226	197	86.0%	LESS	GRUNDFOS	2.10	901	\$6,101

*TYPE (C.O. - CAST OVER) (C.P. - WITH COVER PLATE) (T.C. - TANKLESS COIL)

STARFIRE SFH (Use Parts Multiplier for All of the Following)

Model	Item Number	Description	Trade Price
SFH-4125	550004116	4100/4125 BECKETT RERATE KIT	\$101
SFH-3085	550004100	SFH-3085 BECKETT BURNER IN A BOX KIT	\$1,290
SFH-4125	550004101	SFH-4100/4125 BECKETT BURNER IN A BOX KIT	\$1,290
SFH-5160	550004102	SFH-5160 BECKETT BURNER IN A BOX KIT	\$1,290
SFH-6185	550004103	SFH-6185 BECKETT BURNER IN A BOX KIT	\$1,290
SFH	550004104	SFH-3085/4100/4125/5160 RIELLO40F5 BURNER BOX KIT	\$1,548
SFH	550004105	SFH-6185 RIELLO 40F10 BURNER IN A BOX KIT	\$2,053
SFH	550004106	SFH-3085/4100/4125 CARLIN EZ1-HP BURNER IN A BOX KIT	\$1,290
SFH	550004107	SFH-5160/6185 CARLIN EZ2-HP BURNER IN A BOX KIT	\$1,290

SBO Cast Iron Steam Oil Boilers

- MBH Input 119 - 210 (CH)
- Up to 85.6% AFUE
- Dependable Cast Iron Heat Exchanger
- Cast Iron Swing out Burner Door and large flueways allow for easy cleaning and servicing
- Honeywell Pressure Control, Boiler Water Level Gauge Glass, and Steam Pressure Gauge
- Electronic Low Water Cutoff (LWCO)
- Atmospheric Chimney Vent Boiler



General Information (See IOM for Complete Instructions)				
Model	SBO-3085	SBO-3105	SBO-4125	SBO-4150
Return/Supply Tappings	1 1/4" Return NPT, 2" Supply NPT			
Oil	3/8" O.D. Copper (runs 50' or less, 1/2" O.D. Copper (runs over 50')			
Electrical	120 Volts AC, 60 hertz, 1 phase, less than 12 amps (15 amp circuit recommended)			
Water Content (Gallons)	12	12	14.87	14.87
Dimensions	A-Height	35"	35"	35"
	B-Width	22 1/8"	22 1/8"	22 1/8"
	C-Depth	15 3/4"	15 3/4"	19 3/4"

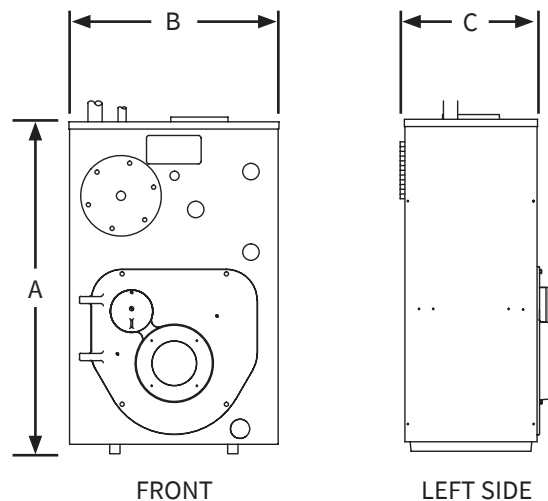

SBO - Cast Iron Steam Oil Boiler Less Burner

Model	Item Number	Type	Input MBH	Htg. Cap. MBH	AHRI Net MBH	AHRI Net Sq. Ft.	AFUE	Burner	Firing Rate GPH	Shp. Wgt. lbs	Trade Price
SBO-3105	SBO310521700110	LESS	147	127	95	396	85.0%	LESS	1.05	538	\$4,530
SBO-4150	SBO415021700110	LESS	210	180	135	563	85.0%	LESS	1.50	650	\$5,324

SBO (Use Equipment Multiplier for All of the Following)

Model	Item Number	Description	Trade Price
SBO	550004158U	TANKLESS COIL KIT WITH CONTROL	\$623
SBO-3105	550004153U	SBO-3105 BECKETT BURNER IN A BOX KIT	\$1,030
SBO-4150	550004154U	SBO-4150 BECKETT BURNER IN A BOX KIT	\$1,030

Please Note: Oil Fired Steam Boilers are sold less burner. Please add burner in a box kit to your order.

Tankless Coil Kits are sold separately.

SBO (Use Parts Multiplier for All of the Following)

Model	Item Number	Description	Trade Price
SBO	550004155	3085/3105 BECKETT RERATE KIT	\$166
SBO	550004156	4125/4150 BECKETT RERATE KIT	\$166

H2O GL Single Coil Glass Lined Indirect Water Heaters

- 31 - 106 Gallon Capacities
- Easy to Install
- Low Pressure Drop
- Magnesium Anode Rod Corrosion Protection
- Enameled Coated Steel Tank and Coil
- Minimal Standby Losses
- Flexible Scratch Resistant Jacket
- Aquastat Sensor Well
- Temperature Pressure Relief Valve



(H2O40GL Model Shown)

General Information (See IOM for Complete Instructions)					
Maximum Working Pressure: 150 psi for all Capacities					
Model	Piping Connections NPT		Dimensions		
	Domestic Water In/Out	Boiler Water In/Out	Diameter	Height	Weight
H2O 30 GL	1"	1"	24"	33"	119 lbs
H2O 40 GL	1"	1"	24"	45"	180 lbs
H2O 50 GL	1"	1"	24"	51"	200 lbs
H2O 80 GL	1"	1"	30"	48"	243 lbs
H2O 105 GL	1"	1"	30"	62"	393 lbs

H2O GL - Single Coil Glass Lined Indirect Water Heaters								
Model	Item Number	Storage Capacity gal	Type	Max. First Hour Rating gal/hr @	Continuous Rating gal/hr @	Boiler Output Req. BTU/hr	Shp. Wgt. lbs	Trade Price
H2O 30 GL	H2OIG30UB	31	GLASS LINED	155	124	100,000	119	\$1,488
H2O 40 GL	H2OIG40UB	42	GLASS LINED	256	220	120,000	180	\$1,532
H2O 50 GL	H2OIG50UB	53	GLASS LINED	310	268	140,000	200	\$1,745
H2O 80 GL	H2OIG80UB	79	GLASS LINED	346	281	180,000	243	\$2,421
H2O 105 GL	H2OIG105UB	106	GLASS LINED	440	345	220,000	393	\$3,786

H2O GL (Use Parts Multiplier for All of the Following)			
Model	Item Number	Description	Trade Price
30-105 GAL.	240010926	T & P VALVE 3/4, 100XL-8	\$62
30-105 GAL.	AQ-020.01	AQUASTAT WELL	\$43
30-105 GAL.	240013432	AQUASTAT	\$171
30-50 GAL.	240012211	PLASTIC TOP CAP	\$34
80-105 GAL.	240012239	PLASTIC TOP CAP	\$47
40-105 GAL.	240012212	PLASTIC FRONT CAP	\$8
30 GAL.	550003640	ANODE KIT MAGNESIUM (INCLUDES ANODE, GASKET & BUSHING)	\$45
40-50 GAL.	550003505	ANODE KIT MAGNESIUM (INCLUDES ANODE, GASKET & BUSHING)	\$45
80-105 GAL.	550003527	ANODE KIT MAGNESIUM (INCLUDES ANODE, GASKET & BUSHING)	\$87
30 GAL.	550003693	ANODE KIT ALUMINUM (INCLUDES ANODE, GASKET & BUSHING)	\$44
40-50 GAL.	550003694	ANODE KIT ALUMINUM (INCLUDES ANODE, GASKET & BUSHING)	\$45
80-105 GAL.	550003695	ANODE KIT ALUMINUM (INCLUDES ANODE, GASKET & BUSHING)	\$87
30-50 GAL.	240012250	FLANGE CAP	\$47
80-105 GAL.	240012251	FLANGE CAP	\$18
30-50 GAL.	240012210	FLANGE GASKET	\$2
80-105 GAL.	240012238	FLANGE GASKET	\$4
40-50 GAL.	550003510	HARDWARE KIT (INCLUDES BOLTS & NUTS FOR FLANGE CAP)	\$4
80-105 GAL.	550003525	HARDWARE KIT (INCLUDES BOLTS & NUTS FOR FLANGE CAP)	\$4
H2O 30 GL	240012474	OUTSIDE TANK COVER	\$126
H2O 40 GL	240012329	OUTSIDE TANK COVER	\$128
H2O 50 GL	240012330	OUTSIDE TANK COVER	\$137
H2O 80 GL	240012331	OUTSIDE TANK COVER	\$149
H2O 105 GL	240012332	OUTSIDE TANK COVER	\$167
30-50 GAL.	240012483	TEMPERATURE GAUGE	\$19
80-105 GAL.	240012484	TEMPERATURE GAUGE	\$27

H2O SC Single Coil Stainless Steel Indirect Water Heaters

- 30 - 115 Gallon Capacities
- 316L Stainless Steel Construction
- Top Connections (For Easy Install)
- Stainless Steel Dip Tube
- Thermoplastic Jacket
- Low Pressure Drop
- T & P Valve, Stainless Steel Aquastat Well and Drain Valve
- 2.25" EPS Insulation
- Large Diameter, Smooth Coil Heat Exchangers - Prevent Buildup
- Honeywell L4080B Aquastat



H2O

I

Indirect

30

Capacity:
 30=30 gals
 40=40 gals
 50=50 gals
 60=60 gals
 80=80 gals
 85=87 gals
 115=115 gals

L

Type:
 L=Lowboy
 HO=High Output
 HOC=High Output
 Commercial
 XHO=Extra High
 Output

UB

UB=Utica

General Information (See IOM for Complete Instructions)					
Maximum Working Pressure: 150 psi for all Capacities					
Model	Piping Connections NPT		Dimensions		
	Domestic Water In/Out	Boiler Water In/Out	Diameter	Height	Weight
H2OI30UB	3/4"	1"	23 1/2"	34"	85 lbs
H2OI40UB	3/4"	1"	23 1/2"	44"	100 lbs
H2OI40LUB	3/4"	1"	28"	36"	100 lbs
H2OI50UB	3/4"	1"	23 1/2"	54"	110 lbs
H2OI60UB	3/4"	1"	23 1/2"	62"	125 lbs
H2OI60LUB	3/4"	1"	28"	46"	120 lbs
H2OI80UB	1"	1"	28"	56"	140 lbs
H2OI115UB	1"	1"	28"	74"	175 lbs
High Output Units					
H2OI60HOUB	1"	1"	23 1/2"	62"	145 lbs
H2OI80HOUB	1"	1"	28"	56"	155 lbs
H2OI80HOCUB	1 1/2"	1 1/4"	28"	56"	155 lbs
H2OI115HOUB	1"	1"	28"	74"	190 lbs
H2OI115HOCUB	1 1/2"	1 1/4"	28"	74"	190 lbs
Extra High Output Units 85XHO and 115XHO					
H2OI85XHOCUB	1 1/2"	1 1/2"	28"	64"	215 lbs
H2OI115XHOCUB	1 1/2"	1 1/2"	28"	74"	240 lbs

H2O SC - Single Coil Stainless Steel Indirect Water Heaters

Item Number	Storage Capacity gal	Type	Max. First Hour Rating gal/hr @		Boiler Output Req. BTU/hr	Shp. Wgt. lbs	Trade Price
			140° F	115° F			
H2OI30UB	30	STANDARD	202	269	131,250	85	\$2,156
H2OI40UB	40	STANDARD	221	292	138,670	100	\$2,218
H2OI40LUB	42	LOWBOY	212	251	132,000	100	\$2,360
H2OI50UB	50	STANDARD	223	291	133,280	110	\$2,676
H2OI60UB	60	STANDARD	262	342	155,700	125	\$3,199
H2OI60LUB	60	LOWBOY	239	310	138,570	120	\$3,294
H2OI80UB	80	STANDARD	271	348	149,390	140	\$3,548
H2OI115UB	115	STANDARD	324	409	165,750	175	\$5,265
H2OI60HOUB	60	HIGH OUTPUT	406	541	263,600	145	\$3,453
H2OI80HOUB	80	HIGH OUTPUT	418	551	259,640	155	\$4,796
H2OI80HOCUB	80	HIGH OUTPUT COMMERICAL	442	584	227,070	155	\$5,178
H2OI115HOUB	115	HIGH OUTPUT	467	607	273,100	190	\$5,777
H2OI115HOCUB	115	HIGH OUTPUT COMMERICAL	479	623	281,300	190	\$6,869
H2OI85XHOCUB	87	EXTRA HIGH OUTPUT	738	992	495,000	215	\$6,447
H2OI115XHOCUB	115	EXTRA HIGH OUTPUT	763	1017	495,000	240	\$7,653

H2O DC Single & Dual Coil Stainless Steel Solar Water Heaters

- 60 - 115 Gallon Capacities
- 316L Stainless Steel Construction
- Top Connections (For Easy Install)
- Stainless Steel Dip Tube
- Thermoplastic Jacket
- Low Pressure Drop
- T & P Valve, Stainless Steel Aquastat Well and Drain Valve
- 2.25" EPS Insulation
- Large Diameter, Smooth Coil Heat Exchangers - Prevent Buildup
- Honeywell L4080B Aquastat



H2O

I

Indirect

60

Capacity:
 60=60 gals
 80=80 gals
 115=115 gals

D

D=Dual Coil

E

E=Electric Backup
 (3500 Watts)

UB

UB=Utica

General Information (See IOM for Complete Instructions)				
Maximum Working Pressure: 150 psi for all Capacities				
Model	Piping Connections NPT	Dimensions		
		Diameter	Height	Weight
H2O160EUB	1"	23"	62"	135 lbs
H2O180EUB	1"	28"	56"	145 lbs
H2O115EUB	1"	28"	74"	180 lbs
H2O160DUB	1"	23"	62"	165 lbs
H2O180DUB	1"	28"	56"	175 lbs
H2O115DUB	1"	28"	74"	205 lbs
H2O160DEUB	1"	23"	62"	175 lbs
H2O180DEUB	1"	28"	56"	185 lbs
H2O115DEUB	1"	28"	74"	215 lbs

H2O DC - Single & Dual Coil Stainless Steel Solar Water Heaters

Item Number	Storage Capacity gal	Type	Recovery Rate gal/hr		Ship Wgt. lbs	Trade Price
			Top Coil	Bottom Coil		
H2OI60EUB	60	ELECTRIC BACK-UP	N/A	214	135	\$4,494
H2OI80EUB	80	ELECTRIC BACK-UP	N/A	214	145	\$5,024
H2OI115EUB	115	ELECTRIC BACK-UP	N/A	214	180	\$6,967
H2OI60DUB	60	INDIRECT	185	214	165	\$4,246
H2OI80DUB	80	INDIRECT	180	214	175	\$4,835
H2OI115DUB	115	INDIRECT	190	214	205	\$6,193
H2OI60DEUB	60	ELECTRIC BACK-UP	185	214	175	\$5,244
H2OI80DEUB	80	ELECTRIC BACK-UP	180	214	185	\$5,925
H2OI115DEUB	115	ELECTRIC BACK-UP	190	214	215	\$7,433

H2O BT Stainless Steel Buffer Tanks, w/ and w/o Coil

- 22 - 115 Gallon Capacities
- 316L Stainless Steel Construction
- Top Connections (For Easy Installation)
- Thermoplastic Jacket
- Low Pressure Drop
- T & P Valve, Stainless Steel Aquastat Well and Drain Valve
- 2.25" EPS Insulation



H2O

BT
 BT=Buffer Tank

40
 Capacity:
 22=22 gals
 40=40 gals
 60=60 gals
 80=80 gals

114
 Connection:
 114=1 1/4" NPT
 112=1 1/2" NPT
 2=2" NPT

WC
 WC=With Coil

UB
 UB=Utica

General Information (See IOM for Complete Instructions)				
Maximum Working Pressure: 150 psi for all Capacities				
Model	Piping Connections NPT	Dimensions		
		Diameter	Height	Weight
H2OBT22114UB	1 1/4"	22 1/2"	24 1/2"	35 lbs
H2OBT40114UB	1 1/4"	22 1/2"	42"	87 lbs
H2OBT40112UB	1 1/2"	22 1/2"	42"	87 lbs
H2OBT402UB	2"	22 1/2"	42"	87 lbs
H2OBT60114UB	1 1/4"	26 1/2"	44"	115 lbs
H2OBT60112UB	1 1/2"	26 1/2"	44"	115 lbs
H2OBT602UB	2"	26 1/2"	44"	115 lbs
H2OBT80114UB	1 1/4"	26 1/2"	54"	125 lbs
H2OBT80112UB	1 1/2"	26 1/2"	54"	125 lbs
H2OBT802UB	2"	26 1/2"	54"	125 lbs
H2OBT115114UB	1 1/4"	26 1/2"	72"	160 lbs
H2OBT115112UB	1 1/2"	26 1/2"	72"	160 lbs
H2OBT1152UB	2"	26 1/2"	72"	160 lbs
H2OBT40114WCUB	1 1/4"	22 1/2"	42"	97 lbs
H2OBT40112WCUB	1 1/2"	22 1/2"	42"	97 lbs
H2OBT402WCUB	2"	22 1/2"	42"	97 lbs
H2OBT60114WCUB	1 1/4"	26 1/2"	44"	125 lbs
H2OBT60112WCUB	1 1/2"	26 1/2"	44"	125 lbs
H2OBT602WCUB	2"	26 1/2"	44"	125 lbs
H2OBT80114WCUB	1 1/4"	26 1/2"	54"	135 lbs
H2OBT80112WCUB	1 1/2"	26 1/2"	54"	135 lbs
H2OBT802WCUB	2"	26 1/2"	54"	135 lbs
H2OBT115114WCUB	1 1/4"	26 1/2"	72"	170 lbs
H2OBT115112WCUB	1 1/2"	26 1/2"	72"	170 lbs
H2OBT1152WCUB	2"	26 1/2"	72"	170 lbs

H2O BT - Stainless Steel Buffer Tanks (With & Without Coil)

Item Number	Storage Capacity gal	Type	Shp. Wgt. lbs	Trade Price
H2OBT22114UB	22	HYDRONIC BUFFER TANK	35	\$1,915
H2OBT40114UB	40	HYDRONIC BUFFER TANK	87	\$3,354
H2OBT40112UB	40	HYDRONIC BUFFER TANK	87	\$3,354
H2OBT402UB	40	HYDRONIC BUFFER TANK	87	\$3,354
H2OBT60114UB	60	HYDRONIC BUFFER TANK	115	\$3,992
H2OBT60112UB	60	HYDRONIC BUFFER TANK	115	\$3,992
H2OBT602UB	60	HYDRONIC BUFFER TANK	115	\$3,992
H2OBT80114UB	80	HYDRONIC BUFFER TANK	125	\$4,409
H2OBT80112UB	80	HYDRONIC BUFFER TANK	125	\$4,409
H2OBT802UB	80	HYDRONIC BUFFER TANK	125	\$4,409
H2OBT115114UB	115	HYDRONIC BUFFER TANK	160	\$5,487
H2OBT115112UB	115	HYDRONIC BUFFER TANK	160	\$5,487
H2OBT1152UB	115	HYDRONIC BUFFER TANK	160	\$5,487
H2OBT40114WCUB	40	HYDRONIC BUFFER TANKS (WITH COIL)	97	\$4,298
H2OBT40112WCUB	40	HYDRONIC BUFFER TANKS (WITH COIL)	97	\$4,299
H2OBT402WCUB	40	HYDRONIC BUFFER TANKS (WITH COIL)	97	\$4,298
H2OBT60114WCUB	60	HYDRONIC BUFFER TANKS (WITH COIL)	125	\$5,000
H2OBT60112WCUB	60	HYDRONIC BUFFER TANKS (WITH COIL)	125	\$5,000
H2OBT602WCUB	60	HYDRONIC BUFFER TANKS (WITH COIL)	125	\$5,000
H2OBT80114WCUB	80	HYDRONIC BUFFER TANKS (WITH COIL)	135	\$5,451
H2OBT80112WCUB	80	HYDRONIC BUFFER TANKS (WITH COIL)	135	\$5,451
H2OBT802WCUB	80	HYDRONIC BUFFER TANKS (WITH COIL)	135	\$5,451
H2OBT115114WCUB	115	HYDRONIC BUFFER TANKS (WITH COIL)	170	\$6,637
H2OBT115112WCUB	115	HYDRONIC BUFFER TANKS (WITH COIL)	170	\$6,637
H2OBT1152WCUB	115	HYDRONIC BUFFER TANKS (WITH COIL)	170	\$6,637

H2O ST Stainless Steel Storage Tanks

- 30 - 115 Gallon Capacities
- 316L Stainless Steel Construction
- Top Connections (For Easy Installation)
- Stainless Steel Dip Tube -Thermoplastic Jacket
- Low Pressure Drop
- T & P Valve, Stainless Steel Aquastat Well and Drain Valve
- 2.25” EPS Insulation
- Honeywell L4080B



H2O **ST** **30** **L** **UB**

ST=Storage Capacity: 30=30 gals, 40=40 gals, 60=60 gals, 80=80 gals, 115=115 gals Type: L=Lowboy, C=Commercial UB=Utica

General Information (See IOM for Complete Instructions)					
Maximum Working Pressure: 150 psi for all Capacities					
Model	Piping Connections NPT		Dimensions		
	Return/Supply	Heat Source Pressure	Diameter	Height	Weight
H2OST30UB	1"	1"	23 1/2"	34"	75 lbs
H2OST40UB	1"	1"	23 1/2"	44"	90 lbs
H2OST60UB	1"	1"	23 1/2"	62"	115 lbs
H2OST60LUB	1"	1"	23 1/2"	46"	110 lbs
H2OST80UB	1"	1"	28"	56"	140 lbs
H2OST115UB	1"	1"	28"	74"	175 lbs
H2OST80CUB	1 1/2"	1"	28"	56"	140 lbs
H2OST115CUB	1 1/2"	1"	28"	74"	175 lbs

H2O ST - Stainless Steel Storage Tanks (No Coil)				
Item Number	Storage Capacity gal	Type	Shp. Wgt. lbs	Trade Price
H2OST30UB	30	STANDARD STORAGE TANK	75	\$1,912
H2OST40UB	40	STANDARD STORAGE TANK	90	\$1,976
H2OST60UB	60	STANDARD STORAGE TANK	115	\$2,882
H2OST60LUB	60	LOWBOY STORAGE TANK	110	\$2,978
H2OST80UB	80	STANDARD STORAGE TANK	140	\$3,275
H2OST80CUB	80	COMMERCIAL STORAGE TANK	175	\$4,719
H2OST115UB	115	STANDARD STORAGE TANK	140	\$3,604
H2OST115CUB	115	COMMERCIAL STORAGE TANK	175	\$5,047

TERMS & CONDITIONS OF SALE - GENERAL TERMS

PRICES & SPECIFICATIONS: All pricing and specifications subject to change without notice. The prices herein supersede all prior quotations.

ORDERS: Orders will be accepted based on prices in effect at the time the order is received. No order or contract will become an obligation on our part until accepted by the General Sales Department. ECR International shall not be liable for any delay or failure in the delivery or shipment of goods due to any cause or causes beyond its control.

TAXES: Add to the prices and terms quoted any manufacturers' or sales tax payable on the transaction under any effective statute.

SHIPMENTS

TRUCKLOADS: \$60,000 Net Order Value - Freight Prepaid. Indirect Water Heaters and Commercial Boiler lines can be added to any residential order for freight purposes. Authorized Distributors can combine Argo, Airco, Dunkirk, EMI, Olsen, Pennco, Utica Boilers and Utica Heating on one purchase order to earn free freight.

Stop off charges of \$200 will apply to stop off locations within 100 miles of the final destination. Please call for pricing for stop off special handling for a location further than 100 miles or for special handling pricing for services such as lift gate, unloading assistance, etc.

LESS THAN TRUCKLOAD SHIPMENT: F.O.B. ECR INTERNATIONAL - FACTORY OR WAREHOUSE

See Shipping and Delivery Policy for full details.

SALES ORDER INFORMATION CHECK LIST

The following information must be included on equipment or parts orders to insure proper shipment & invoicing:

- | | |
|--|--|
| 1) Purchase Order Number | 7) Pricing |
| 2) Bill to Address | 8) Product Description (Model, Size, etc.) |
| 3) Ship to Address | 9) Fuel Type (Oil, Natural Gas, Propane) |
| 4) Method of Shipment (trailer load, UPS) | 10) Electrical (Operating Voltage, Cycles, Phases, etc.) |
| 5) Requested Ship Date | 11) Non-Standard Equipment (Indicate "Optional" when substituted for standard equipment at extra cost listed. Indicate added to standard equipment.) |
| 6) Special Instructions ("Carrier to call...") | 12) Kits or Parts (Orders for kits or parts must indicate equipment size and series.) |

Send orders to:

E-mail: ecrorderentry@ecrinternational.com

Fax: (315) 724-9319

Please note the following Remit to Address:

ECR International, Inc.

P.O. Box 8000 Department 039

Buffalo, NY 14267

SHIPPING AND DELIVERY POLICY

Shipping and Delivery Policy	
Order Type / Value*	Freight Charges*
All UPS, Fed, Ex, DHL, etc. Shipments	Freight & Handling Cost Apply
\$0.00 - \$5,000	Freight & Handling Cost Apply
\$5,001 - \$15,000	\$350
\$15,001 - \$59,999	\$300
\$60,000**	FFA

*The above freight terms apply to single purchase orders or combined purchase orders from one company with one stop totaling the above reference tiers. Additional stops will incur additional charges. Pooling from multiple companies is not allowed under this freight program.

**Orders of \$60,000 or more from one company with multiple stops will incur a \$200 stop-off charge per stop after the initial stop. Each stop location must be within 100 miles of the initial stop or additional charges will apply.

Because of packaging and shipping constraints, EMI products do not qualify for this freight program unless prior approval is obtained from your Regional Sales Manager.

Except for FFA qualifying orders, the above US shipping rates apply to shipments east of the Mississippi River. If shipments are beyond that area actual freight rates will apply.

These rates apply to destinations where no special delivery requirements are needed. Additional charges will apply when special handling and delivery is incurred. Pre-shipment notification of any special shipping or handling provisions is required. Unless otherwise noted, all products will be shipped FOB Shipping Point and transfer of ownership and responsibility is assumed by the customer for all loss or damage. ECR International will not be held liable for any damage, loss or costs which occur due to shipping delay. ECR retains the right to change or alter this program without notice and without penalty.

Family bundling is encouraged; boilers, furnaces, A/C, and controls can be combined to achieve freight tiers.

If you have any questions, please contact your ECR representative or ECR Regional Manager.

U.S. DISTRIBUTOR - RETURN MATERIAL POLICY (RMA)

Prior Approval Required - All returns for exchange, credit, repair service or warranty claim must be approved by ECR International and require an RMA number prior to return of the material. A request must be completed via the online web portal. Please log on to www.ecrcustomerportal.com to complete your request for return. If you do not already have access to the customer web portal, please contact ECR International Customer Service at 1-800-325-5479 to be set-up.

Eligibility – An RMA Request must be received within 60 days from the date of invoice for returns of New & Unused product in original packaging. A restocking fee of 15% will be charged for all new and unused returns that are approved for return. Special Order Products (items not offered as standard in ECR International trade price book) are not eligible for return as new and unused product. Request for Warranty Returns must be made within the period covered by the warranty and must fall under the terms and conditions specified in the warranty.

Repair Service - Request for repair or rework of product damaged by customer is classified as Repair Service. Repair Service is billed at \$75.00 per hour for labor and net price for parts used in repair/rework. ECR International's Return Material (RM) department will evaluate the items returned for repair service. The customer will receive an estimate for the dollar amount, determined by ECR International's RM department, required to complete the repairs requested. A Purchase Order (PO) from the customer for that amount will be required before any work is performed.

RMA Expiration Parts - Once the RMA number is issued, the product must be returned within 60 days of the RMA date, or the RMA will be canceled. Products approved for return that are received after 60 days from the RMA date will not be accepted.

Shipping & Packaging - All returns must have a valid RMA number clearly displayed on the exterior of the package or the package will not be accepted. All returns of new and unused product must be in the original packaging. All returns must be shipped prepaid by the customer unless otherwise directed by ECR as indicated on the RMA Verification. Ship all approved return material to the facility indicated on the approved RMA Request by the date indicated.

Replacement Product - If replacement product is desired it must be indicated on the RMA Request. A PO# is required for the replacement shipment and must be indicated on the RMA Request. All replacement products will be invoiced at the time of shipment. ECR will pay the ground freight for all warranty replacements.

Application of Credit - Credit for returned product will be applied to the customer's account (less restocking fees for New and Unused returns) only after confirmation of receipt by ECR and inspection of the product. Issuance of a credit for a partial return of product does not relieve the customer from the obligation to remit payment for the merchandise not returned in accordance with the payment terms referenced on the customer's invoice(s). Customer will have the option to have any product that is denied for credit returned at their expense.

Returning Installed Finished Goods (Complete boilers, furnaces, A/C units etc.)

- Equipment that is already installed should be repaired not replaced. Exceptions: leaking cast iron boilers in their first year or leaking water tanks. Leaking drain valves on water tanks are replaceable, make sure the leak is not on the valve. Tanks returned with the only leak being on the valve will be denied.
- Cast iron blocks (not complete boilers) older than one year and Indirect tanks that are leaking do not require prior approval. Simply type "Leaking" into the Authorization field and it will be accepted. Complete Cast iron boilers within their first year will still require prior authorization for full boiler replacement.
- Water leaks on copper and condensing boilers are repairable and will require prior authorization for any reason for removal.
- To guarantee credit, if a situation arises where equipment does need to be replaced, **prior authorization** from ECR is required. This will ensure that ECR has visibility to the problem and has had an opportunity to correct it prior to removal. *All equipment considered for removal should first be brought to the attention of Technical Support at 1-800-253-7900.*
- If approved, an authorization number will be given that will need to be entered in the RMA on the Customer Portal.
- For equipment that is removed from service without prior authorization by ECR, contact Customer Service. They will evaluate the circumstance and can issue a conditional RMA. The equipment will be tested in our lab to determine if removal was warranted and if credit will be given.

RMA Expiration Equipment - Once the RMA number is issued, the product must be returned within 30 days of the RMA date, or the RMA will be canceled. Products approved for return that are received after 30 days from the RMA date will not be accepted.

**This page is intentionally left blank,
products continue on the following page.**

**This page is intentionally left blank,
products continue on the following page.**

**This page is intentionally left blank,
products continue on the following page.**



There are some things you can always depend on...

www.utica boilers.com



2201 Dwyer Avenue, Utica, NY 13501
Tel. 800 325 5479
www.ecrinternational.com

All specifications subject to change without notice.
©2023 ECR International, Inc.
PN 240005093 REV. V [08/15/2023]