



## US Trade Price Book - 2021

*Effective 8/9/21*



*There are some things you can always depend on...*



[www.cticaboilers.com](http://www.cticaboilers.com)



**ECR** international

Manufactured by:  
ECR International Inc.  
2201 Dwyer Avenue, Utica, NY 13501  
Tel. 800 325 5479  
[www.ecrinternational.com](http://www.ecrinternational.com)  
PN 240005093 REV. O [07/21/2021]

## CUSTOMER SUPPORT TEAM

---

### CUSTOMER SERVICE:

Phone: (800) 325-5479 option #2  
Fax: (315) 724-9319  
Email Purchase Orders: [ecrorderentry@ecrinternational.com](mailto:ecrorderentry@ecrinternational.com)  
Email Inquiries: [customerservice@ecrinternational.com](mailto:customerservice@ecrinternational.com)

### TECHNICAL SUPPORT:

Phone: (800) 253-7900  
Fax: (866) 432-7329  
Email: [technical.support@ecrinternational.com](mailto:technical.support@ecrinternational.com)

### MARKETING SUPPORT:

Phone: (800) 325-5479  
Fax: (315) 733-1759  
E-mail: [marketing@ecrinternational.com](mailto:marketing@ecrinternational.com)

### **WWW.ECRCUSTOMERPORTAL.COM**

#### Your On-line Access to:

- Order Status
- Invoices
- Statements
- RMA
- Serial Number Look-Up
- Literature

## Table of Contents

<b><u>Condensing Natural / LP Boilers with [AI] Control (Gas Adaptive)</u></b>		<b><u>4-7</u></b>
<b>MAC/MAH</b>	Stainless Steel Wall Hung Combi & Heating Boilers (93.5-205 MBH)	<b>4</b>
<b>MACF/MAHF</b>	Stainless Steel Floor Standing Combi & Heating Boilers (125-205 MBH)	<b>6</b>
<b><u>Condensing Natural / LP Boilers</u></b>		<b><u>8-15</u></b>
<b>UB90</b>	Cast-Aluminum Floor Standing Heating Boilers (50-100 MBH)	<b>8</b>
<b>SSC</b>	Stainless Steel Wall Hung Heating Boilers (50-200 MBH)	<b>10</b>
<b>UCS 240</b>	Stainless Steel Wall Hung Heating Boilers (241 MBH)	<b>12</b>
<b>UCS 380</b>	Stainless Steel Floor Standing Heating Boilers (379 MBH)	<b>14</b>
<b><u>Controls &amp; Venting</u></b>		<b><u>16-19</u></b>
<b>MBC</b>	Multiple Boiler Control (MBC) On/Off	<b>16</b>
<b>WI-FIT-STAT</b>	Argo Wi-Fi Thermostat	<b>16</b>
<b>VENTING</b>	Coaxial, Twin Pipe & CPVC Venting for Condensing Boilers	<b>17</b>
<b><u>Natural / LP Boilers</u></b>		<b><u>20-35</u></b>
<b>CUB</b>	Copper Wall Hung Combi & Heating Boilers (100-150 MBH)	<b>20</b>
<b>SVB</b>	Cast-Iron Induced Draft Chimney/Sidewall Vented Boilers (42.5-187.5 MBH)	<b>22</b>
<b>MGB-K</b>	Cast-Iron Chimney Vented Boilers (50-299 MBH)	<b>26</b>
<b>MGC</b>	Cast-Iron Chimney Vented Boilers (50-299 MBH)	<b>26</b>
<b>PEG-E</b>	Cast-Iron Steam Boilers (75-299 MBH)	<b>30</b>
<b>JE COMMERCIAL</b>	Cast-Iron Commercial Steam Boilers (300-1,500 MBH)	<b>32</b>
<b><u>Oil Boilers</u></b>		<b><u>36-47</u></b>
<b>TRIFIRE TRB</b>	Cast-Iron 3-Pass Boilers (105-231 MBH)	<b>36</b>
<b>DHW MODULE</b>	Domestic Hot Water Module	<b>36</b>
<b>STARFIRE SFH</b>	Cast-Iron Chimney Vented Boilers (119-259 MBH)	<b>40</b>
<b>SBO</b>	Cast-Iron Steam Boilers (119-210 MBH)	<b>44</b>
<b><u>Indirect Tanks</u></b>		<b><u>46-55</u></b>
<b>H2O GL</b>	Single Coil Glass Lined Indirect Water Heaters (31-106 GALS)	<b>46</b>
<b>H2O SC</b>	Single Coil Stainless Steel Indirect Water Heaters (30-115 GALS)	<b>48</b>
<b>H2O DC</b>	Single & Dual Coil Stainless Steel Solar Water Heaters (60-115 GALS)	<b>50</b>
<b>H2O BT</b>	Stainless Steel Buffer Tanks with and without Coil (22-115 GALS)	<b>52</b>
<b>H2O ST</b>	Stainless Steel Storage Tanks (30-115 GALS)	<b>54</b>
<b><u>Terms, Shipping &amp; Delivery Policy, RMA Policy</u></b>		<b><u>56-58</u></b>

## MAC/MAH Stainless Steel Wall Hung Combi & Heating Boilers

- MBH Input 93.5 - 164 (CH) / 115.5 - 205 (DHW)
- 95% AFUE  
ENERGY STAR® Certified
- [AI] Control Technology Recognizes Natural or LP Gas  
No field conversion kit required.
- 6.9:1 Turndown Modulation Ratio in DHW Mode(115)  
7:1 Turndown Modulation Ratio in DHW Mode (150/205)  
5.6:1 Turndown Modulation Ratio in CH Mode (100/115)  
5.7:1 Turndown Modulation Ratio in CH Mode (125/150)  
5.5:1 Turndown Modulation Ratio in CH Mode (165/205)
- 2.5 gpm DHW @ 70°F Rise (115)  
3.5 gpm DHW @ 70°F Rise (150)  
5 gpm DHW @ 70°F Rise (205)
- LABOR SAVER™ Primary/Secondary Manifold Included
- Low Water Pressure Switch
- Wall Hung or Floor Stand Kit Available



General Information (See IOM for Complete Instructions)							
Model	MAH-100	MAH-125	MAC-115	MAC-150	MAH-165	MAC-205	
System Supply/Return	G 3/4" Straight Thread				G 1" Straight Thread		
System Supply/Return with Provided Manifold	1 1/4" Copper Sweat				1 1/2" Copper Sweat	1 1/4" Copper Sweat	
Gas Inlet	3/4" NPT				3/4" NPT		
Condensate Drain	13/16" ID Hose				3/4" NPT		
DHW Outlet (125 Optional)	G 1/2" Straight Thread				G 3/4" Straight Thread		
DHW (Cold Water) Inlet	1/2"				3/4"		
Electrical	120 Volts AC, 60 hertz, 1 phase, less than 12 amps (15 amp circuit recommended)						
Water Content (Gallons)	1				1 1/4		
Dimensions	A-Height	30"				30"	
	B-Width	17 3/4"				17 3/4"	
	C-Depth	13 9/16"				21 1/2"	

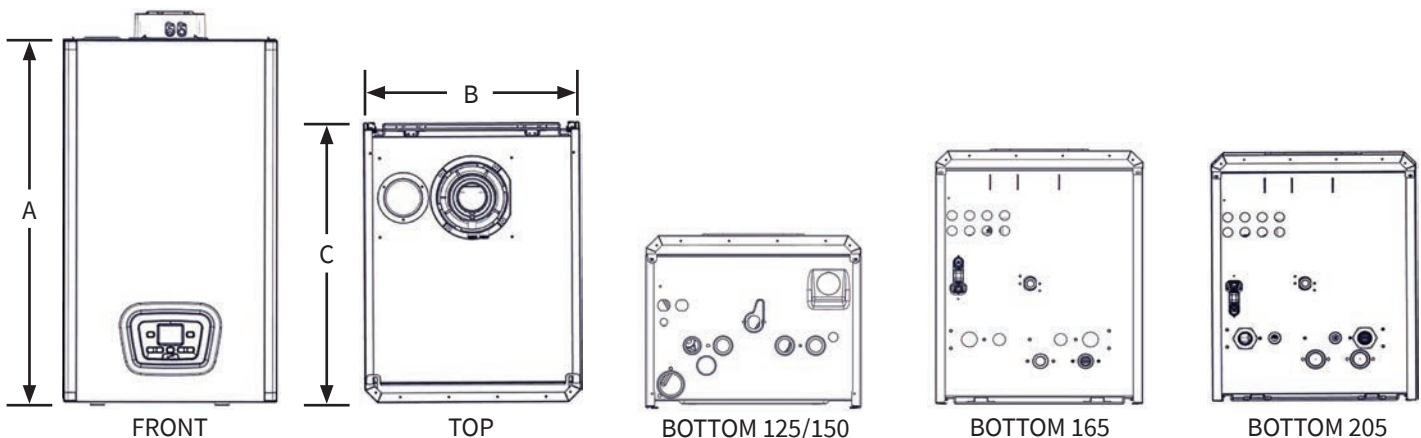

MAC/MAH - Stainless Steel Wall Hung Combi & Heating Boilers										
Model	Item Number	Type	Input MBH CH	Input MBH DHW	AHRI Net MBH	AFUE	Fuel	Pump	Shp. Wgt. lbs	Trade Price
MAH100	MAH110003600110	HEATING	93.5	N/A	74	95.0%	NAT/LP	LESS	94	\$2,652
MAH125	MAH112503600110	HEATING	125	N/A	98	95.0%	NAT/LP	LESS	102	\$3,239
MAH165	MAH116503600110	HEATING	164	N/A	133	95.0%	NAT/LP	LESS	125	\$3,804
MAC115	MAC111503600110	COMBI	93.5	115.5	74	95.0%	NAT/LP	LESS	103	\$2,826
MAC150	MAC115003600110	COMBI	125	153	98	95.0%	NAT/LP	LESS	103	\$3,459
MAC205	MAC120503600110	COMBI	164	205	133	95.0%	NAT/LP	LESS	125	\$4,017
MAH100	MAH110003640110	HEATING	93.5	N/A	74	95.0%	NAT/LP	TACO ECM	94	\$2,824
MAH125	MAH112503640110	HEATING	125	N/A	98	95.0%	NAT/LP	TACO ECM	102	\$3,404
MAH165	MAH116503640110	HEATING	164	N/A	133	95.0%	NAT/LP	TACO ECM	125	\$3,967
MAC115	MAC111503640110	COMBI	93.5	115.5	74	95.0%	NAT/LP	TACO ECM	103	\$2,995
MAC150	MAC115003640110	COMBI	125	153	98	95.0%	NAT/LP	TACO ECM	103	\$3,625
MAC205	MAC120503640110	COMBI	164	205	133	95.0%	NAT/LP	TACO ECM	125	\$4,179
MAH100	MAH110003620110	HEATING	93.5	N/A	74	95.0%	NAT/LP	GRUNDFOS	94	\$2,824
MAH125	MAH112503620110	HEATING	125	N/A	98	95.0%	NAT/LP	GRUNDFOS	102	\$3,404
MAH165	MAH116503620110	HEATING	164	N/A	133	95.0%	NAT/LP	GRUNDFOS	125	\$3,967
MAC115	MAC111503620110	COMBI	93.5	115.5	74	95.0%	NAT/LP	GRUNDFOS	103	\$2,995
MAC150	MAC115003620110	COMBI	125	153	98	95.0%	NAT/LP	GRUNDFOS	103	\$3,625
MAC205	MAC120503620110	COMBI	164	205	133	95.0%	NAT/LP	GRUNDFOS	125	\$4,179

MAC/MAH (Use Parts Multiplier for All of the Following)			
Model	Item Number	Description	Trade Price
MAC(H)	BD710487302V	OUTSIDE AIR SENSOR	\$39
MAC(H)	550003189	DHW SENSOR KIT	\$84
MAC(H)	240010266	FLOOR STAND KIT	\$700
MAC(H)	550003212	HEAT EXCHANGER CLEANING KIT	\$59

## MACF/MAHF Stainless Steel Floor Standing Combi & Heating Boilers

- MBH Input 93.5 - 164 (CH) / 115.5 - 205 (DHW)
- 95% AFUE  
ENERGY STAR® Certified
- [AI] Control Technology Recognizes Natural or LP Gas  
No field conversion kit required.
- 6.9:1 Turndown Modulation Ratio in DHW Mode (115)  
7:1 Turndown Modulation Ratio in DHW Mode (150/205)  
5.6:1 Turndown Modulation Ratio in CH Mode (100/115)  
5.7:1 Turndown Modulation Ratio in CH Mode (125/150)  
5.5:1 Turndown Modulation Ratio in CH Mode (165/205)
- 2.5 gpm DHW @ 70°F Rise (115)  
3.5 gpm DHW @ 70°F Rise (150)  
5.0 gpm DHW @ 70°F Rise (205)
- LABOR SAVER™ Primary/Secondary Manifold Built-In
- Low Water Pressure Switch
- Compact, Floor Standing Design



General Information (See IOM for Complete Instructions)				
Model	MAHF-100/125	MACF-115/150	MAHF-165	MACF-205
Water Return/Supply	1 1/4" Copper	1 1/4" Copper	1 1/2" Copper	1 1/2" Copper
Gas	3/4" NPT	3/4" NPT	3/4" NPT	3/4" NPT
Condensate Drain	3/4" NPT	3/4" NPT	3/4" NPT	3/4" NPT
DHW Outlet (125 Optional)	3/4" SWT	1/2" SWT	NA	3/4" SWT
DHW (Cold Water) Inlet	NA	1/2" SWT	NA	3/4" SWT
Electrical	120 Volts AC, 60 hertz, 1 phase, less than 12 amps (15 amp circuit recommended)			
Water Content (Gallons)	1	1	1.25	1.25
Dimensions	A-Height	43.65"	43.65"	43.65"
	B-Width	24.7"	24.7"	24.7"
	C-Depth	17.46"	17.46"	23.55"

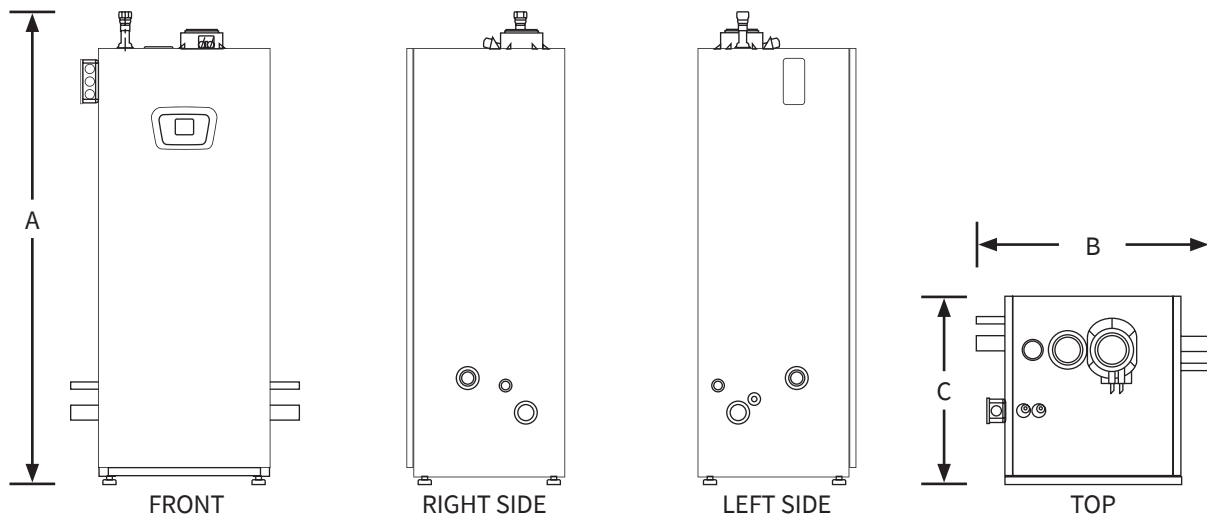

**MACF/MAHF - Stainless Steel Floor Standing Combi & Heating Boilers**

Model	Item Number	Type	Input MBH CH	Input MBH DHW	AHRI Net MBH	AFUE	Fuel	Pump	Shp. Wgt. lbs	Trade Price
MAHF100	MAH110005600110	HEATING	93.5	N/A	74	95.0%	NAT/LP	LESS	148	\$2,970
MAHF125	MAH112505600110	HEATING	125	N/A	98	95.0%	NAT/LP	LESS	148	\$3,613
MAHF165	MAH116505600110	HEATING	164	N/A	98	95.0%	NAT/LP	LESS	158	\$4,374
MACF115	MAC111505600110	COMBI	93.5	115.5	74	95.0%	NAT/LP	LESS	148	\$3,212
MACF150	MAC115005600110	COMBI	125	153	98	95.0%	NAT/LP	LESS	148	\$3,858
MACF205	MAC120505600110	COMBI	164	205	133	95.0%	NAT/LP	LESS	168	\$4,619
MAHF100	MAH110005640110	HEATING	93.5	N/A	74	95.0%	NAT/LP	TACO ECM	148	\$3,135
MAHF125	MAH112505640110	HEATING	125	N/A	98	95.0%	NAT/LP	TACO ECM	148	\$3,781
MAHF165	MAH116505640110	HEATING	164	N/A	98	95.0%	NAT/LP	TACO ECM	158	\$4,561
MACF115	MAC111505640110	COMBI	93.5	115.5	74	95.0%	NAT/LP	TACO ECM	148	\$3,377
MACF150	MAC115005640110	COMBI	125	153	98	95.0%	NAT/LP	TACO ECM	148	\$4,027
MACF205	MAC120505640110	COMBI	164	205	133	95.0%	NAT/LP	TACO ECM	168	\$4,806
MAHF100	MAH110005620110	HEATING	93.5	N/A	74	95.0%	NAT/LP	GRUNDFOS	148	\$3,135
MAHF125	MAH112505620110	HEATING	125	N/A	98	95.0%	NAT/LP	GRUNDFOS	148	\$3,781
MAHF165	MAH116505620110	HEATING	164	N/A	98	95.0%	NAT/LP	GRUNDFOS	158	\$4,561
MACF115	MAC111505620110	COMBI	93.5	115.5	74	95.0%	NAT/LP	GRUNDFOS	148	\$3,377
MACF150	MAC115005620110	COMBI	125	153	98	95.0%	NAT/LP	GRUNDFOS	148	\$4,027
MACF205	MAC120505620110	COMBI	164	205	133	95.0%	NAT/LP	GRUNDFOS	168	\$4,806

**MACF/MAHF (Use Parts Multiplier for All of the Following)**

Model	Item Number	Description	Trade Price
MAC(H)F	BD710487302V	OUTSIDE AIR SENSOR	\$39
MAC(H)F	550003189	DHW SENSOR KIT	\$84
MAC(H)F	550003212	HEAT EXCHANGER CLEANING KIT	\$59

## UB90 Cast-Aluminum Floor Standing Heating Boilers

- MBH Input 50 - 100 (CH)
- 90% AFUE  
ENERGY STAR® Certified
- Natural or LP Gas
- High Efficiency Cast Aluminum Heat Exchanger
- Fuel Smart Hydrostat Control: Temperature Limit
- Low Water Cut Off (LWCO)
- Boiler Reset
- Compact Design, Floor Standing Design
- Stainless Steel Premix Burner
- Sealed Combustion
- Induced Draft Blower with Adjustable Exhaust



General Information (See IOM for Complete Instructions)			
Model	UB90-50	UB90-75	UB90-100
Water Return/Supply	1 1/4" NPT		
Gas	1/2" NPT		
Condensate Drain	1/2" CPVC Stub		
Electrical	120 Volts AC, 60 hertz, 1 phase, less than 12 amps (15 amp circuit recommended)		
Water Content (Gallons)	2.6		
Dimensions	Height	36 1/4"	
	Width	17 3/4"	
	Depth	17 3/8"	

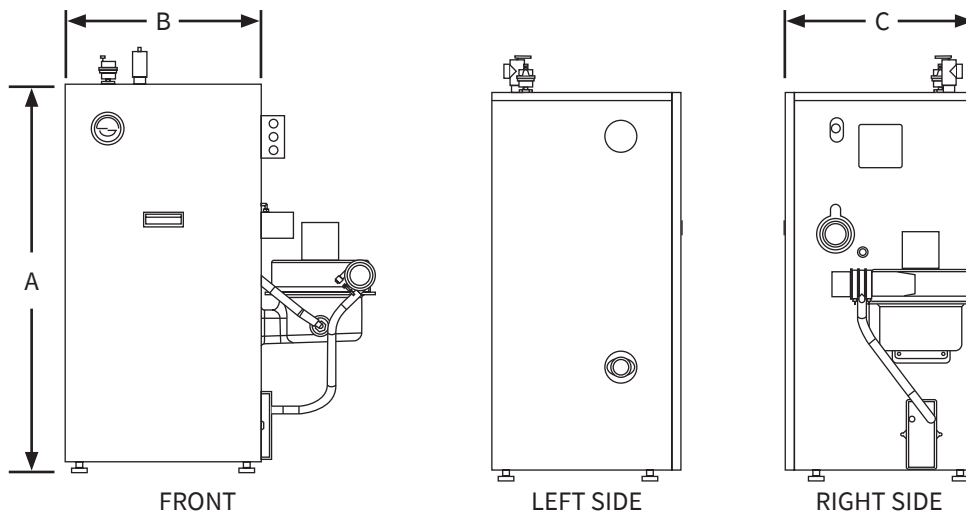



**UB90 - Cast-Aluminum Floor Standing Heating Boilers**

Model	Item Number	Input MBH	AHRI Net MBH	AFUE	Fuel	Pump	Shp. Wgt. lbs	Trade Price
UB90-50	U90205003200410	50	39	90.0%	NAT	LESS	220	\$3,811
UB90-75	U90207503200410	75	59	90.0%	NAT	LESS	220	\$3,811
UB90-100	U90210003200410	100	78	90.0%	NAT	LESS	220	\$3,811
UB90-50	U90205003240410	50	39	90.0%	NAT	TACO ECM	220	\$3,889
UB90-75	U90207503240410	75	59	90.0%	NAT	TACO ECM	220	\$3,889
UB90-100	U90210003240410	100	78	90.0%	NAT	TACO ECM	220	\$3,889
UB90-50	U90205003220410	50	39	90.0%	NAT	GRUNDFOS	220	\$3,889
UB90-75	U90207503220410	75	59	90.0%	NAT	GRUNDFOS	220	\$3,889
UB90-100	U90210003220410	100	78	90.0%	NAT	GRUNDFOS	220	\$3,889

**UB90 - LP**

UB90-50	U90205013200410	50	39	90.0%	LP	LESS	220	\$3,811
UB90-75	U90207513200410	75	59	90.0%	LP	LESS	220	\$3,811
UB90-100	U90210013200410	100	78	90.0%	LP	LESS	220	\$3,811
UB90-50	U90205013240410	50	39	90.0%	LP	TACO ECM	220	\$3,889
UB90-75	U90207513240410	75	59	90.0%	LP	TACO ECM	220	\$3,889
UB90-100	U90210013240410	100	78	90.0%	LP	TACO ECM	220	\$3,889
UB90-50	U90205013220410	50	39	90.0%	LP	GRUNDFOS	220	\$3,889
UB90-75	U90207513220410	75	59	90.0%	LP	GRUNDFOS	220	\$3,889
UB90-100	U90210013220410	100	78	90.0%	LP	GRUNDFOS	220	\$3,889

**UB90 (Use Parts Multiplier for All of the Following)**

Model	Item Number	Description	Trade Price
UB90	29571	CONCENTRIC VENT KIT 3"	\$260
UB90	29570	CONCENTRIC VENT KIT 2"	\$260
UB90-50	550002631	CONVERSION KIT NAT. TO LP UB90-50 (Series IV) 0' - 10,000'	\$90
UB90-75	550002629	CONVERSION KIT NAT. TO LP UB90-75 (Series IV) 5,000' - 10,000'	\$90
UB90-75	550002630	CONVERSION KIT NAT. TO LP UB90-75 (Series IV) 0' - 5,000'	\$90
UB90-100	550002700	CONVERSION KIT NAT. TO LP UB90-100 (Series IV) 0' - 10,000'	\$90
UB90-50	550002635	CONVERSION KIT LP TO NAT. UB90-50 (Series IV) 0' - 10,000'	\$90
UB90-75	550002634	CONVERSION KIT LP TO NAT. UB90-75 (Series IV) 0' - 10,000'	\$90
UB90-100	550002701	CONVERSION KIT LP TO NAT. UB90-100 (Series IV) 0' - 10,000'	\$90
UB90	14624002	FILL-TROL #110 FOR WATER BOILERS 150 MBH OR LESS	\$347

## SSC Stainless Steel Wall Hung Heating Boilers

- MBH Input 50 - 200 (CH)
- 95% AFUE  
ENERGY STAR® Certified
- Patented High-grade 316L/444 Stainless Steel Fin Coil Heat Exchanger  
Patent No. 10,012,413
- User Display Interface: Easy Programming with Text Display
- Built-In Primary/Secondary Piping
- Built-In Low Water Cut Off
- 5:1 Turndown Ratio
- Low Maintenance, Self-Cleaning Vertical Heat Exchanger
- Wall mounted, Bracket Included



General Information (See IOM for Complete Instructions)					
Model	UBSSC-050	UBSSC-075	UBSSC-100	UBSSC-150	UBSSC-200
Water Return/Supply	1 1/4" NPT			1 1/4" NPT	
Gas	1/2" NPT			3/4" NPT	
Condensate Drain	3/4" NPT			3/4" NPT	
Electrical	120 Volts AC, 60 hertz, 1 phase, less than 12 amps (15 amp circuit recommended)				
Water Content (Gallons)	1.1			1.8	
Dimensions	A-Height	31"			42"
	B-Width	20"			23"
	C-Depth	14 3/4"			16"

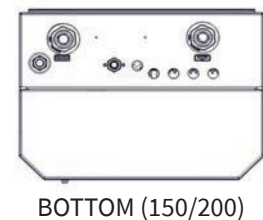
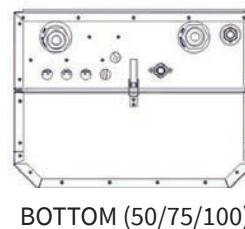
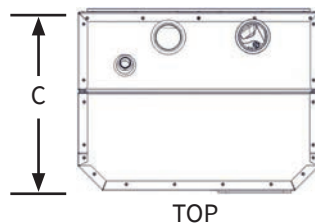
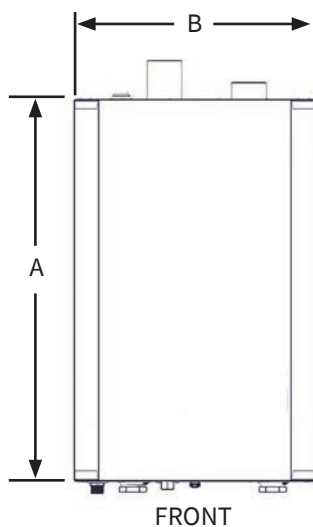

SSC - Stainless Steel Wall Hung Heating Boilers								
Model	Item Number	Input MBH	AHRI Net MBH	AFUE	Fuel	Pump	Shp. Wgt. lbs	Trade Price
UBSSC-50	SSC105003500210	50	40	95.0%	NAT	LESS	111	\$4,628
UBSSC-75	SSC107503500210	75	60	95.0%	NAT	LESS	111	\$4,719
UBSSC-100	SSC110003500210	100	79	95.0%	NAT	LESS	111	\$4,936
UBSSC-150	SSC115003500210	150	121	95.0%	NAT	LESS	182	\$6,231
UBSSC-200	SSC120003500210	200	161	95.0%	NAT	LESS	182	\$6,656
UBSSC-50	SSC105003540210	50	40	95.0%	NAT	TACO ECM	111	\$4,790
UBSSC-75	SSC107503540210	75	60	95.0%	NAT	TACO ECM	111	\$4,881
UBSSC-100	SSC110003540210	100	79	95.0%	NAT	TACO ECM	111	\$5,099
UBSSC-150	SSC115003540210	150	121	95.0%	NAT	TACO ECM	182	\$6,394
UBSSC-200	SSC120003540210	200	161	95.0%	NAT	TACO ECM	182	\$6,816
UBSSC-50	SSC105003520210	50	40	95.0%	NAT	GRUNDFOS	111	\$4,790
UBSSC-75	SSC107503520210	75	60	95.0%	NAT	GRUNDFOS	111	\$4,881
UBSSC-100	SSC110003520210	100	79	95.0%	NAT	GRUNDFOS	111	\$5,099
UBSSC-150	SSC115003520210	150	121	95.0%	NAT	GRUNDFOS	182	\$6,394
UBSSC-200	SSC120003520210	200	161	95.0%	NAT	GRUNDFOS	182	\$6,816
SSC - High Altitude								
UBSSC-50	SSC105003542210	50*	40*	95.0%	NAT	TACO ECM	111	\$4,790
UBSSC-75	SSC107503542210	75*	60*	95.0%	NAT	TACO ECM	111	\$4,881
UBSSC-100	SSC110003542210	100*	79*	95.0%	NAT	TACO ECM	111	\$5,099
UBSSC-150	SSC115003542210	150*	121*	95.0%	NAT	TACO ECM	182	\$6,394
UBSSC-200	SSC120003542210	200*	161*	95.0%	NAT	TACO ECM	182	\$6,816

\* High Altitude – Capacity Reduces with Elevation. Refer to IOM for Actual Capacity Ratings.

SSC (Use Parts Multiplier for All of the Following)			
Model	Item Number	Description	Trade Price
UBSSC-50	550002303	050 NATURAL TO LP AND LP TO NATURAL GAS CONVERSION KIT	\$55
UBSSC-75	550002304	075 NATURAL TO LP AND LP TO NATURAL GAS CONVERSION KIT	\$55
UBSSC-100	550002305	100 NATURAL TO LP AND LP TO NATURAL GAS CONVERSION KIT	\$55
UBSSC-150	550002306	150 NATURAL TO LP AND LP TO NATURAL GAS CONVERSION KIT	\$55
UBSSC-200	550002307	200 NATURAL TO LP AND LP TO NATURAL GAS CONVERSION KIT	\$55
SSC SERIES	29570	2" CONCENTRIC VENT KIT	\$260
SSC SERIES	29571	3" CONCENTRIC VENT KIT	\$260
SSC SERIES	550002186	MULTIPLE BOILER SENSOR KIT	\$93
SSC SERIES	240010266	FLOOR STAND KIT	\$700
SSC SERIES	550003748	CSD-1 KIT	\$477

## UCS-240 Stainless Steel Wall Hung Heating Boilers

- MBH Input 241 (CH)
- 95% AFUE  
ENERGY STAR® Certified
- LABOR SAVER™ Manifold Included
- 6.7:1 Modulation Turndown Ratio
- Wall Hung or Floor Base Kit Available
- Anti-Wind Function: Control automatically adjusts the fan speed to prevent loss of flame and lockouts
- Flame Stabilization: Control allows the flame to stabilize before modulating, preventing flame drop outs and recycling
- Optional Plug-and-Play, CSD-1 Kit Available



General Information (See IOM for Complete Instructions)		
Model	UCS-240	
Water Return/Supply	1"	
Gas	3/4" NPT	
Condensate Drain	3/4" NPT	
Electrical	120 Volts AC, 60 hertz, 1 phase, less than 12 amps (15 amp circuit recommended)	
Water Content (Gallons)	.8	
Dimensions	A-Height	31 1/16"
	B-Width	17 3/4"
	C-Depth	23"

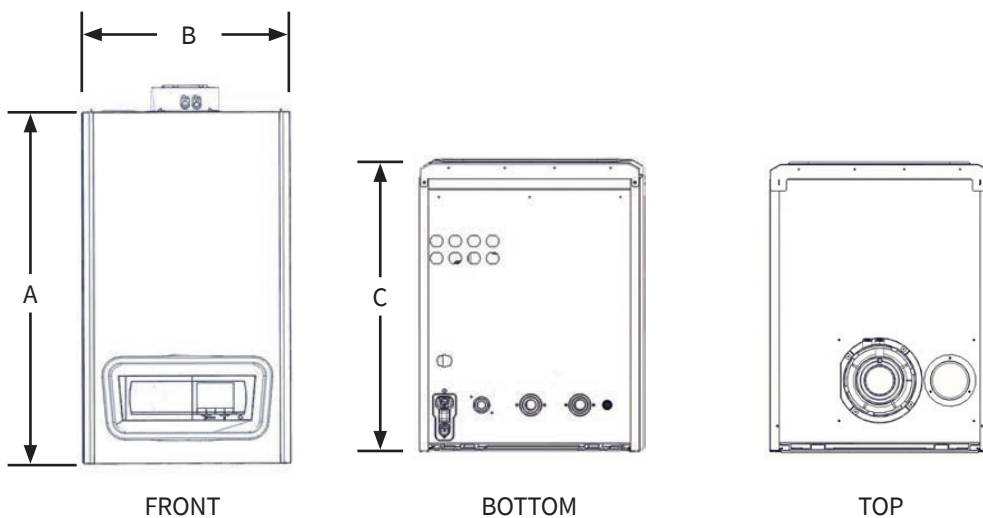

**UCS-240 - Stainless Steel Wall Hung Heating Boilers**

Model	Item Number	Input MBH	AHRI Net MBH	AFUE	Fuel	Pump	Shp. Wgt. lbs	Trade Price
UCS-240	UCS124000600110	241	216	95.0%	NAT	LESS	145	\$6,717

**UCS-240 (Use Parts Multiplier for All of the Following)**

Model	Item Number	Description	Trade Price
UCS-240	550003322	MANUAL RESET HIGH LIMIT KIT L4006E1109	\$275
UCS-240	550003323	MANUAL RESET LWCO KIT	\$264
UCS-240	550003332	CSD-1 KIT (INCLUDES HIGH LIMIT AND MANUAL RESET LWCO)	\$539
UCS-240	550003354	COMMON VENTING CHECK VALVE KIT	\$386
UCS-240	550003316	LP CONVERSION KIT	\$176
UCS-240	BD710487302V	OUTDOOR AIR SENSOR	\$39
UCS-240	550003189	DHW SENSOR KIT	\$84
UCS-240	550003304	FLOOR BASE KIT	\$544

## UCS-380 Stainless Steel Floor Standing Heating Boilers

- MBH Input 379
- 95% Thermal Efficiency
- LABOR SAVER™ Manifold Included
- 10.5:1 Modulation Turndown Ratio
- Compact, Floor Standing Design
- Anti-Wind Function: Control automatically adjusts the fan speed to prevent loss of flame and lockouts
- Flame Stabilization: Control allows the flame to stabilize before modulating, preventing flame drop outs and recycling
- Optional Plug-and-Play, CSD-1 Kit Available



General Information (See IOM for Complete Instructions)		
Model	UCS-380	
Water Return/Supply	1 1/2"	
Gas	1" NPT	
Condensate Drain	3/4" NPT	
Electrical	120 Volts AC, 60 hertz, 1 phase, less than 12 amps (15 amp circuit recommended)	
Water Content (Gallons)	4.6	
Dimensions	A-Height	50"
	B-Width	23 5/8"
	C-Depth	25 1/2"

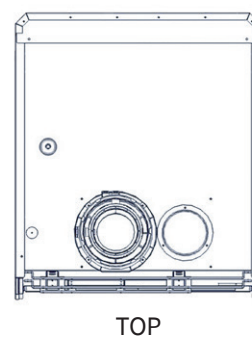
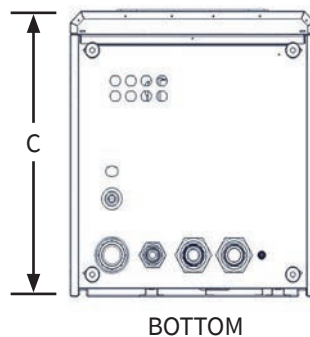
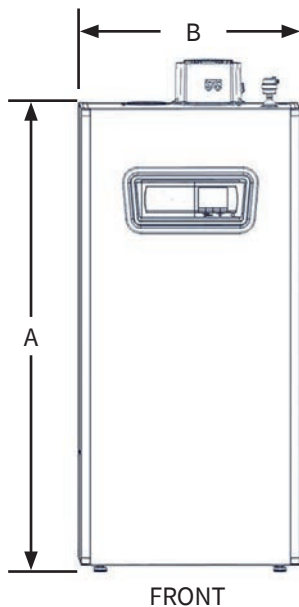

**UCS-380 - Stainless Steel Floor Standing Heating Boilers**

Model	Item Number	Input MBH	AHRI Net MBH	Therm. Eff.	Fuel	Pump	Shp. Wgt. lbs	Trade Price
UCS-380	UCS138000600110	379	303	95.0%	NAT	LESS	255	\$10,563

**UCS-380 (Use Parts Multiplier for All of the Following)**

Model	Item Number	Description	Trade Price
UCS-380	550003322	MANUAL RESET HIGH LIMIT KIT L4006E1109	\$275
UCS-380	550003323	MANUAL RESET LWCO KIT	\$264
UCS-380	550003332	CSD-1 KIT (INCLUDES HIGH LIMIT AND MANUAL RESET LWCO)	\$539
UCS-380	550003354	COMMON VENTING CHECK VALVE KIT	\$386
UCS-380	550003317	LP CONVERSION KIT	\$176
UCS-380	BD710487302V	OUTDOOR AIR SENSOR	\$39
UCS-380	550003189	DHW SENSOR KIT	\$84



## MBC Multiple Boiler Control

- Operation of up to Four Boilers
- LCD Display
- Push Buttons for Navigating Settings
- Warm Weather Shutdown (WWSD)
- Set Back Scheduling
- Boiler Stage Delay
- Boiler Rotation
- Combustion or Alarm Control Relay
- Flow or Combustion Air Proof Delay
- Energy Management System Compatible (0-10 or 2-10 Vdc)
- Sensors Included:
  - (1) Outdoor Sensor
  - (2) Water Temperature Sensors



MBC - Staging Control			
Model	Item Number	Description	Trade Price
AMB4B	AMB4BUB	MULTIPLE BOILER CONTROL (MBC)	\$1,377
Additional Accessories			
AMB4B	240012663	WATER TEMPERATURE SENSOR	\$103
AMB4B	240012664	OUTDOOR SENSOR	\$103



## ARGO Wi-Fi Thermostat

- Remote access and monitoring
- Improved serviceability. Having your installer connected provides better service
- Enjoy comfort, energy savings and lower utility bills
- Connect to compatible Utica Boilers for additional benefits and monitoring capabilities
- Connect to multiple smartphones
- Control multiple thermostats from a single smartphone or tablet
- Switch between manual and schedule modes
- Ability to lock thermostat settings
- Display Setting can be set to Fahrenheit (°F) or Celsius (°C)



















Wi-Fi Thermostats			
Model	Item Number	Description	Trade Price
ARGO	550003641UB	ARGO WI-FI THERMOSTAT	\$365









# VENTING

Twin Pipe Polypropylene Venting (Use Parts Multiplier for All of the Following)							Image	Item Number	Description	Trade Price
125/150	165/205	UB90	SSC/SSV	UCS 240	UCS 380					
X							KHG714059113	TO CONVERT FROM CONCENTRIC TO 3" TWIN PIPE	\$18	
X	X			X			550003416	3" (80mm)VENTING CLAMP SINGLE WALL	\$39	
X	X			X			550003452	3" (80mm)CLAMSHELL CLAMP (5PK)	\$38	
X	X			X			KUG714132010	3" (80mm)HORIZONTAL VENT TERM	\$21	
X	X			X			KUG714132110	3" (80mm)VERTICAL VENT TERM	\$50	
X	X			X			550003734	3" (80mm)POLYPROPYLENE 45 ELBOWS W/ CLAMP	\$15	
X	X			X			550003735	3" (80mm)POLYPROPYLENE 90 ELBOWS W/ CLAMP	\$15	
X	X			X			550003767	3" (80mm)POLYPROPYLENE PIPE 3.28' (1m) L W/ CLAMP	\$23	
	X			X			KHG714089010	TO CONVERT FROM CONCENTRIC TO 3" TWIN PIPE	\$42	
				X			550003453	4" (110mm)CLAMSHELL CLAMP (5PK)	\$50	
				X			BD7106314V	TO CONVERT FROM CONCENTRIC TO 4" TWIN PIPE	\$135	
				X			KUG714132710	4" (110mm)HORIZONTAL VENT TERM	\$130	
				X			KUG714132810	4" (110mm)VERTICAL VENT TERM	\$117	
				X			550003731	4" (110mm)POLYPROPYLENE 45 ELBOWS W/ CLAMP	\$34	
				X			550003732	4" (110mm)POLYPROPYLENE 90 ELBOWS W/ CLAMP	\$34	
				X			550003733	4" (110mm)POLYPROPYLENE PIPE 3.28' (1m) L W/ CLAMP	\$47	

## VENTING

Twin Pipe CPVC Venting (Use Parts Multiplier for All of the Following)							Image	Item Number	Description	Trade Price
125/150	165/205	UB90	SSC/SSV	UCS 240	UCS 380					
X							550003184	TWIN PIPE ADAPTER 60MM TO CPVC 3"	\$61	
	X			X			550003403	TWIN PIPE ADAPTER 80MM TO CPVC 3"	\$113	
		X					240009663	2" CPVC 90° ELBOW	\$31	
		X					240006819	2" CPVC TEE, SCHEDULE 80	\$42	
		X					240006822	2" CPVC COUPLING	\$28	

## CUB Copper Wall Hung Combi & Heating Boilers

- MBH Input 50 - 150 (CH) / 150 (DHW)
- 85% AFUE
- LABOR SAVER™ Primary/Secondary Manifold Included
- Wall Hung or Floor Base Kit Available
- Chimney or Horizontal Vent
- Advanced Controls - Digital Display with temperature indication, diagnostics and status symbols showing: Heating mode, Burner On and Burner Modulation Level
- Combi Model: Stainless Steel Brazed Plate Heat Exchanger for potable domestic hot water



Shown with optional floor base kit

General Information (See IOM for Complete Instructions)				
Model	CCB-150	CHB-150	CHB-130	CHB-100
Water Return/Supply	3/4"	3/4"	3/4"	3/4"
Gas	3/4" NPT	3/4" NPT	3/4" NPT	3/4" NPT
Condensate Drain	3/4" NPT	3/4" NPT	3/4" NPT	3/4" NPT
DHW Outlet	3/4" NPT	Indirect Tank Connection: 3/4" Capped		
DHW Inlet	3/4" NPT	Indirect Tank Connection: 3/4" Capped		
Electrical	120 Volts AC, 60 hertz, 1 phase, less than 12 amps (15 amp circuit recommended)			
Water Content (Gallons)	.396	.396	.317	.211
Dimensions	A-Height	27 9/16"	27 9/16"	27 9/16"
	B-Width	17 23/32"	17 23/32"	15 3/4"
	C-Depth	13"	13"	13"

CuB Combi Unit (CCB-150) Shown

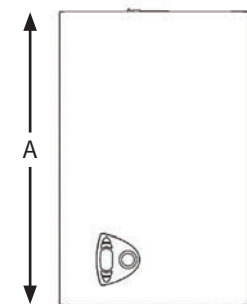

FRONT

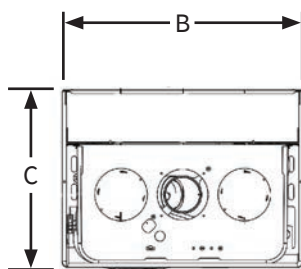

TOP

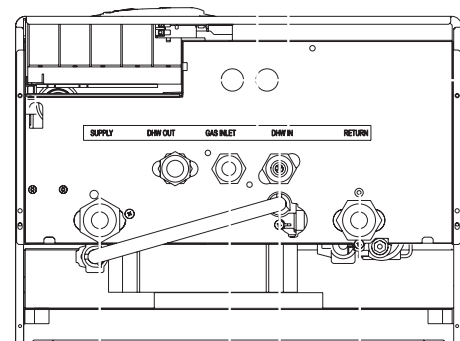

BOTTOM

<b>CUB - Copper Wall Hung Combi or Heating Boilers</b>									
<b>Model</b>	<b>Item Number</b>	<b>Type</b>	<b>Input MBH</b>	<b>AHRI Net MBH</b>	<b>AFUE</b>	<b>Fuel</b>	<b>Pump</b>	<b>Shp. Wgt. lbs</b>	<b>Trade Price</b>
CHB100	CHB0100000110	HEATING	100	73	85.0%	NAT	LESS	65	\$2,047
CHB130	CHB0130000110	HEATING	130	96	85.0%	NAT	LESS	69	\$2,268
CHB150	CHB0150000110	HEATING	150	110	85.0%	NAT	LESS	73	\$2,398
CCB150	CCB0150000110	COMBI	150	110	85.0%	NAT	LESS	78	\$2,643
<b>CUB (Use Parts Multiplier for All of the Following)</b>									
<b>Model</b>	<b>Item Number</b>	<b>Description</b>							<b>Trade Price</b>
CCB/CHB150	FE3980C150	NATURAL TO LP CONVERSION KIT (CCB150 & CHB-150)							\$80
CHB100	FE3980C300	NATURAL TO LP CONVERSION KIT (CHB100)							\$71
CHB130	FE3980B950	NATURAL TO LP CONVERSION KIT (CHB130)							\$73
CUB SERIES	5612601	DIRECT VENT KIT							\$169
CUB SERIES	FE013018X0	OUTSIDE AIR SENSOR							\$36
CUB SERIES	550002958	DHW SENSOR KIT							\$65
CUB SERIES	240010266	FLOOR STAND KIT							\$700
CHB100/130	550003450	CHB 100/130 FLOOR BASE KIT							\$386
CCB/CHB150	550003451	CCB/CHB 150 FLOOR BASE KIT							\$386

## SVB Cast Iron Induced Draft Chimney/Side Wall Vented Boilers

- MBH Input 42.5 - 187.5 (CH)
- Up to 84.4% AFUE
- Dependable Cast Iron Heat Exchanger with Cast Iron Push Nipples
- Honeywell High Limit/Electronic Ignition Control
  - Recessed under the boiler's protective jacket
  - Digital Temperature display and diagnostics
  - Plug in connection for the inducer fan
  - Plug in connection for the system pump
- Induced Draft Fan



General Information (See IOM for Complete Instructions)						
Model	SVB-2	SVB-3	SVB-4	SVB-5	SVB-6	
Water Return/Supply	1 1/4" NPT					
Gas	1/2" NPT					
Electrical	120 Volts AC, 60 hertz, 1 phase, less than 12 amps (15 amp circuit recommended)					
Water Content (Gallons)	1.75	3.00	4.25	5.50	6.75	
Dimensions	A-Height	29"	29"	29"	29"	
	B-Width	11"	14 1/4"	17 1/2"	20 3/4"	24"
	C-Depth	23 1/4"	23 1/4"	23 1/4"	23 1/4"	23 1/4"

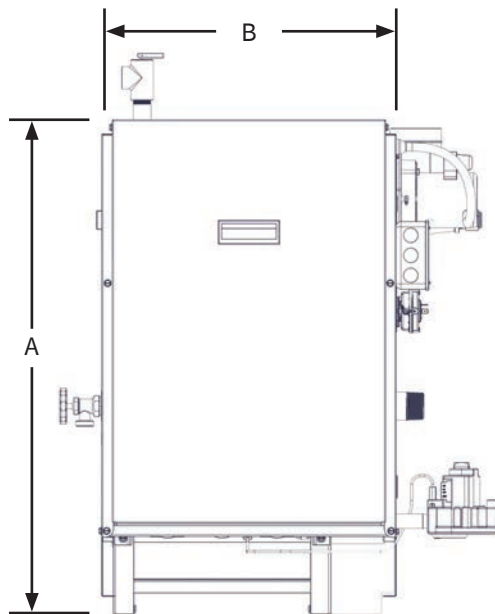

FRONT

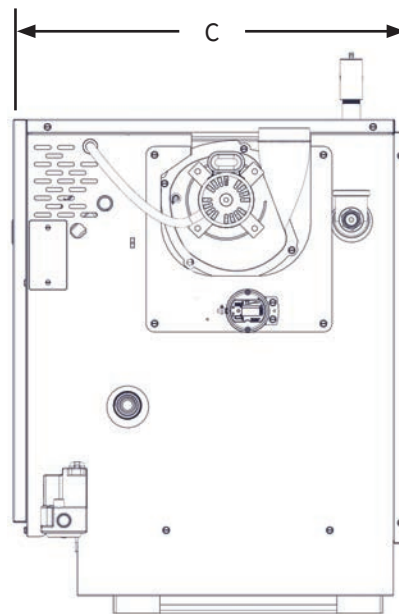

RIGHT SIDE

SVB - Cast Iron Induced Draft Chimney/Side Wall Vented Boilers									
Model	Item Number	Input MBH	Htg. Cap. MBH	AHRI Net MBH	AFUE	Fuel	Pump	Shp. Wgt. Lbs	Trade Price
SVB-2	SVB204203100310	42.5	36	31	84.4%	NAT	LESS	225	\$2,626
SVB-3	SVB307503100310	75.0	63	55	84.0%	NAT	LESS	265	\$2,972
SVB-4	SVB411203100310	112.5	95	82	84.0%	NAT	LESS	322	\$3,283
SVB-5	SVB515003100310	150.0	127	109	84.0%	NAT	LESS	370	\$3,691
SVB-6	SVB618703100310	187.5	158	135	84.0%	NAT	LESS	431	\$4,340
SVB-2	SVB204203140310	42.5	36	31	84.4%	NAT	TACO ECM	225	\$2,719
SVB-3	SVB307503140310	75.0	63	55	84.0%	NAT	TACO ECM	265	\$3,063
SVB-4	SVB411203140310	112.5	95	82	84.0%	NAT	TACO ECM	322	\$3,375
SVB-5	SVB515003140310	150.0	127	109	84.0%	NAT	TACO ECM	370	\$3,781
SVB-6	SVB618703140310	187.5	158	135	84.0%	NAT	TACO ECM	431	\$4,430
SVB-2	SVB204203120310	42.5	36	31	84.4%	NAT	GRUNDFOS	225	\$2,719
SVB-3	SVB307503120310	75.0	63	55	84.0%	NAT	GRUNDFOS	265	\$3,063
SVB-4	SVB411203120310	112.5	95	82	84.0%	NAT	GRUNDFOS	322	\$3,375
SVB-5	SVB515003120310	150.0	127	109	84.0%	NAT	GRUNDFOS	370	\$3,781
SVB-6	SVB618703120310	187.5	158	135	84.0%	NAT	GRUNDFOS	431	\$4,430
SVB-2	SVB204203130310	42.5	36	31	84.4%	NAT	B&G	225	\$2,719
SVB-3	SVB307503130310	75.0	63	55	84.0%	NAT	B&G	265	\$3,063
SVB-4	SVB411203130310	112.5	95	82	84.0%	NAT	B&G	322	\$3,375
SVB-5	SVB515003130310	150.0	127	109	84.0%	NAT	B&G	370	\$3,781
SVB-6	SVB618703130310	187.5	158	135	84.0%	NAT	B&G	431	\$4,430
SVB - LP									
SVB-2	SVB204213100310	42.5	36	31	84.4%	LP	LESS	225	\$2,689
SVB-3	SVB307513100310	75.0	63	55	84.0%	LP	LESS	265	\$3,034
SVB-4	SVB411213100310	112.5	95	82	84.0%	LP	LESS	322	\$3,345
SVB-5	SVB515013100310	150.0	127	109	84.0%	LP	LESS	370	\$3,753
SVB-6	SVB618713100310	187.5	158	135	84.0%	LP	LESS	431	\$4,401
SVB-2	SVB204213140310	42.5	36	31	84.4%	LP	TACO ECM	225	\$2,781
SVB-3	SVB307513140310	75.0	63	55	84.0%	LP	TACO ECM	265	\$3,124
SVB-4	SVB411213140310	112.5	95	82	84.0%	LP	TACO ECM	322	\$3,436
SVB-5	SVB515013140310	150.0	127	109	84.0%	LP	TACO ECM	370	\$3,843
SVB-6	SVB618713140310	187.5	158	135	84.0%	LP	TACO ECM	431	\$4,493
SVB-2	SVB204213120310	42.5	36	31	84.4%	LP	GRUNDFOS	225	\$2,781
SVB-3	SVB307513120310	75.0	63	55	84.0%	LP	GRUNDFOS	265	\$3,124
SVB-4	SVB411213120310	112.5	95	82	84.0%	LP	GRUNDFOS	322	\$3,436
SVB-5	SVB515013120310	150.0	127	109	84.0%	LP	GRUNDFOS	370	\$3,843
SVB-6	SVB618713120310	187.5	158	135	84.0%	LP	GRUNDFOS	431	\$4,493

SVB - Cast Iron Induced Draft Chimney/Side Wall Vented Boilers (Cont.)									
Model	Item Number	Input MBH	Htg. Cap. MBH	AHRI Net MBH	AFUE	Fuel	Pump	Shp. Wgt. Lbs	Trade Price
SVB-2	SVB204213130310	42.5	36	31	84.4%	LP	B&G	225	\$2,781
SVB-3	SVB307513130310	75.0	63	55	84.0%	LP	B&G	265	\$3,124
SVB-4	SVB411213130310	112.5	95	82	84.0%	LP	B&G	322	\$3,436
SVB-5	SVB515013130310	150.0	127	109	84.0%	LP	B&G	370	\$3,843
SVB-6	SVB618713130310	187.5	158	135	84.0%	LP	B&G	431	\$4,493

SVB - High Altitude									
SVB-2	SVB204203145310	42.5*	36*	31*	84.4%	NAT	TACO ECM	225	\$2,719
SVB-3	SVB307503145310	75*	63*	55*	84.0%	NAT	TACO ECM	265	\$3,063
SVB-4	SVB411203145310	112.5*	95*	82*	84.0%	NAT	TACO ECM	322	\$3,375
SVB-5	SVB515003145310	150*	127*	109*	84.0%	NAT	TACO ECM	370	\$3,781
SVB-6	SVB618703145310	187.5*	158*	135*	84.0%	NAT	TACO ECM	431	\$4,430
SVB-2	SVB204203125310	42.5*	36*	31*	84.4%	NAT	GRUNDFOS	225	\$2,719
SVB-3	SVB307503125310	75*	63*	55*	84.0%	NAT	GRUNDFOS	265	\$3,063
SVB-4	SVB411203125310	112.5*	95*	82*	84.0%	NAT	GRUNDFOS	322	\$3,375
SVB-5	SVB515003125310	150*	127*	109*	84.0%	NAT	GRUNDFOS	370	\$3,781
SVB-6	SVB618703125310	187.5*	158*	135*	84.0%	NAT	GRUNDFOS	431	\$4,430

**\* High Altitude - Capacity Reduces with Elevation. Refer to IOM for Actual Capacity Ratings.**  
**High Altitude Models ship with conversion kit (which must be field installed) at sea level with 5000' elevation orifices - consult factory for other elevations.**

SVB (Use Parts Multiplier for All of the Following)			
Model	Item Number	Description	Trade Price
SVB	550002722	NATURAL TO LP CONVERSION KIT (ALL SIZES)	\$99
SVB	43300660	LP TO NATURAL CONVERSION KIT (ALL SIZES)	\$108
SVB	14629014	4" THIMBLE (SIMPSON #915295)	\$47
SVB (2-5)	14629010	TJERNLUND VH-1-3" SIDE WALL VENT HOOD (SVB-2 TO SVB-5)	\$274
SVB (6)	14629011	TJERNLUND VH-1-4" SIDE WALL VENT HOOD (SVB-6)	\$325
SVB (2-5)	14624002	FILL-TROL #110 FOR WATER BOILERS 150 MBH OR LESS	\$347
SVB (6)	14624003	FILL-TROL #111 FOR WATER BOILERS OVER 150 MBH	\$481



**This page is intentionally left blank,  
products continue on the following page.**

# MGB-K Cast Iron Chimney Vented Boilers

- MBH Input 59 - 235 (CH)
- 84% AFUE
- Dependable Cast Iron Heat Exchanger
- Hydrolevel FuelSmart Control
- Digital temperature display and diagnostics
- Built-In Low Water Cut-Off (LWCO)
- Control monitors water temperature and delays burner start until residual heat has been transferred to the system for maximum efficiency
- Low profile draft hood diverter



General Information (See IOM for Complete Instructions)							
Model	MGB-060K	MGB-095K	MGB-120K	MGB-150K	MGB-175K	MGB-205K	MGB-235K
Water Return/Supply	1 1/4" NPT						
Gas	1/2" NPT				3/4" NPT		
Electrical	120 Volts AC, 60 hertz, 1 phase, less than 12 amps (15 amp circuit recommended)						
Water Content (Gallons)	1.9	2.3	2.8	3.2	3.7	4.1	4.6
A-Height	32 1/8"	32 1/8"	32 1/8"	32 1/8"	32 1/8"	32 1/8"	32 1/8"
B-Width	13 3/8"	13 1/2"	16 1/4"	19"	21 7/8"	27 1/2"	27 1/2"
C-Depth	26"	26"	26"	26"	26"	26"	26"

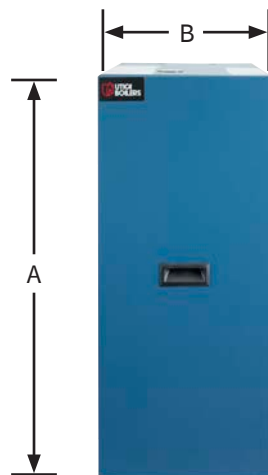

FRONT



LEFT SIDE

<b>MGB-K - Cast Iron Chimney Vented Boilers</b>									
<b>Model</b>	<b>Item Number</b>	<b>Input MBH</b>	<b>Htg. Cap. MBH</b>	<b>AHRI Net MBH</b>	<b>AFUE</b>	<b>Fuel</b>	<b>Pump</b>	<b>Shp. Wgt. lbs</b>	<b>Trade Price</b>
MGB-060K	MGB306003200310	59	50	43	84.0%	NAT	LESS	215	\$2,680
MGB-095K	MGB409503200310	92.5	78	68	84.0%	NAT	LESS	250	\$2,879
MGB-120K	MGB512003200310	120	101	88	84.0%	NAT	LESS	295	\$3,075
MGB-150K	MGB615003200310	149	125	109	84.0%	NAT	LESS	335	\$3,343
MGB-175K	MGB717503200310	175	147	128	84.0%	NAT	LESS	385	\$3,876
MGB-205K	MGB820503200310	205	172	150	84.0%	NAT	LESS	420	\$4,153
MGB-235K	MGB923503200310	235	197	171	84.0%	NAT	LESS	465	\$4,687
MGB-060K	MGB306003240310	59	50	43	84.0%	NAT	TACO ECM	215	\$2,778
MGB-095K	MGB409503240310	92.5	78	68	84.0%	NAT	TACO ECM	250	\$2,976
MGB-120K	MGB512003240310	120	101	88	84.0%	NAT	TACO ECM	295	\$3,173
MGB-150K	MGB615003240310	149	125	109	84.0%	NAT	TACO ECM	335	\$3,440
MGB-175K	MGB717503240310	175	147	128	84.0%	NAT	TACO ECM	385	\$3,974
MGB-205K	MGB820503240310	205	172	150	84.0%	NAT	TACO ECM	420	\$4,250
MGB-235K	MGB923503240310	235	197	171	84.0%	NAT	TACO ECM	465	\$4,785
MGB-060K	MGB306003220310	59	50	43	84.0%	NAT	GRUNDFOS	215	\$2,778
MGB-095K	MGB409503220310	92.5	78	68	84.0%	NAT	GRUNDFOS	250	\$2,976
MGB-120K	MGB512003220310	120	101	88	84.0%	NAT	GRUNDFOS	295	\$3,173
MGB-150K	MGB615003220310	149	125	109	84.0%	NAT	GRUNDFOS	335	\$3,440
MGB-175K	MGB717503220310	175	147	128	84.0%	NAT	GRUNDFOS	385	\$3,974
MGB-205K	MGB820503220310	205	172	150	84.0%	NAT	GRUNDFOS	420	\$4,250
MGB-235K	MGB923503220310	235	197	171	84.0%	NAT	GRUNDFOS	465	\$4,785
<b>MGB-K - LP</b>									
MGB-060K	MGB306013200310	59	50	43	84.0%	LP	LESS	215	\$2,741
MGB-095K	MGB409513200310	92.5	78	68	84.0%	LP	LESS	250	\$2,940
MGB-120K	MGB512013200310	120	101	88	84.0%	LP	LESS	295	\$3,137
MGB-150K	MGB615013200310	149	125	109	84.0%	LP	LESS	335	\$3,404
MGB-175K	MGB717513200310	175	147	128	84.0%	LP	LESS	385	\$3,937
MGB-205K	MGB820513200310	205	172	150	84.0%	LP	LESS	420	\$4,214
MGB-235K	MGB923513200310	235	197	171	84.0%	LP	LESS	465	\$4,749
MGB-060K	MGB306013240310	59	50	43	84.0%	LP	TACO ECM	215	\$2,839
MGB-095K	MGB409513240310	92.5	78	68	84.0%	LP	TACO ECM	250	\$3,038
MGB-120K	MGB512013240310	120	101	88	84.0%	LP	TACO ECM	295	\$3,234
MGB-150K	MGB615013240310	149	125	109	84.0%	LP	TACO ECM	335	\$3,502
MGB-175K	MGB717513240310	175	147	128	84.0%	LP	TACO ECM	385	\$4,035
MGB-205K	MGB820513240310	205	172	150	84.0%	LP	TACO ECM	420	\$4,312
MGB-235K	MGB923513240310	235	197	171	84.0%	LP	TACO ECM	465	\$4,846

<b>MGB-K - Cast Iron Chimney Vented Boilers (Cont.)</b>									
<b>Model</b>	<b>Item Number</b>	<b>Input MBH</b>	<b>Htg. Cap. MBH</b>	<b>AHRI Net MBH</b>	<b>AFUE</b>	<b>Fuel</b>	<b>Pump</b>	<b>Shp. Wgt. lbs</b>	<b>Trade Price</b>
MGB-060K	MGB306013220310	59	50	43	84.0%	LP	GRUNDFOS	215	\$2,839
MGB-095K	MGB409513220310	92.5	78	68	84.0%	LP	GRUNDFOS	250	\$3,038
MGB-120K	MGB512013220310	120	101	88	84.0%	LP	GRUNDFOS	295	\$3,234
MGB-150K	MGB615013220310	149	125	109	84.0%	LP	GRUNDFOS	335	\$3,502
MGB-175K	MGB717513220310	175	147	128	84.0%	LP	GRUNDFOS	385	\$4,035
MGB-205K	MGB820513220310	205	172	150	84.0%	LP	GRUNDFOS	420	\$4,312
MGB-235K	MGB923513220310	235	197	171	84.0%	LP	GRUNDFOS	465	\$4,846

<b>MGB-K - High Altitude*</b>									
MGB-060K	MGB306003245310	59*	50*	43*	84.0%	NAT	TACO ECM	215	\$2,778
MGB-095K	MGB409503245310	92.5*	78*	68*	84.0%	NAT	TACO ECM	250	\$2,976
MGB-120K	MGB512003245310	120*	101*	88*	84.0%	NAT	TACO ECM	295	\$3,173
MGB-150K	MGB615003245310	149*	125*	109*	84.0%	NAT	TACO ECM	335	\$3,440
MGB-175K	MGB717503245310	175*	147*	128*	84.0%	NAT	TACO ECM	385	\$3,974
MGB-205K	MGB820503245310	205*	172*	150*	84.0%	NAT	TACO ECM	420	\$4,250
MGB-235K	MGB923503245310	235*	197*	171*	84.0%	NAT	TACO ECM	465	\$4,785

**\* High Altitude - Capacity Reduces with Elevation. Refer to IOM for Actual Capacity Ratings.**

**High Altitude Models ship with conversion kit (which must be field installed) at sea level with 5000' elevation orifices - consult factory for other elevations.**

<b>MGB-K (Use Parts Multiplier for All of the Following)</b>			
<b>Model</b>	<b>Item Number</b>	<b>Description</b>	<b>Trade Price</b>
MGB-K	550003778	CONVERSION KIT NAT. TO LP	\$80
MGB-K	550003884	CONVERSION KIT LP TO NAT.	\$88
MGB-K	14624002	FILL-TROL #110 FOR WATER BOILERS 150 MBH OR LESS	\$347
MGB-K	14624003	FILL-TROL #111 FOR WATER BOILERS OVER 150 MBH	\$481

<b>MGC - Cast Iron Chimney Vented Boilers</b>									
<b>Model</b>	<b>Current Item Number</b>	<b>Input MBH</b>	<b>Htg. Cap. MBH</b>	<b>AHRI Net MBH</b>	<b>AFUE</b>	<b>Fuel</b>	<b>Pump</b>	<b>Shp. Wgt. lbs</b>	<b>Trade Price</b>
MGC-8D	MGC826203200310	262	221	192	84.0%	NAT	LESS	552	\$4,816
MGC-9D	MGC929903200310	299	252	219	84.0%	NAT	LESS	616	\$5,540
MGC-8D	MGC826203240310	262	221	192	84.0%	NAT	TACO ECM	552	\$4,914
MGC-9D	MGC929903240310	299	252	219	84.0%	NAT	TACO ECM	616	\$5,638
MGC-8D	MGC826203220310	262	221	192	84.0%	NAT	GRUNDFOS	552	\$4,914
MGC-9D	MGC929903220310	299	252	219	84.0%	NAT	GRUNDFOS	616	\$5,638
<b>MGC - High Altitude*</b>									
MGC-8D	MGC826203245310	262*	221*	191*	84.0%	NAT	TACO ECM	552	\$4,914
MGC-9D	MGC929903245310	299*	252*	219*	84.0%	NAT	TACO ECM	616	\$5,638

**\* High Altitude - Capacity Reduces with Elevation. Refer to IOM for Actual Capacity Ratings.**

**High Altitude Models ship with conversion kit (which must be field installed) at sea level with 5000' elevation orifices - consult factory for other elevations.**

<b>MGC (Use Parts Multiplier for All of the Following)</b>			
<b>Model</b>	<b>Item Number</b>	<b>Description</b>	<b>Trade Price</b>
MGC	550004168	CONVERSION KIT NAT. TO LP MGC-8/9	\$108
MGC-8D	43300636	CONVERSION KIT LP TO NAT. MGC-8	\$219
MGC-9D	43300637	CONVERSION KIT LP TO NAT. MGC-9	\$219
MGC	14624002	FILL-TROL #110 FOR WATER BOILERS 150 MBH OR LESS	\$347
MGC	14624003	FILL-TROL #111 FOR WATER BOILERS OVER 150 MBH	\$481

# PEG-E Cast Iron Steam Boilers

- MBH Input 75 - 299 (CH)
- Up to 83.4% AFUE
- 7 Sizes Available
- Dependable Cast Iron Heat Exchanger
- Electronic ignition system
- Automatic Vent Damper
- LWCO (Probe Type) externally mounted for quick access
- Pressure High Limit Control with Pressure Gauge and Gauge Glass
- Stainless Steel Burners
- Easy Serviceability



General Information (See IOM for Complete Instructions)							
Model	PEG075EID	PEG112EID	PEG150EID	PEG187EID	PEG225EID	PEG262EID	PEG299EID
Return/Supply Tappings	2" NPT						
Gas	1/2" NPT			3/4" NPT			
Electrical	120 Volts AC, 60 hertz, 1 phase, less than 12 amps (15 amp circuit recommended)						
A-Height	35 7/8"	35 7/8"	35 7/8"	35 7/8"	35 7/8"	35 7/8"	35 7/8"
B-Width	10 7/8"	14 1/8"	17 3/8"	20 5/8"	23 7/8"	27 1/8"	30 3/8"
C-Depth	28 3/8"	28 3/8"	29 3/8"	30 3/8"	30 3/8"	30 3/8"	30 3/8"

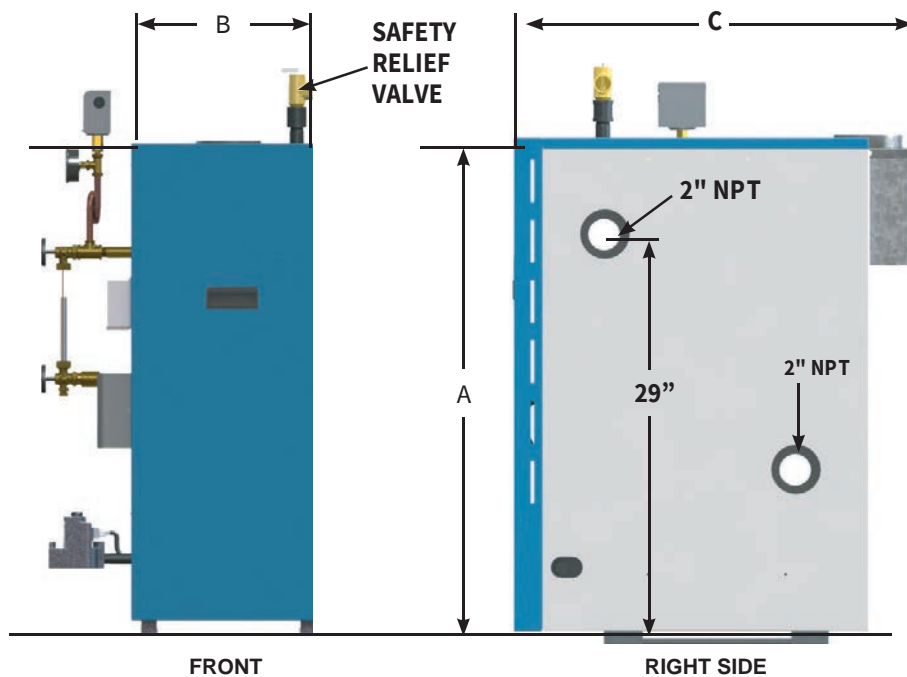

<b>PEG E - Cast Iron Steam Boiler</b>									
<b>Model</b>	<b>Item Number</b>	<b>Input MBH</b>	<b>Htg. Cap. MBH</b>	<b>AHRI Net MBH</b>	<b>AHRI Net SQ. FT. Steam</b>	<b>AFUE</b>	<b>Fuel</b>	<b>Shp. Wgt. lbs</b>	<b>Trade Price</b>
PEG075EID	PEG307503100510	75	62	47	195	82.2%	NAT	297	\$3,561
PEG112EID	PEG411203100510	112	93	70	292	82.4%	NAT	368	\$3,932
PEG150EID	PEG515003100510	150	125	94	391	82.6%	NAT	440	\$4,279
PEG187EID	PEG618703100510	187	156	117	488	82.8%	NAT	512	\$4,605
PEG225EID	PEG722503100510	225	188	141	587	83.0%	NAT	584	\$5,409
PEG262EID	PEG826203100510	262	219	164	685	83.2%	NAT	659	\$5,805
PEG299EID	PEG929903100510	299	250	188	782	83.4%	NAT	736	\$6,289

<b>PEG E - LP</b>									
PEG075EID	PEG307513100510	75	62	47	195	82.2%	LP	297	\$3,626
PEG112EID	PEG411213100510	112	93	70	292	82.4%	LP	368	\$4,000
PEG150EID	PEG515013100510	150	125	94	391	82.6%	LP	440	\$4,346
PEG187EID	PEG618713100510	187	156	117	488	82.8%	LP	512	\$4,673
PEG225EID	PEG722513100510	225	188	141	587	83.0%	LP	584	\$5,477
PEG262EID	PEG826213100510	262	219	164	685	83.2%	LP	659	\$5,869
PEG299EID	PEG929913100510	299	250	188	782	83.4%	LP	736	\$6,354

<b>PEG E (Use Parts Multiplier for All of the Following)</b>			
<b>Model</b>	<b>Item Number</b>	<b>Description</b>	<b>Trade Price</b>
PEG	550002702	CONVERSION KIT NAT. TO LP (3 - 5 SECTION)	\$66
PEG	550002703	CONVERSION KIT NAT. TO LP (6 - 9 SECTION)	\$69
PEG	550002704	CONVERSION KIT LP TO NAT. (3 - 5 SECTION)	\$72
PEG	550002705	CONVERSION KIT LP TO NAT. (6 - 9 SECTION)	\$95
PEG	1630001	MCDONNELL & MILLER WF-2U-24 ELECTRONIC WATER FEEDER	\$554

## JE COMMERCIAL Cast Iron Commercial Steam Boilers

JE Commercial Bases are pre-assembled at the factory with burner manifold, burner orifices, gas valves and electronic ignition installed; ready for field installation of the pre-tested sections and appropriate packages.

### Electronic Ignition Base Standard Equipment:

- Base
- Fire Door
- Burner Orifice
- Manifold
- Main and Pilot Burner
- Electronic Pilot Gas Valve
- Intermittent Pilot Module
- Complete Jacket Assembly

### Steam Trim Package:

- Low Water Cut-Off
- Glass Gauge Set
- Safety Valve
- Steam Gauge
- Pressure Limit
- Drain Valve



### Plug 'N Play Harness and Junction Box

Individual base and junction box controls are designed for easy installation. The entire boiler links together in a snap with a color-coded factory supplied wiring harness

### CSD-1 Options

Available with a CSD-1 option to comply with CSD-1 standards where required by building code. The CSD-1 option provides the increased number of controls and safety devices required to meet CSD-1 standards.

General Information (See IOM for Complete Instructions)			
	Right & Left End Tappings	Opening	Size
	Return/Supply	A	4"
	Primary LWCO & Gauge Glass Set	B	1/2"
	Drain, Left End	C	3/4"
	Drain, Right End	C	3/4"
	Plugged	D	1/2"
	Accessories	E	1"
	Safety Valve	F*	1"
	Plugged or Electronic (Probe Type) LWCO	G	3/4"
	*If using opening F for other than Safety Valve or Safety Relief Valve, or Safety/Relief valve is larger than 1", Install Safety/Relief Valve in Header Piping as near boiler as possible.		



<b>JE - Cast Iron Commercial Steam Boiler</b>										
<b>Model</b>	<b>Item Number</b>	<b>Type*</b>	<b>Input MBH</b>	<b>Output MBH</b>	<b>Net AHRI Ratings</b>			<b>Therm. Eff.</b>	<b>Shp. Wgt. Lbs</b>	<b>Trade Price</b>
					<b>Steam PPF</b>	<b>Steam SQ. FT.</b>	<b>Steam BTU (MBH)</b>			
JE-300S	CBA030003101110	STD.	300	233	1.33	729	175	77.0%	1000	\$7,286
JE-400S	CBA040003101110	STD.	400	310	1.33	971	233	77.0%	1200	\$8,107
JE-500S	CBA050003101110	STD.	500	388	1.33	1213	291	77.0%	1400	\$9,119
JE-600S	CBA060003101110	STD.	600	465	1.33	1454	349	77.0%	1600	\$11,855
JE-700S	CBA070003101110	STD.	700	543	1.33	1696	407	77.0%	1800	\$12,772
JE-800S	CBA080003101110	STD.	800	620	1.33	1938	465	77.0%	2000	\$13,725
JE-900S	CBA090003101110	STD.	900	698	1.33	2183	524	77.0%	2200	\$14,731
JE-1000S	CBA100003101110	STD.	1000	775	1.33	2421	581	77.0%	2400	\$15,644
JE-1100S	CBA110003101110	STD.	1100	853	1.33	2667	640	77.0%	2600	\$18,453
JE-1200S	CBA120003101110	STD.	1200	930	1.33	2908	698	77.0%	2900	\$19,367
JE-1300S	CBA130003101110	STD.	1300	1008	1.33	3150	756	77.0%	3100	\$20,817
JE-1400S	CBA140003101110	STD.	1400	1085	1.33	3392	814	77.0%	3300	\$21,733
JE-1500S	CBA150003101110	STD.	1500	1163	1.33	3633	872	77.0%	3500	\$22,671
JE-300S	CBA030003103110	G.R.S.	300	233	1.33	729	175	77.0%	1000	\$8,136
JE-400S	CBA040003103110	G.R.S.	400	310	1.33	971	233	77.0%	1200	\$9,048
JE-500S	CBA050003103110	G.R.S.	500	388	1.33	1213	291	77.0%	1400	\$9,961
JE-600S	CBA060003103110	G.R.S.	600	465	1.33	1454	349	77.0%	1600	\$13,659
JE-700S	CBA070003103110	G.R.S.	700	543	1.33	1696	407	77.0%	1800	\$14,593
JE-800S	CBA080003103110	G.R.S.	800	620	1.33	1938	465	77.0%	2000	\$15,542
JE-900S	CBA090003103110	G.R.S.	900	698	1.33	2183	524	77.0%	2200	\$16,547
JE-1000S	CBA100003103110	G.R.S.	1000	775	1.33	2421	581	77.0%	2400	\$17,456
JE-1100S	CBA110003103110	G.R.S.	1100	853	1.33	2667	640	77.0%	2600	\$20,632
JE-1200S	CBA120003103110	G.R.S.	1200	930	1.33	2908	698	77.0%	2900	\$21,544
JE-1300S	CBA130003103110	G.R.S.	1300	1008	1.33	3150	756	77.0%	3100	\$22,989
JE-1400S	CBA140003103110	G.R.S.	1400	1085	1.33	3392	814	77.0%	3300	\$23,906
JE-1500S	CBA150003103110	G.R.S.	1500	1163	1.33	3633	872	77.0%	3500	\$24,841
JE-300S	CBA030003104110	F.P.R.	300	233	1.33	729	175	77.0%	1000	\$9,004
JE-400S	CBA040003104110	F.P.R.	400	310	1.33	971	233	77.0%	1200	\$9,916
JE-500S	CBA050003104110	F.P.R.	500	388	1.33	1213	291	77.0%	1400	\$10,834
JE-600S	CBA060003104110	F.P.R.	600	465	1.33	1454	349	77.0%	1600	\$14,531
JE-700S	CBA070003104110	F.P.R.	700	543	1.33	1696	407	77.0%	1800	\$15,462
JE-800S	CBA080003104110	F.P.R.	800	620	1.33	1938	465	77.0%	2000	\$16,411
JE-900S	CBA090003104110	F.P.R.	900	698	1.33	2183	524	77.0%	2200	\$17,416
JE-1000S	CBA100003104110	F.P.R.	1000	775	1.33	2421	581	77.0%	2400	\$18,327
JE-1100S	CBA110003104110	F.P.R.	1100	853	1.33	2667	640	77.0%	2600	\$21,501
JE-1200S	CBA120003104110	F.P.R.	1200	930	1.33	2908	698	77.0%	2900	\$22,415
JE-1300S	CBA130003104110	F.P.R.	1300	1008	1.33	3150	756	77.0%	3100	\$23,861
JE-1400S	CBA140003104110	F.P.R.	1400	1085	1.33	3392	814	77.0%	3300	\$24,776
JE-1500S	CBA150003104110	F.P.R.	1500	1163	1.33	3633	872	77.0%	3500	\$25,711

**\*Type (STD. - Standard) (G.R.S. - CSD-1 Gravity Return System) (F.P.R. - CSD-1 Boiler Feed Pump Return Control)**

**JE - Knock Down Components & Optional Equipment**

<b>Model</b>	<b>Item Number</b>	<b>Description</b>	<b>Trade Price</b>
JE	41154050U	CAST IRON SECTIONS - RIGHT END (179 LBS.)	\$817
JE	41154051U	CAST IRON SECTIONS - LEFT END (182 LBS.)	\$817
JE	41154052U	CAST IRON SECTIONS - INTERMEDIATE (165 LBS.)	\$716
JE-300S	550002861U	COMPONENT CARTON - 300	\$2,180
JE-400S	550002862U	COMPONENT CARTON - 400	\$2,307
JE-500S	550002863U	COMPONENT CARTON - 500	\$2,422
JE-300S	550002890U	COMPONENT CARTON - 300 CSD-1	\$2,545
JE-400S	550002891U	COMPONENT CARTON - 400 CSD-1	\$2,674
JE-500S	550002892U	COMPONENT CARTON - 500 CSD-1	\$2,786
JE	550002871U	END PANEL CARTON - JACKET	\$317
JE	550002860U	END PANEL CARTON - BASE	\$289
JE	41200061U	STEAM TRIM - SA 1 (SIZES/MODELS: 300 -500)	\$1,063
JE	41200062U	STEAM TRIM - SA 2 (SIZES/MODELS: 600 - 700)	\$1,078
JE	41200063U	STEAM TRIM - SA 3 (SIZES/MODELS: 800 - 1400)	\$1,108
JE	41200064U	STEAM TRIM - SA 4 (SIZES/MODELS: 1500)	\$1,117
JE-300S	550002877US	ACCESSORY CARTON - 300	\$372
JE-400S	550002878US	ACCESSORY CARTON - 400	\$439
JE-500S	550002867US	ACCESSORY CARTON - 500	\$529
JE-600S	550002879US	ACCESSORY CARTON - 600	\$598
JE-700S	550002880US	ACCESSORY CARTON - 700	\$669
JE-800S	550002881US	ACCESSORY CARTON - 800	\$776
JE-900S	550002882US	ACCESSORY CARTON - 900	\$922
JE-1000S	550002868US	ACCESSORY CARTON - 1000	\$1,006
JE-1100S	550002883US	ACCESSORY CARTON - 1100	\$1,150
JE-1200S	550002884US	ACCESSORY CARTON - 1200	\$1,208
JE-1300S	550002885US	ACCESSORY CARTON - 1300	\$1,841
JE-1400S	550002886US	ACCESSORY CARTON - 1400	\$1,914
JE-1500S	550002869US	ACCESSORY CARTON - 1500	\$2,020
JE	41257103U	CSD-1 STEAM TRIM - GRAVITY/CONDENSATE (ALL SIZES)	\$484
JE	41257104U	CSD-1 STEAM TRIM - FEED PUMP (ALL SIZES)	\$1,353
JE-300S	550002893US	CSD-1 ACCESSORY CARTON - 300	\$372
JE-400S	550002894US	CSD-1 ACCESSORY CARTON - 400	\$439
JE-500S	550002895US	CSD-1 ACCESSORY CARTON - 500	\$529
JE-600S	550002896US	CSD-1 ACCESSORY CARTON - 600	\$1,193
JE-700S	550002897US	CSD-1 ACCESSORY CARTON - 700	\$1,282
JE-800S	550002898US	CSD-1 ACCESSORY CARTON - 800	\$1,360
JE-900S	550002899US	CSD-1 ACCESSORY CARTON - 900	\$1,534
JE-1000S	550002900US	CSD-1 ACCESSORY CARTON - 1000	\$1,618
JE-1100S	550002901US	CSD-1 ACCESSORY CARTON - 1100	\$1,760
JE-1200S	550002902US	CSD-1 ACCESSORY CARTON - 1200	\$1,831
JE-1300S	550002903US	CSD-1 ACCESSORY CARTON - 1300	\$2,462
JE-1400S	550002904US	CSD-1 ACCESSORY CARTON - 1400	\$2,536
JE-1500S	550002905US	CSD-1 ACCESSORY CARTON - 1500	\$2,612

<b>JE (Use Parts Multiplier for All of the Following)</b>			
<b>Model</b>	<b>Item Number</b>	<b>Description</b>	<b>Trade Price</b>
JE	14662311	STEAM MANUAL RESET PRESSURE CONTROL (L4079B1033)	\$317
JE	1280001	M-M 47-2 LWCO & FEEDER (MODELS 300-1500)	\$1,426
JE	14662313	STRAP ON OPERATING CONTROL (L6006C-1034)	\$191
JE	240007388	LWCO, MAN RESET, CSD-1 APPROVED, SHT PROBE	\$252

**JE- Standard Equipment**

Standard Equipment:

(67 Low Water Cut-Off, PA404A Pressuretrol and Syphon Loop, Water Gauge Glass Set with Glass and Rods, Steam Gauge, Pop Safety Valve).

**CSD-1 Control Requirements**

The optional CSD-1 controls modify the standard JE boiler on both the fuel train and the steam trim as follows:

**STEAM BOILER WITH BOILER FEED PUMP RETURN SYSTEM**

- Add SF-500 Hydrolevel Safeguard Manual Reset L.W.C.O.
- Add 150S-B-MD L.W.C.O. and Pump Control
- Delete 67D-1 L.W.C.O.
- Add L404L Manual Reset Pressure Control

**STEAM BOILER WITH GRAVITY OR CONDENSATE PUMP RETURN SYSTEM**

- Add SF-500 Hydrolevel Safeguard Manual Reset L.W.C.O.
- Add L404C Manual Reset Pressure Control

The SF-500 L.W.C.O. is the secondary L.W.C.O. to the 67D-1 L.W.C.O. furnished standard with the boiler.

**FUEL TRAIN**

Substitute CSD-1 fuel train(s) for standard which includes (per base): Intermittent Pilot Module (PT#1140007) control Stop w/alarm 1003-612A & (PT#1140008) Control CSD1 Lockout Board BD 1145-2 with manual reset; Independent Pilot Gas Line (Manual shut-off valve, Pressure regulator, Safety shut-off valve); Main Gas Line (Gas Valve, Two leak test cocks, Manual shut-off downstream of the main gas valve).

**NOTES:**

1. The JE-300 and JE-400 do not require fuel train modifications for CSD-1. The standard fuel train is furnished.
2. Control equipment is included to meet Utica's interpretation of CSD-1. Consult local authorities before the installation of the boiler. Additional controls, if required can be provided at an additional price.

## TRIFIRE TRB Cast Iron 3-Pass Oil Boilers

- MBH Input 105 - 266 (CH)
- Up to 87% AFUE, ENERGY STAR® Certified Models
- Advanced High Efficiency 3-Pass Heat Exchanger Design
- High Limit Control with:
  - LED display
  - Easy to program dial settings
  - Boiler Water Temperature Reset
  - Low Water Cut Off (LWCO)
- Compact Footprint
- Burners and Venting Options
- Easy Serviceability



General Information (See IOM for Complete Instructions)				
Model	TRB4	TRB5	TRB6	TRB7
Water Return/Supply	1 1/4" NPT			
Drain Valve	3/4" NPT			
Electrical	120 Volts AC, 60 hertz, 1 phase, less than 12 amps (15 amp circuit recommended)			
Water Content (Gallons)	3.6	4.3	5.1	5.9
Dimensions	A-Height	31"	31"	31"
	B-Width	17 3/4"	17 3/4"	17 3/4"
	C-Depth	18 3/8"	21 5/8"	24 7/8"

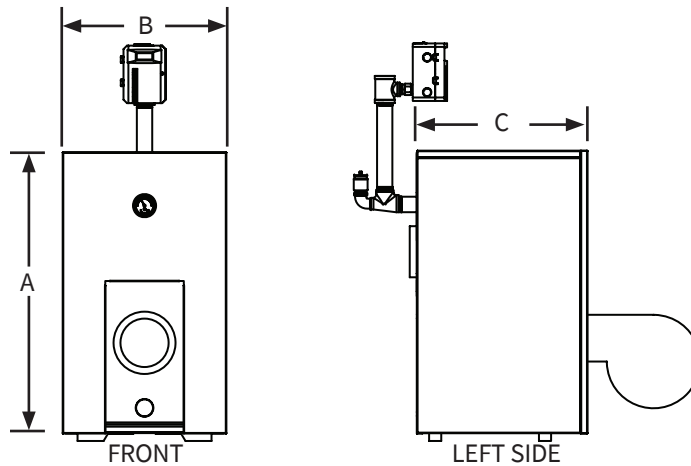

## DHW MODULE Domestic Hot Water Module (Sold Separately)

- The Domestic Hot Water (DHW) Module is a great way to make domestic hot water using an existing boiler
- Digital control has the ability to set a consistent DHW temperature from 108°F - 140°F
- Brazed plate stainless steel heat exchanger offers lower pressure drop than tankless water coils with nearly 100% heat transfer efficiency
- Simple and flexible installation - mounts on a wall near the boiler as an additional heating zone
- Compact design with insulated cover and a standard 120 volt power cord
- Easy to service and clean



**TRIFIRE TRB Series 3 - Cast Iron 3-Pass Oil Boiler**

Model	Item Number	Input MBH	Htg. Cap. MBH	AHRI Net MBH	AFUE	Fuel	Burner	Pump	Shp. Wgt. lbs	Trade Price
TRB4075	TRB407530200310	105	92	80	87.0%	OIL	BECKETT	LESS	436	\$3,118
TRB4090	TRB409030200310	126	110	96	86.0%	OIL	BECKETT	LESS	436	\$3,118
TRB5100	TRB510030200310	140	123	107	87.0%	OIL	BECKETT	LESS	496	\$3,561
TRB6130	TRB613030200310	182	160	139	87.0%	OIL	BECKETT	LESS	560	\$3,758
TRB7165	TRB716530200310	231	202	176	87.0%	OIL	BECKETT	LESS	620	\$4,299
TRB4075	TRB407530240310	105	92	80	87.0%	OIL	BECKETT	TACO ECM	436	\$3,213
TRB4090	TRB409030240310	126	110	96	86.0%	OIL	BECKETT	TACO ECM	436	\$3,213
TRB5100	TRB510030240310	140	123	107	87.0%	OIL	BECKETT	TACO ECM	496	\$3,656
TRB6130	TRB613030240310	182	160	139	87.0%	OIL	BECKETT	TACO ECM	560	\$3,854
TRB7165	TRB716530240310	231	202	176	87.0%	OIL	BECKETT	TACO ECM	620	\$4,394
TRB4075	TRB407530220310	105	92	80	87.0%	OIL	BECKETT	GRUNDFOS	436	\$3,213
TRB4090	TRB409030220310	126	110	96	86.0%	OIL	BECKETT	GRUNDFOS	436	\$3,213
TRB5100	TRB510030220310	140	123	107	87.0%	OIL	BECKETT	GRUNDFOS	496	\$3,656
TRB6130	TRB613030220310	182	160	139	87.0%	OIL	BECKETT	GRUNDFOS	560	\$3,854
TRB7165	TRB716530220310	231	202	176	87.0%	OIL	BECKETT	GRUNDFOS	620	\$4,394
TRB4075	TRB407550200310	105	92	80	87.0%	OIL	RIELLO	LESS	436	\$3,259
TRB4090	TRB409050200310	126	110	96	86.0%	OIL	RIELLO	LESS	436	\$3,259
TRB5100	TRB510050200310	140	123	107	87.0%	OIL	RIELLO	LESS	496	\$3,759
TRB6130	TRB613050200310	182	160	139	87.0%	OIL	RIELLO	LESS	560	\$3,958
TRB7165	TRB716550200310	231	202	176	87.0%	OIL	RIELLO	LESS	620	\$4,299
TRB4075	TRB407550240310	105	92	80	87.0%	OIL	RIELLO	TACO ECM	436	\$3,344
TRB4090	TRB409050240310	126	110	96	86.0%	OIL	RIELLO	TACO ECM	436	\$3,355
TRB5100	TRB510050240310	140	123	107	87.0%	OIL	RIELLO	TACO ECM	496	\$3,855
TRB6130	TRB613050240310	182	160	139	87.0%	OIL	RIELLO	TACO ECM	560	\$4,054
TRB7165	TRB716550240310	231	202	176	87.0%	OIL	RIELLO	TACO ECM	620	\$4,413
TRB4075	TRB407550220310	105	92	80	87.0%	OIL	RIELLO	GRUNDFOS	436	\$3,355
TRB4090	TRB409050220310	126	110	96	86.0%	OIL	RIELLO	GRUNDFOS	436	\$3,355
TRB5100	TRB510050220310	140	123	107	87.0%	OIL	RIELLO	GRUNDFOS	496	\$3,855
TRB6130	TRB613050220310	182	160	139	87.0%	OIL	RIELLO	GRUNDFOS	560	\$4,054
TRB7165	TRB716550220310	231	202	176	87.0%	OIL	RIELLO	GRUNDFOS	620	\$4,413
TRB4090	TRB409020240310	105	92	80	87.0%	OIL	LESS	TACO ECM	436	\$2,420
TRB5100	TRB510020240310	126	110	96	86.0%	OIL	LESS	TACO ECM	496	\$2,817
TRB6130	TRB613020240310	182	160	139	87.0%	OIL	LESS	TACO ECM	560	\$3,098
TRB7165	TRB716520240310	231	202	176	87.0%	OIL	LESS	TACO ECM	620	\$3,464
TRB4090	TRB409020200310	105	92	80	87.0%	OIL	LESS	LESS	436	\$2,323
TRB5100	TRB510020200310	126	110	96	86.0%	OIL	LESS	LESS	496	\$2,722
TRB6130	TRB613020200310	182	160	139	87.0%	OIL	LESS	LESS	560	\$3,004
TRB7165	TRB716520200310	231	202	176	87.0%	OIL	LESS	LESS	620	\$3,370

<b>TRIFIRE TRB - Venting Options &amp; Additional Equipment</b>			
<b>Model</b>	<b>Item Number</b>	<b>Description</b>	<b>Trade Price</b>
TRB	29231U	36" RISER TERMINATION	\$1,414
TRB	28972U	STANDARD TERMINATION	\$603
TRB	550004240U	4" ID X 10 FT DIRECT VENT PIPE KIT (SELECT TERMINATION)	\$695
TRB	550004241U	4" ID X 15 FT DIRECT VENT PIPE KIT (SELECT TERMINATION)	\$832
TRB	550004242U	4" ID X 20 FT DIRECT VENT PIPE KIT (SELECT TERMINATION)	\$982
<b>TRIFIRE TRB - Replacement Oil Burners</b>			
TRB4075	240007232U	BECKETT CHIMNEY VENT W/O COVER MODEL AFG	\$748
TRB4090	240013303U	BECKETT CHIMNEY VENT W/O COVER MODEL AFG	\$748
TRB5100	240007233U	BECKETT CHIMNEY VENT W/O COVER MODEL AFG	\$792
TRB6130	240007234U	BECKETT CHIMNEY VENT W/O COVER MODEL AFG	\$713
TRB7165	240007235U	BECKETT CHIMNEY VENT W/O COVER MODEL AFG	\$781
TRB4075	240007144U	BECKETT CHIMNEY VENT WITH COVER MODEL AFG	\$799
TRB4090	240013302U	BECKETT CHIMNEY VENT WITH COVER MODEL AFG	\$799
TRB5100	240007145U	BECKETT CHIMNEY VENT WITH COVER MODEL AFG	\$843
TRB6130	240007146U	BECKETT CHIMNEY VENT WITH COVER MODEL AFG	\$766
TRB7165	240007183U	BECKETT CHIMNEY VENT WITH COVER MODEL AFG	\$832
TRB4075	550004238U	BECKETT DIRECT VENT MODEL NX	\$955
TRB5100	240007532U	BECKETT DIRECT VENT MODEL NX	\$995
TRB6130	240007533U	BECKETT DIRECT VENT MODEL NX	\$920
TRB4075	550003548U	RIELLO CHIMNEY VENT MODEL 40F	\$881
TRB4090	550004237U	RIELLO CHIMNEY VENT MODEL 40F	\$881
TRB5100	550003551U	RIELLO CHIMNEY VENT MODEL 40F	\$980
TRB6130	550003554U	RIELLO CHIMNEY VENT MODEL 40F	\$906
TRB7165	550003557U	RIELLO CHIMNEY VENT MODEL 40F	\$900
TRB4075	550004239U	RIELLO DIRECT VENT MODEL 40BF	\$1,286
TRB5100	550003563U	RIELLO DIRECT VENT MODEL 40BF	\$1,384
TRB6130	550003566U	RIELLO DIRECT VENT MODEL 40BF	\$1,304
TRB4075	240013299U	CARLIN CHIMNEY VENT EZ-LF	\$806
TRB4090	240013299U	CARLIN CHIMNEY VENT EZ-LF	\$806
TRB5100	240013304U	CARLIN CHIMNEY VENT EZ-LF	\$806
<b>TRIFIRE TRB (Use Parts Multiplier for All of the Following)</b>			
TRB	550001929	KIT, HIGH LIMIT MANUAL RESET L4006E1109 WITH PLUG IN HARNESS	\$264
TRB	14624002	FILL-TROL FOR WATER BOILERS 150 MBH OR LESS	\$347
TRB	14624003	FILL-TROL FOR WATER BOILERS OVER 150 MBH	\$481

<b>DOMESTIC HOT WATER (DHW) MODULE</b>			
<b>Model</b>	<b>Item Number</b>	<b>Description</b>	<b>Trade Price</b>
550003792	550003792U	DOMESTIC HOT WATER MODULE	\$973

**This page is intentionally left blank,  
products continue on the following page.**

# STARFIRE SFH Cast Iron Chimney Vented Oil Boilers

- MBH Input 119 - 259 (CH)
- Up to 87% AFUE
- Dependable Cast Iron Heat Exchanger with Cast Iron Push Nipples
- Hydrolevel Operating Control
  - Digital Temperature display and diagnostics
  - Adjusts water temperature based on heating system demand
  - Built-In Low Water Cut-Off (LWCO)
  - Boiler Reset
- Burner swing door for easy serviceability
- Multiple Firing Rates
- Optional tankless domestic hot water (DHW) coil



General Information (See IOM for Complete Instructions)				
Model	SFH-3085WT	SFH-4100WT SFH-4125WT	SFH-5160WT	SFH-6175WT
Water Return/Supply	1 1/2" Return NPT, 2" Supply NPT			
Oil	3/8" O.D. Copper (runs 50' or less, 1/2" O.D. Copper (runs over 50')			
Electrical	120 Volts AC, 60 hertz, 1 phase, less than 12 amps (15 amp circuit recommended)			
Water Content (Gallons)	10.5	13.5	16.5	19.5
Dimensions	A-Height	35"	35"	35"
	B-Width	21 13/16"	21 13/16"	21 13/16"
	C-Depth	17 7/8"	21 1/2"	25 1/8"

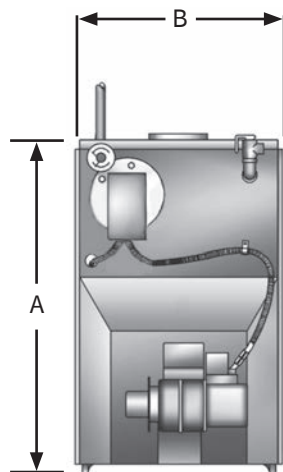

FRONT

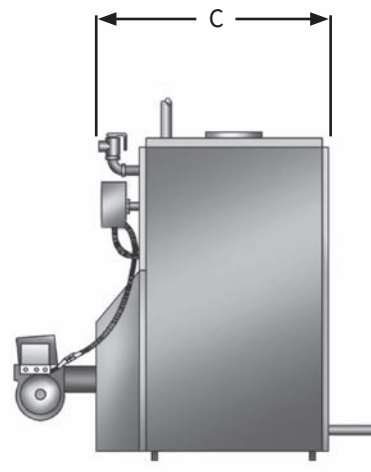

RIGHT SIDE



STARFIRE SFH - Cast Iron Chimney Vent Oil Boiler											
Model	Item Number	Type *	Input MBH	Htg. Cap. MBH	AHRI Net MBH	AFUE	Burner	Pump	Firing Rate GPH	Shp. Wgt. Lbs	Trade Price
SFH-3085W	SFH308530200510	C.O.	119	103	90	86.0%	BECKETT	LESS	0.85	534	\$3,848
SFH-4100W	SFH410030200510	C.O.	140	124	108	87.0%	BECKETT	LESS	1.00	668	\$4,047
SFH-4125W	SFH412530200510	C.O.	175	152	132	86.0%	BECKETT	LESS	1.25	668	\$4,047
SFH-5160W	SFH516030200510	C.O.	224	195	170	86.0%	BECKETT	LESS	1.60	781	\$5,171
SFH-6185W	SFH618530200510	C.O.	259	226	197	86.0%	BECKETT	LESS	1.85	901	\$5,652
SFH-3085W	SFH308530240510	C.O.	119	103	90	86.0%	BECKETT	TACO ECM	0.85	534	\$3,934
SFH-4100W	SFH410030240510	C.O.	140	124	108	87.0%	BECKETT	TACO ECM	1.00	668	\$4,133
SFH-4125W	SFH412530240510	C.O.	175	152	131	86.0%	BECKETT	TACO ECM	1.25	668	\$4,133
SFH-5160W	SFH516030240510	C.O.	224	195	170	86.0%	BECKETT	TACO ECM	1.60	781	\$5,257
SFH-6185W	SFH618530240510	C.O.	259	226	197	86.0%	BECKETT	TACO ECM	1.85	901	\$5,740
SFH-3085W	SFH308530220510	C.O.	119	103	90	86.0%	BECKETT	GRUNDFOS	0.85	534	\$3,934
SFH-4100W	SFH410030220510	C.O.	140	124	108	87.0%	BECKETT	GRUNDFOS	1.00	668	\$4,133
SFH-4125W	SFH412530220510	C.O.	175	152	132	86.0%	BECKETT	GRUNDFOS	1.25	668	\$4,133
SFH-5160W	SFH516030220510	C.O.	224	195	170	86.0%	BECKETT	GRUNDFOS	1.60	781	\$5,257
SFH-6185W	SFH618530220510	C.O.	259	226	197	86.0%	BECKETT	GRUNDFOS	1.85	901	\$5,740
SFH-3085W	SFH308531200510	C.P.	119	103	90	86.0%	BECKETT	LESS	0.85	534	\$4,000
SFH-4100W	SFH410031200510	C.P.	140	124	108	87.0%	BECKETT	LESS	1.00	668	\$4,198
SFH-4125W	SFH412531200510	C.P.	175	152	132	86.0%	BECKETT	LESS	1.25	668	\$4,198
SFH-5160W	SFH516031200510	C.P.	224	195	170	86.0%	BECKETT	LESS	1.60	781	\$5,344
SFH-6185W	SFH618531200510	C.P.	259	226	197	86.0%	BECKETT	LESS	1.85	901	\$5,608
SFH-3085W	SFH308531240510	C.P.	119	103	90	86.0%	BECKETT	TACO ECM	0.85	534	\$4,087
SFH-4100W	SFH410031240510	C.P.	140	124	108	87.0%	BECKETT	TACO ECM	1.00	668	\$4,285
SFH-4125W	SFH412531240510	C.P.	175	152	132	86.0%	BECKETT	TACO ECM	1.25	668	\$4,285
SFH-5160W	SFH516031240510	C.P.	224	195	170	86.0%	BECKETT	TACO ECM	1.60	781	\$5,431
SFH-6185W	SFH618531240510	C.P.	259	226	197	86.0%	BECKETT	TACO ECM	1.85	901	\$5,694

\*TYPE (C.O. - CAST OVER) (C.P. - WITH COVER PLATE) (T.C. - TANKLESS COIL)

**STARFIRE SFH - Cast Iron Chimney Vent Oil Boiler (Cont.)**

Model	Item Number	Type *	Input MBH	Htg. Cap. MBH	AHRI Net MBH	AFUE	Burner	Pump	Firing Rate GPH	Shp. Wgt. Lbs	Trade Price
SFH-3085W	SFH308531220510	C.P.	119	103	90	86.0%	BECKETT	GRUNDFOS	0.85	534	\$4,087
SFH-4100W	SFH410031220510	C.P.	140	124	108	87.0%	BECKETT	GRUNDFOS	1.00	668	\$4,285
SFH-4125W	SFH412531220510	C.P.	175	152	132	86.0%	BECKETT	GRUNDFOS	1.25	668	\$4,285
SFH-5160W	SFH516031220510	C.P.	224	195	170	86.0%	BECKETT	GRUNDFOS	1.60	781	\$5,431
SFH-6185W	SFH618531220510	C.P.	259	226	197	86.0%	BECKETT	GRUNDFOS	1.85	901	\$5,694
SFH-3085WT	SFH308532200510	T.C.	119	103	90	86.0%	BECKETT	LESS	0.85	534	\$4,186
SFH-4100WT	SFH410032200510	T.C.	140	124	108	87.0%	BECKETT	LESS	1.00	668	\$4,384
SFH-4125WT	SFH412532200510	T.C.	175	152	132	86.0%	BECKETT	LESS	1.25	668	\$4,384
SFH-5160WT	SFH516032200510	T.C.	224	195	170	86.0%	BECKETT	LESS	1.60	781	\$5,517
SFH-6185WT	SFH618532200510	T.C.	259	226	197	86.0%	BECKETT	LESS	1.85	901	\$5,898
SFH-3085WT	SFH308532240510	T.C.	119	103	90	86.0%	BECKETT	TACO ECM	0.85	534	\$4,272
SFH-4100WT	SFH410032240510	T.C.	140	124	108	87.0%	BECKETT	TACO ECM	1.00	668	\$4,471
SFH-4125WT	SFH412532240510	T.C.	175	152	132	86.0%	BECKETT	TACO ECM	1.25	668	\$4,471
SFH-5160WT	SFH516032240510	T.C.	224	195	170	86.0%	BECKETT	TACO ECM	1.60	781	\$5,605
SFH-6185WT	SFH618532240510	T.C.	259	226	197	86.0%	BECKETT	TACO ECM	1.85	901	\$5,985
SFH-3085WT	SFH308532220510	T.C.	119	103	90	86.0%	BECKETT	GRUNDFOS	0.85	534	\$4,272
SFH-4100WT	SFH410032220510	T.C.	140	124	108	87.0%	BECKETT	GRUNDFOS	1.00	668	\$4,471
SFH-4125WT	SFH412532220510	T.C.	175	152	132	86.0%	BECKETT	GRUNDFOS	1.25	668	\$4,471
SFH-5160WT	SFH516032220510	T.C.	224	195	170	86.0%	BECKETT	GRUNDFOS	1.60	781	\$5,605
SFH-6185WT	SFH618532220510	T.C.	259	226	197	86.0%	BECKETT	GRUNDFOS	1.85	901	\$5,985
SFH-3085W	SFH308520200510	C.O.	140	103	90	86.0%	LESS	LESS	1.00	534	\$2,844
SFH-4125W	SFH412520200510	C.O.	175	175	132	86.0%	LESS	LESS	1.45	668	\$3,043
SFH-5160W	SFH516020200510	C.O.	224	195	170	86.0%	LESS	LESS	1.85	781	\$4,167
SFH-6185W	SFH618520200510	C.O.	259	226	197	86.0%	LESS	LESS	2.10	901	\$4,649
SFH-3085W	SFH308520240510	C.O.	140	103	90	86.0%	LESS	TACO ECM	1.00	534	\$2,931
SFH-4125W	SFH412520240510	C.O.	175	175	132	86.0%	LESS	TACO ECM	1.45	668	\$3,129
SFH-5160W	SFH516020240510	C.O.	224	195	170	86.0%	LESS	TACO ECM	1.85	781	\$4,254
SFH-6185W	SFH618520240510	C.O.	259	226	197	86.0%	LESS	TACO ECM	2.10	901	\$4,736
SFH-3085W	SFH308520220510	C.O.	140	103	103	86.0%	LESS	GRUNDFOS	1.00	534	\$2,931
SFH-4125W	SFH412520220510	C.O.	175	175	132	86.0%	LESS	GRUNDFOS	1.45	668	\$3,129
SFH-5160W	SFH516020220510	C.O.	224	195	170	86.0%	LESS	GRUNDFOS	1.85	781	\$4,254
SFH-6185W	SFH618520220510	C.O.	259	226	197	86.0%	LESS	GRUNDFOS	2.10	901	\$4,736

**\*TYPE (C.O. - CAST OVER) (C.P. - WITH COVER PLATE) (T.C. - TANKLESS COIL)**

STARFIRE SFH - Cast Iron Chimney Vent Oil Boiler (Cont.)											
Model	Item Number	Type *	Input MBH	Htg. Cap. MBH	AHRI Net MBH	AFUE	Burner	Pump	Firing Rate GPH	Shp. Wgt. Lbs	Trade Price
SFH-3085W	SFH308521200510	C.P.	140	103	90	86.0%	LESS	LESS	1.00	534	\$2,996
SFH-4125W	SFH412521200510	C.P.	175	175	132	86.0%	LESS	LESS	1.45	668	\$3,195
SFH-5160W	SFH516021200510	C.P.	224	195	170	86.0%	LESS	LESS	1.85	781	\$4,340
SFH-6185W	SFH618521200510	C.P.	259	226	197	86.0%	LESS	LESS	2.10	901	\$4,604
SFH-3085W	SFH308521240510	C.P.	140	103	90	86.0%	LESS	TACO ECM	1.00	534	\$3,084
SFH-4125W	SFH412521240510	C.P.	175	175	132	86.0%	LESS	TACO ECM	1.45	668	\$3,281
SFH-5160W	SFH516021240510	C.P.	224	195	170	86.0%	LESS	TACO ECM	1.85	781	\$4,427
SFH-6185W	SFH618521240510	C.P.	259	226	197	86.0%	LESS	TACO ECM	2.10	901	\$4,690
SFH-3085W	SFH308521220510	C.P.	140	103	90	86.0%	LESS	GRUNDFOS	1.00	534	\$3,084
SFH-4125W	SFH412521220510	C.P.	175	175	132	86.0%	LESS	GRUNDFOS	1.45	668	\$3,281
SFH-5160W	SFH516021220510	C.P.	224	195	170	86.0%	LESS	GRUNDFOS	1.85	781	\$4,427
SFH-6185W	SFH618521220510	C.P.	259	226	197	86.0%	LESS	GRUNDFOS	2.10	901	\$4,690
SFH-3085WT	SFH308522200510	T.C.	140	103	90	86.0%	LESS	LESS	1.00	534	\$3,182
SFH-4125WT	SFH412522200510	T.C.	175	175	132	86.0%	LESS	LESS	1.45	668	\$3,380
SFH-5160WT	SFH516022200510	T.C.	224	195	170	86.0%	LESS	LESS	1.85	781	\$4,514
SFH-6185WT	SFH618522200510	T.C.	259	226	197	86.0%	LESS	LESS	2.10	901	\$4,894
SFH-3085WT	SFH308522240510	T.C.	140	103	90	86.0%	LESS	TACO ECM	1.00	534	\$3,269
SFH-4125WT	SFH412522240510	T.C.	175	175	132	86.0%	LESS	TACO ECM	1.45	668	\$3,467
SFH-5160WT	SFH516022240510	T.C.	224	195	170	86.0%	LESS	TACO ECM	1.85	781	\$4,601
SFH-6185WT	SFH618522240510	T.C.	259	226	197	86.0%	LESS	TACO ECM	2.10	901	\$4,982
SFH-3085WT	SFH308522220510	T.C.	140	103	90	86.0%	LESS	GRUNDFOS	1.00	534	\$3,269
SFH-4125WT	SFH412522220510	T.C.	175	175	132	86.0%	LESS	GRUNDFOS	1.45	668	\$3,467
SFH-5160WT	SFH516022220510	T.C.	224	195	170	86.0%	LESS	GRUNDFOS	1.85	781	\$4,601
SFH-6185WT	SFH618522220510	T.C.	259	226	197	86.0%	LESS	GRUNDFOS	2.10	901	\$4,982

\*TYPE (C.O. - CAST OVER) (C.P. - WITH COVER PLATE) (T.C. - TANKLESS COIL)

STARFIRE SFH (Use Parts Multiplier for All of the Following)			
Model	Item Number	Description	Trade Price
SFH-4125	550004116	4100/4125 BECKETT RERATE KIT	\$83
SFH-3085	550004100	SFH-3085 BECKETT BURNER IN A BOX KIT	\$1,004
SFH-4125	550004101	SFH-4100/4125 BECKETT BURNER IN A BOX KIT	\$1,004
SFH-5160	550004102	SFH-5160 BECKETT BURNER IN A BOX KIT	\$1,004
SFH-6185	550004103	SFH-6185 BECKETT BURNER IN A BOX KIT	\$1,004
SFH	550004104	SFH-3085/4100/4125/5160 RIELLO40F5 BURNER BOX KIT	\$1,204
SFH	550004105	SFH-6185 RIELLO 40F10 BURNER IN A BOX KIT	\$1,596
SFH	550004106	SFH-3085/4100/4125 CARLIN EZ1-HP BURNER IN A BOX KIT	\$1,004
SFH	550004107	SFH-5160/6185 CARLIN EZ2-HP BURNER IN A BOX KIT	\$1,004

## SBO Cast Iron Steam Oil Boilers

- MBH Input 119 - 210 (CH)
- Up to 85.6% AFUE
- Dependable Cast Iron Heat Exchanger
- Cast Iron Swing out Burner Door and large flueways allow for easy cleaning and servicing
- Honeywell Pressure Control, Boiler Water Level Gauge Glass, and Steam Pressure Gauge
- Electronic Low Water Cutoff (LWCO)
- Atmospheric Chimney Vent Boiler



General Information (See IOM for Complete Instructions)				
Model	SBO-3085	SBO-3105	SBO-4125	SBO-4150
Return/Supply Tappings	1 1/4" Return NPT, 2" Supply NPT			
Oil	3/8" O.D. Copper (runs 50' or less, 1/2" O.D. Copper (runs over 50')			
Electrical	120 Volts AC, 60 hertz, 1 phase, less than 12 amps (15 amp circuit recommended)			
Water Content (Gallons)	12	12	14.87	14.87
Dimensions	A-Height	35"	35"	35"
	B-Width	22 1/8"	22 1/8"	22 1/8"
	C-Depth	15 3/4"	15 3/4"	19 3/4"

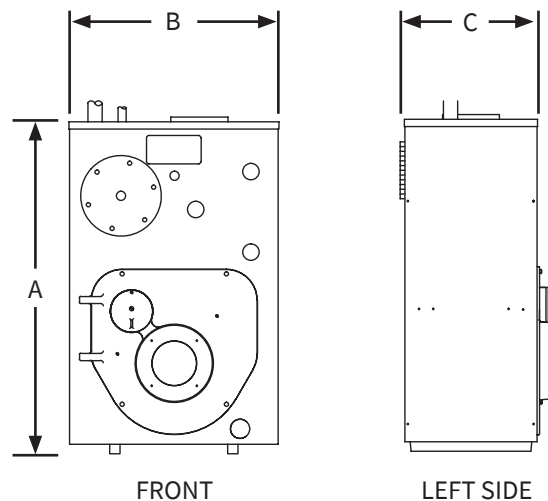

**SBO - Cast Iron Steam Oil Boiler Less Burner**

Model	Item Number	Type	Input MBH	Htg. Cap. MBH	AHRI Net MBH	AHRI Net Sq. Ft.	AFUE	Burner	Firing Rate GPH	Shp. Wgt. lbs	Trade Price
SBO-3105	SBO310521700110	LESS	147	127	95	396	85.0%	LESS	1.05	538	\$3,522
SBO-4150	SBO415021700110	LESS	210	180	135	563	85.0%	LESS	1.50	650	\$4,139

**SBO (Use Equipment Multiplier for All of the Following)**

Model	Item Number	Description	Trade Price
SBO	550004158U	TANKLESS COIL KIT WITH CONTROL	\$484
SBO-3105	550004153U	SBO-3105 BECKETT BURNER IN A BOX KIT	\$801
SBO-4150	550004154U	SBO-4150 BECKETT BURNER IN A BOX KIT	\$801

**Please Note: Oil Fired Steam Boilers are sold less burner. Please add burner in a box kit to your order.**

**Tankless Coil Kits are sold separately.**

**SBO (Use Parts Multiplier for All of the Following)**

Model	Item Number	Description	Trade Price
SBO	550004155	3085/3105 BECKETT RERATE KIT	\$136
SBO	550004156	4125/4150 BECKETT RERATE KIT	\$136

## H2O GL Single Coil Glass Lined Indirect Water Heaters

- 31 - 106 Gallon Capacities
- Easy to Install
- Low Pressure Drop
- Magnesium Anode Rod Corrosion Protection
- Enameled Coated Steel Tank and Coil
- Minimal Standby Losses
- Flexible Scratch Resistant Jacket
- Aquastat Sensor Well
- Temperature Pressure Relief Valve



(H2O40GL Model Shown)

General Information (See IOM for Complete Instructions)					
Maximum Working Pressure: 150 psi for all Capacities					
Model	Piping Connections NPT		Dimensions		
	Domestic Water In/Out	Boiler Water In/Out	Diameter	Height	Weight
H2O 30 GL	1"	1"	24"	33"	119 lbs
H2O 40 GL	1"	1"	24"	45"	180 lbs
H2O 50 GL	1"	1"	24"	51"	200 lbs
H2O 80 GL	1"	1"	30"	48"	243 lbs
H2O 105 GL	1"	1"	30"	62"	393 lbs

<b>H2O GL - Single Coil Glass Lined Indirect Water Heaters</b>								
<b>Model</b>	<b>Item Number</b>	<b>Storage Capacity gal</b>	<b>Type</b>	<b>Max. First Hour Rating gal/hr @</b>	<b>Continuous Rating gal/hr @</b>	<b>Boiler Output Req. BTU/hr</b>	<b>Shp. Wgt. lbs</b>	<b>Trade Price</b>
H2O 30 GL	H2OIG30UB	31	GLASS LINED	155	124	100,000	119	\$1,248
H2O 40 GL	H2OIG40UB	42	GLASS LINED	256	220	120,000	180	\$1,285
H2O 50 GL	H2OIG50UB	53	GLASS LINED	310	268	140,000	200	\$1,463
H2O 80 GL	H2OIG80UB	79	GLASS LINED	346	281	180,000	243	\$2,030
H2O 105 GL	H2OIG105UB	106	GLASS LINED	440	345	220,000	393	\$3,175

<b>H2O GL (Use Parts Multiplier for All of the Following)</b>			
<b>Model</b>	<b>Item Number</b>	<b>Description</b>	<b>Trade Price</b>
30-105 GAL.	240010926	T & P VALVE 3/4, 100XL-8	\$50
30-105 GAL.	AQ-020.01	AQUASTAT WELL	\$35
30-105 GAL.	240009521	AQUASTAT L4080B1352	\$141
30-50 GAL.	240012211	PLASTIC TOP CAP	\$28
80-105 GAL.	240012239	PLASTIC TOP CAP	\$39
40-105 GAL.	240012212	PLASTIC FRONT CAP	\$8
30 GAL.	550003640	ANODE KIT MAGNESIUM (INCLUDES ANODE, GASKET & BUSHING)	\$37
40-50 GAL.	550003505	ANODE KIT MAGNESIUM (INCLUDES ANODE, GASKET & BUSHING)	\$37
80-105 GAL.	550003527	ANODE KIT MAGNESIUM (INCLUDES ANODE, GASKET & BUSHING)	\$71
30 GAL.	550003693	ANODE KIT ALUMINUM (INCLUDES ANODE, GASKET & BUSHING)	\$36
40-50 GAL.	550003694	ANODE KIT ALUMINUM (INCLUDES ANODE, GASKET & BUSHING)	\$37
80-105 GAL.	550003695	ANODE KIT ALUMINUM (INCLUDES ANODE, GASKET & BUSHING)	\$71
30-50 GAL.	240012250	FLANGE CAP	\$39
80-105 GAL.	240012251	FLANGE CAP	\$14
30-50 GAL.	240012210	FLANGE GASKET	\$2
80-105 GAL.	240012238	FLANGE GASKET	\$4
40-50 GAL.	550003510	HARDWARE KIT (INCLUDES BOLTS & NUTS FOR FLANGE CAP)	\$4
80-105 GAL.	550003525	HARDWARE KIT (INCLUDES BOLTS & NUTS FOR FLANGE CAP)	\$4
H2O 30 GL	240012474	OUTSIDE TANK COVER	\$104
H2O 40 GL	240012329	OUTSIDE TANK COVER	\$105
H2O 50 GL	240012330	OUTSIDE TANK COVER	\$112
H2O 80 GL	240012331	OUTSIDE TANK COVER	\$123
H2O 105 GL	240012332	OUTSIDE TANK COVER	\$137
30-50 GAL.	240012483	TEMPERATURE GAUGE	\$15
80-105 GAL.	240012484	TEMPERATURE GAUGE	\$23

## H2O SC Single Coil Stainless Steel Indirect Water Heaters

- 30 - 115 Gallon Capacities
- 316L Stainless Steel Construction
- Top Connections (For Easy Install)
- Stainless Steel Dip Tube
- Thermoplastic Jacket
- Low Pressure Drop
- T & P Valve, Stainless Steel Aquastat Well and Drain Valve
- 2.25" EPS Insulation
- Large Diameter, Smooth Coil Heat Exchangers - Prevent Buildup
- Honeywell L4080B Aquastat



**H2O**

**I**

Indirect

**30**

Capacity:  
 30=30 gals  
 40=40 gals  
 50=50 gals  
 60=60 gals  
 80=80 gals  
 85=87 gals  
 115=115 gals

**L**

Type:  
 L=Lowboy  
 HO=High Output  
 HOC=High Output  
 Commercial  
 XHO=Extra High  
 Output

**UB**

UB=Utica

General Information (See IOM for Complete Instructions)					
Maximum Working Pressure: 150 psi for all Capacities					
Model	Piping Connections NPT		Dimensions		
	Domestic Water In/Out	Boiler Water In/Out	Diameter	Height	Weight
H2OI30UB	3/4"	1"	23 1/2"	34"	85 lbs
H2OI40UB	3/4"	1"	23 1/2"	44"	100 lbs
H2OI40LUB	3/4"	1"	28"	36"	100 lbs
H2OI50UB	3/4"	1"	23 1/2"	54"	110 lbs
H2OI60UB	3/4"	1"	23 1/2"	62"	125 lbs
H2OI60LUB	3/4"	1"	28"	46"	120 lbs
H2OI80UB	1"	1"	28"	56"	140 lbs
H2OI115UB	1"	1"	28"	74"	175 lbs
High Output Units					
H2OI60HOUB	1"	1"	23 1/2"	62"	145 lbs
H2OI80HOUB	1"	1"	28"	56"	155 lbs
H2OI80HOCUB	1 1/2"	1 1/4"	28"	56"	155 lbs
H2OI115HOUB	1"	1"	28"	74"	190 lbs
H2OI115HOCUB	1 1/2"	1 1/4"	28"	74"	190 lbs
Extra High Output Units 85XHO and 115XHO					
H2OI85XHOCUB	1 1/2"	1 1/2"	28"	64"	215 lbs
H2OI115XHOCUB	1 1/2"	1 1/2"	28"	74"	240 lbs



**H2O SC - Single Coil Stainless Steel Indirect Water Heaters**

Item Number	Storage Capacity gal	Type	Max. First Hour Rating gal/hr @		Boiler Output Req. BTU/hr	Shp. Wgt. lbs	Trade Price
			140° F	115° F			
H2OI30UB	30	STANDARD	202	269	131,250	85	\$1,690
H2OI40UB	40	STANDARD	221	292	138,670	100	\$1,738
H2OI40LUB	42	LOWBOY	212	251	132,000	100	\$1,851
H2OI50UB	50	STANDARD	223	291	133,280	110	\$2,098
H2OI60UB	60	STANDARD	262	342	155,700	125	\$2,508
H2OI60LUB	60	LOWBOY	239	310	138,570	120	\$2,582
H2OI80UB	80	STANDARD	271	248	149,390	140	\$2,782
H2OI115UB	115	STANDARD	324	409	165,750	175	\$4,128
H2OI60HOUB	60	HIGH OUTPUT	406	541	263,600	145	\$2,707
H2OI80HOUB	80	HIGH OUTPUT	418	551	259,640	155	\$3,761
H2OI80HOCUB	80	HIGH OUTPUT COMMERCIAL	442	584	227,070	155	\$4,059
H2OI115HOUB	115	HIGH OUTPUT	467	607	273,100	190	\$4,530
H2OI115HOCUB	115	HIGH OUTPUT COMMERCIAL	479	623	281,300	190	\$5,385
H2OI85XHOCUB	87	EXTRA HIGH OUTPUT	738	992	495,000	215	\$5,055
H2OI115XHOCUB	115	EXTRA HIGH OUTPUT	763	1017	495,000	240	\$6,001

## H2O DC Single & Dual Coil Stainless Steel Solar Water Heaters

- 60 - 115 Gallon Capacities
- 316L Stainless Steel Construction
- Top Connections (For Easy Install)
- Stainless Steel Dip Tube
- Thermoplastic Jacket
- Low Pressure Drop
- T & P Valve, Stainless Steel Aquastat Well and Drain Valve
- 2.25" EPS Insulation
- Large Diameter, Smooth Coil Heat Exchangers - Prevent Buildup
- Honeywell L4080B Aquastat



**H2O**

**I**

Indirect

**60**

Capacity:  
 60=60 gals  
 80=80 gals  
 115=115 gals

**D**

D=Dual Coil

**E**

E=Electric Backup  
 (3500 Watts)

**UB**

UB=Utica

General Information (See IOM for Complete Instructions)				
Maximum Working Pressure: 150 psi for all Capacities				
Model	Piping Connections NPT	Dimensions		
		Diameter	Height	Weight
H2O160EUB	1"	23"	62"	135 lbs
H2O180EUB	1"	28"	56"	145 lbs
H2O115EUB	1"	28"	74"	180 lbs
H2O160DUB	1"	23"	62"	165 lbs
H2O180DUB	1"	28"	56"	175 lbs
H2O115DUB	1"	28"	74"	205 lbs
H2O160DEUB	1"	23"	62"	175 lbs
H2O180DEUB	1"	28"	56"	185 lbs
H2O115DEUB	1"	28"	74"	215 lbs

**H2O DC - Single & Dual Coil Stainless Steel Solar Water Heaters**

Item Number	Storage Capacity gal	Type	Recovery Rate gal/hr		Ship Wgt. lbs	Trade Price
			Top Coil	Bottom Coil		
H2OI60EUB	60	ELECTRIC BACK-UP	N/A	214	135	\$3,523
H2OI80EUB	80	ELECTRIC BACK-UP	N/A	214	145	\$3,940
H2OI115EUB	115	ELECTRIC BACK-UP	N/A	214	180	\$5,462
H2OI60DUB	60	INDIRECT	185	214	165	\$3,329
H2OI80DUB	80	INDIRECT	180	214	175	\$3,791
H2OI115DUB	115	INDIRECT	190	214	205	\$4,855
H2OI60DEUB	60	ELECTRIC BACK-UP	185	214	175	\$4,111
H2OI80DEUB	80	ELECTRIC BACK-UP	180	214	185	\$4,645
H2OI115DEUB	115	ELECTRIC BACK-UP	190	214	215	\$5,828

## H2O BT Stainless Steel Buffer Tanks, w/ and w/o Coil

- 22 - 115 Gallon Capacities
- 316L Stainless Steel Construction
- Top Connections (For Easy Installation)
- Thermoplastic Jacket
- Low Pressure Drop
- T & P Valve, Stainless Steel Aquastat Well and Drain Valve
- 2.25" EPS Insulation



**H2O**

**BT**  
 BT=Buffer Tank

**40**  
 Capacity:  
 22=22 gals  
 40=40 gals  
 60=60 gals  
 80=80 gals

**114**  
 Connection:  
 114=1 1/4" NPT  
 112=1 1/2" NPT  
 2=2" NPT

**WC**  
 WC=With Coil

**UB**  
 UB=Utica

General Information (See IOM for Complete Instructions)				
Maximum Working Pressure: 150 psi for all Capacities				
Model	Piping Connections NPT	Dimensions		
		Diameter	Height	Weight
H2OBT22114UB	1 1/4"	22 1/2"	24 1/2"	35 lbs
H2OBT40114UB	1 1/4"	22 1/2"	42"	87 lbs
H2OBT40112UB	1 1/2"	22 1/2"	42"	87 lbs
H2OBT402UB	2"	22 1/2"	42"	87 lbs
H2OBT60114UB	1 1/4"	26 1/2"	44"	115 lbs
H2OBT60112UB	1 1/2"	26 1/2"	44"	115 lbs
H2OBT602UB	2"	26 1/2"	44"	115 lbs
H2OBT80114UB	1 1/4"	26 1/2"	54"	125 lbs
H2OBT80112UB	1 1/2"	26 1/2"	54"	125 lbs
H2OBT802UB	2"	26 1/2"	54"	125 lbs
H2OBT115114UB	1 1/4"	26 1/2"	72"	160 lbs
H2OBT115112UB	1 1/2"	26 1/2"	72"	160 lbs
H2OBT1152UB	2"	26 1/2"	72"	160 lbs
H2OBT40114WCUB	1 1/4"	22 1/2"	42"	97 lbs
H2OBT40112WCUB	1 1/2"	22 1/2"	42"	97 lbs
H2OBT402WCUB	2"	22 1/2"	42"	97 lbs
H2OBT60114WCUB	1 1/4"	26 1/2"	44"	125 lbs
H2OBT60112WCUB	1 1/2"	26 1/2"	44"	125 lbs
H2OBT602WCUB	2"	26 1/2"	44"	125 lbs
H2OBT80114WCUB	1 1/4"	26 1/2"	54"	135 lbs
H2OBT80112WCUB	1 1/2"	26 1/2"	54"	135 lbs
H2OBT802WCUB	2"	26 1/2"	54"	135 lbs
H2OBT115114WCUB	1 1/4"	26 1/2"	72"	170 lbs
H2OBT115112WCUB	1 1/2"	26 1/2"	72"	170 lbs
H2OBT1152WCUB	2"	26 1/2"	72"	170 lbs

**H2O BT - Stainless Steel Buffer Tanks (With & Without Coil)**

<b>Item Number</b>	<b>Storage Capacity gal</b>	<b>Type</b>	<b>Shp. Wgt. lbs</b>	<b>Trade Price</b>
H2OBT22114UB	22	HYDRONIC BUFFER TANK	35	\$1,502
H2OBT40114UB	40	HYDRONIC BUFFER TANK	87	\$2,629
H2OBT40112UB	40	HYDRONIC BUFFER TANK	87	\$2,629
H2OBT402UB	40	HYDRONIC BUFFER TANK	87	\$2,629
H2OBT60114UB	60	HYDRONIC BUFFER TANK	115	\$3,130
H2OBT60112UB	60	HYDRONIC BUFFER TANK	115	\$3,130
H2OBT602UB	60	HYDRONIC BUFFER TANK	115	\$3,130
H2OBT80114UB	80	HYDRONIC BUFFER TANK	125	\$3,457
H2OBT80112UB	80	HYDRONIC BUFFER TANK	125	\$3,457
H2OBT802UB	80	HYDRONIC BUFFER TANK	125	\$3,457
H2OBT115114UB	115	HYDRONIC BUFFER TANK	160	\$4,302
H2OBT115112UB	115	HYDRONIC BUFFER TANK	160	\$4,302
H2OBT1152UB	115	HYDRONIC BUFFER TANK	160	\$4,302
H2OBT40114WCUB	40	HYDRONIC BUFFER TANKS (WITH COIL)	97	\$3,369
H2OBT40112WCUB	40	HYDRONIC BUFFER TANKS (WITH COIL)	97	\$3,370
H2OBT402WCUB	40	HYDRONIC BUFFER TANKS (WITH COIL)	97	\$3,369
H2OBT60114WCUB	60	HYDRONIC BUFFER TANKS (WITH COIL)	125	\$3,920
H2OBT60112WCUB	60	HYDRONIC BUFFER TANKS (WITH COIL)	125	\$3,920
H2OBT602WCUB	60	HYDRONIC BUFFER TANKS (WITH COIL)	125	\$3,920
H2OBT80114WCUB	80	HYDRONIC BUFFER TANKS (WITH COIL)	135	\$4,273
H2OBT80112WCUB	80	HYDRONIC BUFFER TANKS (WITH COIL)	135	\$4,273
H2OBT802WCUB	80	HYDRONIC BUFFER TANKS (WITH COIL)	135	\$4,273
H2OBT115114WCUB	115	HYDRONIC BUFFER TANKS (WITH COIL)	170	\$5,204
H2OBT115112WCUB	115	HYDRONIC BUFFER TANKS (WITH COIL)	170	\$5,204
H2OBT1152WCUB	115	HYDRONIC BUFFER TANKS (WITH COIL)	170	\$5,204

## H2O ST Stainless Steel Storage Tanks

- 30 - 115 Gallon Capacities
- 316L Stainless Steel Construction
- Top Connections (For Easy Installation)
- Stainless Steel Dip Tube -Thermoplastic Jacket
- Low Pressure Drop
- T & P Valve, Stainless Steel Aquastat Well and Drain Valve
- 2.25” EPS Insulation
- Honeywell L4080B



**H2O**

**ST**

ST=Storage

**30**

Capacity:  
 30=30 gals  
 40=40 gals  
 60=60 gals  
 80=80 gals  
 115=115 gals

**L**

Type:  
 L=Lowboy  
 C=Commercial

**UB**

UB=Utica

General Information (See IOM for Complete Instructions)					
Maximum Working Pressure: 150 psi for all Capacities					
Model	Piping Connections NPT		Dimensions		
	Return/Supply	Heat Source Pressure	Diameter	Height	Weight
H2OST30UB	1”	1”	23 1/2”	34”	75 lbs
H2OST40UB	1”	1”	23 1/2”	44”	90 lbs
H2OST60UB	1”	1”	23 1/2”	62”	115 lbs
H2OST60LUB	1”	1”	23 1/2”	46”	110 lbs
H2OST80UB	1”	1”	28”	56”	140 lbs
H2OST115UB	1”	1”	28”	74”	175 lbs
H2OST80CUB	1 1/2”	1”	28”	56”	140 lbs
H2OST115CUB	1 1/2”	1”	28”	74”	175 lbs

<b>H2O ST - Stainless Steel Storage Tanks (No Coil)</b>				
<b>Item Number</b>	<b>Storage Capacity gal</b>	<b>Type</b>	<b>Shp. Wgt. lbs</b>	<b>Trade Price</b>
H2OST30UB	30	STANDARD STORAGE TANK	75	\$1,499
H2OST40UB	40	STANDARD STORAGE TANK	90	\$1,549
H2OST60UB	60	STANDARD STORAGE TANK	115	\$2,259
H2OST60LUB	60	LOWBOY STORAGE TANK	110	\$2,334
H2OST80UB	80	STANDARD STORAGE TANK	140	\$2,568
H2OST80CUB	80	COMMERCIAL STORAGE TANK	175	\$3,699
H2OST115UB	115	STANDARD STORAGE TANK	140	\$2,825
H2OST115CUB	115	COMMERCIAL STORAGE TANK	175	\$3,957

## TERMS & CONDITIONS OF SALE - GENERAL TERMS

**PRICES & SPECIFICATIONS:** All pricing and specifications subject to change without notice. The prices herein supersede all prior quotations.

**ORDERS:** Orders will be accepted based on prices in effect at the time the order is received. No order or contract will become an obligation on our part until accepted by the General Sales Department. ECR International shall not be liable for any delay or failure in the delivery or shipment of goods due to any cause or causes beyond its control.

**TAXES:** Add to the prices and terms quoted any manufacturers' or sales tax payable on the transaction under any effective statute.

---

### SHIPMENTS

**TRUCKLOADS:** \$50,000 Net Order Value - Freight Prepaid. Indirect Water Heaters and Commercial Boiler lines can be added to any residential order for freight purposes. Authorized Distributors can combine Argo, Airco, Dunkirk, EMI, Olsen, Pennco, Utica Boilers and Utica Heating on one purchase order to earn free freight.

Stop off charges of \$150 will apply to stop off locations within 100 miles of the final destination. Please call for pricing for stop off special handling for a location further than 100 miles or for special handling pricing for services such as lift gate, unloading assistance, etc.

**LESS THAN TRUCKLOAD SHIPMENT: F.O.B. ECR INTERNATIONAL - FACTORY OR WAREHOUSE**

**See Shipping and Delivery Policy for full details.**

---

### SALES ORDER INFORMATION CHECK LIST

The following information must be included on equipment or parts orders to insure proper shipment & invoicing:

- |  |  |
|--|--|
| 1) Purchase Order Number                       | 7) Pricing   |
| 2) Bill to Address                             | 8) Product Description (Model, Size, etc.)   |
| 3) Ship to Address                             | 9) Fuel Type (Oil, Natural Gas, Propane)   |
| 4) Method of Shipment (trailer load, UPS)      | 10) Electrical (Operating Voltage, Cycles, Phases, etc.)   |
| 5) Requested Ship Date                         | 11) Non-Standard Equipment (Indicate "Optional" when substituted for standard equipment at extra cost listed. Indicate added to standard equipment.) |
| 6) Special Instructions ("Carrier to call...") | 12) Kits or Parts (Orders for kits or parts must indicate equipment size and series.)  |

Send orders to:

**E-mail: [ecrorderentry@ecrinternational.com](mailto:ecrorderentry@ecrinternational.com)**

**Fax: (315) 724-9319**

Please note the following Remit to Address:

**ECR International, Inc.**

**P.O. Box 8000 Department 039**

**Buffalo, NY 14267**



## SHIPPING AND DELIVERY POLICY

Order type/value*	Freight Charge*
All UPS, Fed Ex, DHL etc. shipments	Actual Freight Cost Apply
\$0 - \$5,000	Actual Freight Cost Apply
\$5,001 - \$15,000	\$300
\$15,001 - \$49,999	\$250
\$50,000+**	FFA

\*The above freight terms apply to single purchase orders or combined purchases orders from one company with one stop totaling the above reference tiers. Additional stops will incur additional charges. Pooling from multiple companies is not allowed under this freight program.

\*\*Orders of \$50K or more from one company with multiple stops will incur a \$150 stop-off charge per stop after the first. Each stop-off location must be within 100 miles or additional charges will apply.

Because of the nature of packaging and shipping constraints EMI, Enviroair and Retroaire do not qualify for this program unless prior approval is obtained.

Except for FFA qualifying orders, the above US shipping rates apply to shipments east of the Mississippi River. If shipments are outside of that area actual freight rates will apply.

These rates apply to destinations where no special delivery requirements are needed. Additional charges will apply when special handling and delivery is incurred. Pre-shipment notification of any special shipping or handling provisions is required. Unless otherwise noted all products will be shipped FOB Shipping Point and transfer of ownership and responsibility is assumed by the customer for all loss or damage. ECR International will not be held liable for any damage, loss or costs which occur due to shipping delay. ECR retains the right to change or alter this program without notice and without penalty

As a reminder, orders of boilers, furnaces, air-conditioning and controls can be combined to achieve freight tiers.

If you have any questions, please contact your ECR representative or ECR Regional Sales Manager.

## U.S. DISTRIBUTOR - RETURN MATERIAL POLICY (RMA)

**Prior Approval Required** - All returns for exchange, credit, repair service or warranty claim must be approved by ECR International and require an RMA number prior to return of the material. A request must be completed via the online web portal. Please log on to [www.ecrcustomerportal.com](http://www.ecrcustomerportal.com) to complete your request for return. If you do not already have access to the customer web portal, please contact ECR International Customer Service at 1-800-325-5479 to be set-up.

**Eligibility** – An RMA Request must be received within 60 days from the date of invoice for returns of New & Unused product in original packaging. A restocking fee of 15% will be charged for all new and unused returns that are approved for return. Special Order Products (items not offered as standard in ECR International trade price book) are not eligible for return as new and unused product. Request for Warranty Returns must be made within the period covered by the warranty and must fall under the terms and conditions specified in the warranty.

**Repair Service** - Request for repair or rework of product damaged by customer is classified as Repair Service. Repair Service is billed at \$75.00 per hour for labor and net price for parts used in repair/rework. ECR International's Return Material (RM) department will evaluate the items returned for repair service. The customer will receive an estimate for the dollar amount, determined by ECR International's RM department, required to complete the repairs requested. A Purchase Order (PO) from the customer for that amount will be required before any work is performed.

**RMA Expiration Parts** - Once the RMA number is issued, the product must be returned within 60 days of the RMA date, or the RMA will be canceled. Products approved for return that are received after 60 days from the RMA date will not be accepted.

**Shipping & Packaging** - All returns must have a valid RMA number clearly displayed on the exterior of the package or the package will not be accepted. All returns of new and unused product must be in the original packaging. All returns must be shipped prepaid by the customer unless otherwise directed by ECR as indicated on the RMA Verification. Ship all approved return material to the facility indicated on the approved RMA Request by the date indicated.

**Replacement Product** - If replacement product is desired it must be indicated on the RMA Request. A PO# is required for the replacement shipment and must be indicated on the RMA Request. All replacement products will be invoiced at the time of shipment. ECR will pay the ground freight for all warranty replacements.

**Application of Credit** - Credit for returned product will be applied to the customer's account (less restocking fees for New and Unused returns) only after confirmation of receipt by ECR and inspection of the product. Issuance of a credit for a partial return of product does not relieve the customer from the obligation to remit payment for the merchandise not returned in accordance with the payment terms referenced on the customer's invoice(s). Customer will have the option to have any product that is denied for credit returned at their expense.

**Returning Installed Finished Goods** (Complete boilers, furnaces, A/C units etc.)

- Equipment that is already installed should be repaired not replaced. Exceptions: leaking cast iron boilers in their first year or leaking water tanks. Leaking drain valves on water tanks are replaceable, make sure the leak is not on the valve. Tanks returned with the only leak being on the valve will be denied.
- Cast iron blocks (not complete boilers) older than one year and Indirect tanks that are leaking do not require prior approval. Simply type "Leaking" into the Authorization field and it will be accepted. Complete Cast iron boilers within their first year will still require prior authorization for full boiler replacement.
- Water leaks on copper and condensing boilers are repairable and will require prior authorization for any reason for removal.
- To guarantee credit, if a situation arises where equipment does need to be replaced, **prior authorization** from ECR is required. This will ensure that ECR has visibility to the problem and has had an opportunity to correct it prior to removal. *All equipment considered for removal should first be brought to the attention of Technical Support at 1-800-253-7900.*
- If approved, an authorization number will be given that will need to be entered in the RMA on the Customer Portal.
- For equipment that is removed from service without prior authorization by ECR, contact Customer Service. They will evaluate the circumstance and can issue a conditional RMA. The equipment will be tested in our lab to determine if removal was warranted and if credit will be given.

**RMA Expiration Equipment** - Once the RMA number is issued, the product must be returned within 30 days of the RMA date, or the RMA will be canceled. Products approved for return that are received after 30 days from the RMA date will not be accepted.

**This page is intentionally left blank.**



*There are some things you can always depend on...*

[www.utica boilers.com](http://www.utica boilers.com)



2201 Dwyer Avenue, Utica, NY 13501  
Tel. 800 325 5479  
[www.ecrinternational.com](http://www.ecrinternational.com)

All specifications subject to change without notice.  
©2021 ECR International, Inc.  
PN 240005093 REV. O [07/21/2021]