



**UCS 240 Wall-Hung
and UCS 380 Floor
Mounted Condensing
Boilers**

240:
95% AFUE
Optional Floor Base Kit
Residential and Light
Commercial
380:
95% Thermal Efficiency
Commercial Installations



**MAC Wall-Hung
Stainless Steel
Modulating
Condensing Boiler**

95% AFUE
Available in 125 & 150
MBH
Heating Only or Combi



**MGB II / MGC Series
Gas-Fired Water Boiler**

Up to 83.9% AFUE
Available in 50 to 299
MBH



**H2O Stainless Steel
Indirect Water Heater**

Easy to Install
All Connections on Top
Limited Lifetime
Warranty (Residential)

Customer Service Technical Support

Phone: 800-325-5479
Fax: 315-724-9319/ 866-432-7329

Corporate Sales

Phone: 877-386-5475
Fax: 716-366-4670

Literature

literature@ecrinternational.com



ECR International: 2201 Dwyer Avenue, Utica, NY 13501
Tel. 315 797 1310 or 800 325 5479 Fax. 315 724 9319 www.ecrinternational.com

P/N 240005093 - Rev. E 2/18

TABLE OF CONTENTS

Terms & RMA Policy	3-4
Gas Condensing Boilers	
SSC Stainless Steel Wall Hung Modulating Condensing Boiler	5-7
SSV Stainless Steel Wall Hung Modulating Condensing Boiler	8-10
UCS-240 Stainless Steel Modulating Condensing Boiler	11-13
UCS-380 Stainless Steel Floor Standing Modulating Condensing Boiler	14-16
MAC Stainless Steel Wall Hung Modulating Condensing Combi Boiler	17-19
97GB Stainless Steel Floor/Wall Modulating Condensing Boiler	20-21
UB90-100 Series IV Cast Aluminum Condensing Boiler	22-24
Gas Modulating Space Heating Only & Combi Boilers	
CuB Copper Wall Hung Modulating Boiler	25-26
Gas Cast Iron Boilers	
SVB II Series	27-30
MGB II & MGC Series	31-34
PEG Series E	35-36
JE Steam	37-39
Oil Cast Iron Boilers	
TriFire TRB	40-44
SFH IV	45-50
SFE IV	51-52
BC Series II	53-54
Indirect Hot Water Heaters	
H2O Single Coil Stainless Steel Indirect Hot Water Heater	55-56
H2O Dual Coil Stainless Steel Indirect Hot Water Heater	57-58
H2O Storage Tanks	59-60
H2O Buffer Tanks	61-62
Hotline Indirect Water Heaters	63

TERMS & CONDITIONS OF SALE - GENERAL TERMS

PRICES & SPECIFICATIONS: All pricing and specifications subject to change without notice. The prices herein supersede all prior quotations.

PAYMENT TERMS: Net 30 Days

ORDERS: Orders will be accepted on the basis of prices in effect at the time the order is received. No order or contract will become an obligation on our part until accepted by the General Sales Department. ECR International shall not be liable for any delay or failure in the delivery or shipment of goods due to any cause or causes beyond its control.

TAXES: Add to the prices and terms quoted any manufacturers' or sales tax payable on the transaction under any effective statute.

SHIPMENT

TRUCK LOADS: \$40,000 Net Order Value - Freight Prepaid. Indirect Water Heaters and Commercial Boiler lines can be added to any residential order for freight purposes.

Authorized Distributors can combine Argo, Airco, Dunkirk, EMI, Olsen, Pennco and Utica and on one purchase order to earn free freight.

Stop off charges of \$150 will apply to stop off locations within 100 miles of final destination. Please call for pricing for stop off special handling for a location further than 100 miles or for special handling pricing for services such as lift gate, unloading assistance, etc.

LESS THAN TRUCKLOAD SHIPMENT: F.O.B. ECR INTERNATIONAL - FACTORY OR WAREHOUSE

ORDER INFORMATION CHECKLIST

The following information must be included on equipment or parts orders to insure proper shipment & invoicing:

- 1) Purchase Order Number
- 2) Bill To Address
- 3) Ship To Address
- 4) Method of Shipment (i.e. - trailer load, UPS, etc.)
- 5) Requested Ship Date
- 6) Special Instructions (i.e. - "Carrier to call...")
- 7) Pricing
- 8) Product Description (i.e. - Model, Size, Series, etc.)
- 9) Fuel Characteristics (i.e. Oil, Natural Gas, Propane)
- 10) Electrical Characteristics (i.e. - Operating Voltage, Cycles, Phases, etc.)
- 11) Non-Standard Equipment (Indicate "Optional" when substituted for standard equipment at extra cost listed. added to standard equipment).
- 12) Kits or Parts (Orders for kits or parts must indicate equipment size and series).
- 13) Send orders to:

E-Mail: ecrorderentry@ecrinternational.com

Fax: 315-724-9319

- 14) Please note the following Remit To Address:

**ECR International, Inc.
P.O. Box 8000 Department 039
Buffalo, NY 14267**

Continued on Next Page

TERMS & CONDITIONS OF SALE - GENERAL TERMS CONTINUED
U.S. DISTRIBUTOR - RETURN MATERIAL POLICY - EFFECTIVE 8/18/2014

To assist in providing the best service to our valued customers, ECR International has developed the following guidelines to help you in the unlikely event that you will need to return merchandise purchased from us. These guidelines have been developed after carefully reviewing common industry practice. We trust that you find them fair and easy to follow.

Prior Approval Required - All returns for exchange, credit, repair service or warranty claim must be approved by ECR and require an RMA number prior to return of the material. A request must be completed via ECR International's online web portal. Please log on to www.ecrcustomerportal.com (hyperlink below) to complete your request for return. If you do not already have access to the customer web portal please contact ECR Customer Service at 1-800-325-5479 to be set-up.

Eligibility - An RMA Request must be received within 60 days from the date of invoice for returns of New & Unused product in original packaging. A restocking fee of 15% will be charged for all new and unused returns that are approved for return. Special Order Products (items not offered as standard in ECR trade price book) are not eligible for return as new and unused product. Request for Warranty Returns must be made within the period covered by the warranty and must fall under the terms and conditions specified in the warranty.

Repair Service - Request for repair or rework of product damaged by customer is classified as Repair Service. Repair Service is billed at \$75.00 per hour for labor and net price for parts used in repair/rework. ECR's Return Material (RM) department will evaluate the items returned for repair service. The customer will receive an estimate for the dollar amount, determined by ECR's RM department, required to complete the repairs requested. A Purchase Order (PO) from the customer for that amount will be required before any work is performed.

RMA Expiration - Once the RMA number is issued, the product must be returned within 90 days of the RMA date, or the RMA will be canceled. Products approved for return that are received after 90 days from the RMA date will not be accepted.

Shipping & Packaging - All returns must have a valid RMA number clearly displayed on the exterior of the package or the package will not be accepted. All returns of new and unused product must be in the original packaging. All returns must be shipped prepaid by the customer unless otherwise directed by ECR as indicated on the RMA Verification. Ship all approved return material to the facility indicated on the approved RMA Request by the date indicated.

Replacement Product - If replacement product is desired it must be indicated on the RMA Request. A PO# is required for the replacement shipment and must be indicated on the RMA Request. All replacement products will be invoiced at the time of shipment. ECR will pay the ground freight for all warranty replacements.

Application of Credit - Credit for returned product will be applied to the customer's account (less restocking fees for New and Unused returns) only after confirmation of receipt by ECR and inspection of the product. Issuance of a credit for a partial return of product does not relieve the customer from the obligation to remit payment for the merchandise not returned in accordance with the payment terms referenced on the customer's invoice(s). Customer will have the option to have any product that is denied for credit returned at their expense.

<http://www.ecrcustomerportal.com>

SSC SERIES

NATURAL OR PROPANE
MODULATING CONDENSING
HOT WATER BOILER

150 psi
MAWP

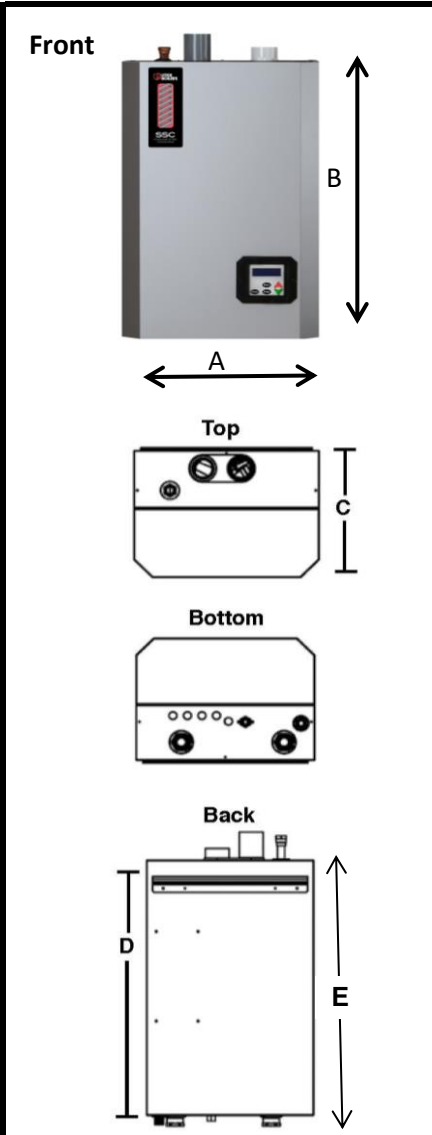
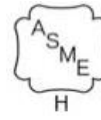

**Most Efficient
2018**
www.energystar.gov

All SSC models have an AFUE of 95% and meet the criteria for 2018 Most Efficient.

Dimensions		
Models	050	150
	075	200
Width "A"	20"	23"
	508 mm	584 mm
Height "B"	31"	42"
	787 mm	1067 mm
*Depth "C"	14-3/4"	*16"
	375 mm	406 mm
Bracket "D"	27.7"	38.7"
	704 mm	983 mm
Ht. w/Piping "E"	32"	43"
	813 mm	1092 mm

General Information (See IOM for complete instructions)

Clearances	Combustible Materials (Required) (1)		Service (2)		
	(1) Required distances measured from boiler.	Top	0" (0 cm)	14" (36 cm)	
Left Side		0" (0 cm)	0" (0 cm)		
Right Side		0" (0 cm)	0" (0 cm)		
Front		0" (0 cm)	6" (16 cm)		
Back		0" (0 cm)	0" (0 cm)		
Bottom		0" (0 cm)	12" (32 cm)		
(2) Service, proper operation clearance recommended.	Combustion Air/Vent Piping	0" (0 cm)	6" (16 cm)		
	Combustion Air & Vent Pipe Equiv. Length	(Schedule 40 PVC)			
Min. Length	2" Pipe		3" Pipe		4" Pipe
	50	75/100	75/100	150/200	299
Max. Length	6 Ft.	6 Ft.	6 Ft.	6 Ft.	6 Ft.
	(1.8 m)	(1.8 m)	(1.8 m)	(1.8 m)	(1.8 m)
Max. Length	100 Ft.	50 Ft.	100 Ft.	100 Ft.	25 Ft.
	(30.5 m)	(15.2 m)	(30.5 m)	(30.5 m)	(7.7 m)

Note: Refer to IOM and vent pipe manufacturer's instructions for equivalent vent lengths and alternate venting materials.

Connections	Return/Supply Water	Gas In	Cond. Drain
050/075/100	1-1/4" NPT	1/2" NPT	3/4" NPT
150/200/299	1-1/4" NPT	3/4" NPT	3/4" NPT
Electrical	120 Volts AC, 60 hertz, 1 phase, Less than 12 amps (15 amp circuit recommended)		
Water Content	050/075/100 - 1.1 Gallons, 150/200/299 - 1.8 Gallons		
*299 Dimensions are the same as 150/200 models except for Depth which is 18.4"/467 mm for the 299 model.			

SSC SERIES CONTINUED								
(NATURAL GAS - LESS SYSTEM PUMP)								
BOILER MODEL	ITEM NUMBER	TRADE PRICE	INPUT (MBH) MAX/ MIN	HTG. CAP. (MBH)	AHRI NET (MBH)	AFUE RATING %	FLUE DIA.	BLR./ SHP WGT. LBS.
UBSSC-50	SSC105003500210	\$4,072	50/10	46	40	95	2"	91/111
UBSSC-75	SSC107503500210	\$4,152	75/15	69	60	95	2" or 3"	91/111
UBSSC-100	SSC110003500210	\$4,344	100/20	91	79	95	2" or 3"	91/111
UBSSC-150	SSC115003500210	\$5,483	150/30	139	121	95	3"	157/182
UBSSC-200	SSC120003500210	\$5,855	200/40	185	161	95	3"	157/182
UBSSC-299	SSC129903500210	\$9,023	299/60	273	239	95	3" or 4"	195/225
(NATURAL GAS - WITH TACO ECM SYSTEM PUMP)								
BOILER MODEL	ITEM NUMBER	TRADE PRICE	INPUT (MBH) MAX/ MIN	HTG. CAP. (MBH)	AHRI NET (MBH)	AFUE RATING %	FLUE DIA.	BLR./ SHP WGT. LBS.
UBSSC-50	SSC105003540210	\$4,215	75/15	69	60	95	2" or 3"	91/111
UBSSC-75	SSC107503540210	\$4,295	75/15	69	60	95	2" or 3"	91/111
UBSSC-100	SSC110003540210	\$4,487	100/20	91	79	95	2" or 3"	91/111
UBSSC-150	SSC115003540210	\$5,626	150/30	139	121	95	3"	157/182
UBSSC-200	SSC120003540210	\$5,998	200/40	185	161	95	3"	157/182
(NATURAL GAS - WITH TACO ECM SYSTEM PUMP - HIGH ALTITUDE)								
BOILER MODEL	ITEM NUMBER	TRADE PRICE	INPUT (MBH) MAX/ MIN	HTG. CAP. (MBH)	AHRI NET (MBH)	AFUE RATING %	FLUE DIA.	BLR./ SHP WGT. LBS.
UBSSC-50	SSC105003542210	\$4,215	75/15	69	60	95	2" or 3"	91/111
UBSSC-75	SSC107503542210	\$4,295	75/15	69	60	95	2" or 3"	91/111
UBSSC-100	SSC110003542210	\$4,487	100/20	91	79	95	2" or 3"	91/111
UBSSC-150	SSC115003542210	\$5,626	150/30	139	121	95	3"	157/182
UBSSC-200	SSC120003542210	\$5,998	200/40	185	161	95	3"	157/182

(NATURAL GAS - WITH GRUNDFOS SYSTEM PUMP)

BOILER MODEL	ITEM NUMBER	TRADE PRICE	INPUT (MBH) MAX/ MIN	HTG. CAP. (MBH)	AHRI NET (MBH)	AFUE RATING %	FLUE DIA.	BLR./ SHP WGT. LBS.
UBSSC-50	SSC105003520210	\$4,215	50/10	46	40	95	2"	91/111
UBSSC-75	SSC107503520210	\$4,295	75/15	69	60	95	2" or 3"	91/111
UBSSC-100	SSC110003520210	\$4,487	100/20	91	79	95	2" or 3"	91/111
UBSSC-150	SSC115003520210	\$5,626	150/30	139	121	95	3"	157/182
UBSSC-200	SSC120003520210	\$5,998	200/40	185	161	95	3"	157/182

Note: The UB SSC299 is only available less system pump.

**SSC SERIES - VENTING OPTIONS/ADDITIONAL EQUIPMENT
(USE PARTS MULTIPLIER)**

	PN	TRADE
050 NATURAL TO LP AND LP TO NATURAL GAS CONVERSION KIT	550002303	\$47
075 NATURAL TO LP AND LP TO NATURAL GAS CONVERSION KIT	550002304	\$47
100 NATURAL TO LP AND LP TO NATURAL GAS CONVERSION KIT	550002305	\$47
150 NATURAL TO LP AND LP TO NATURAL GAS CONVERSION KIT	550002306	\$47
200 NATURAL TO LP AND LP TO NATURAL GAS CONVERSION KIT	550002307	\$47
299 NATURAL TO LP AND LP TO NATURAL GAS CONVERSION KIT	550002799	\$49
2" CONCENTRIC VENT KIT	29570	\$222
3" CONCENTRIC VENT KIT	29571	\$222
MULTIPLE BOILER SENSOR KIT	550002186	\$80
FLOOR STAND KIT	240010266	\$599

SSC SERIES - STANDARD EQUIPMENT

STANDARD EQUIPMENT:

- Wall Mounted: Bracket included.
- Boiler Control Module: Automatic Low Voltage/Intermittent Direct Spark Ignition/Modulating with a 5:1 combustion turn down ratio. For multiple boiler applications - the control module can stage up to 16 boilers.
- User Display interface: Easy programming with text display. Outdoor Temperature Sensor included.
- Heat Exchanger: High grade 316L/444 Stainless Steel Fin Coil with Flame Sight Glass.
- Built-in Primary/Secondary Manifold Piping and Pump.
- Combustion: Gas Valve with Premix Venturi and Blower, Durable Stainless Steel Mesh Modulating Burner with 5:1 turn down ratio, Direct Spark Igniter, Flame Sensor and LP Conversion Kit included.
- Electrical: Low Voltage Terminal Strip, High Voltage Junction Box and Transformer.
- Other: Factory installed probe-type Low Water Cut Off with test feature, 30 PSI Safety Relief Valve, Temperature Pressure Gauge, Boiler Drain Valve and Condensate Drain with built in trap.

SSV SERIES

NATURAL OR PROPANE
MODULATING CONDENSING
HOT WATER BOILER

150 psi
MAWP

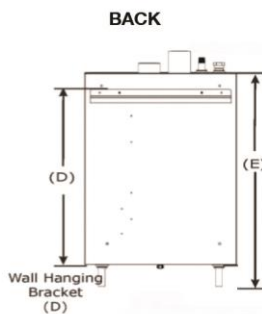
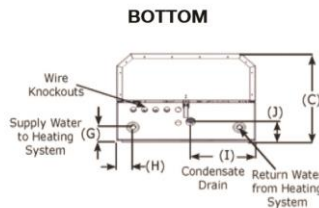
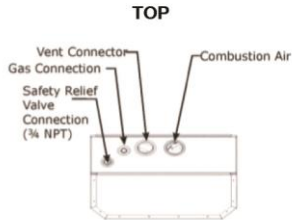
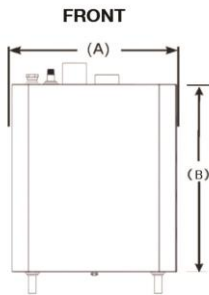
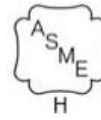

All SSV models have an AFUE of 95% and meet the criteria for 2018 Most Efficient.



General Information (See IOM for complete instructions)

Clearances	Combustible Materials (Required) (1)		Service (2)	
	(1) Required distances measured from boiler jacket.	Top	0" (0 cm)	14" (36 cm)
Left Side		0" (0 cm)	0" (0 cm)	
Right Side		0" (0 cm)	0" (0 cm)	
Front		0" (0 cm)	6" (16 cm)	
Back		0" (0 cm)	0" (0 cm)	
Bottom		0" (0 cm)	12" (32 cm)	
(2) Service, proper operation clearance recommended.	Combustion Air/Vent Piping	0" (0 cm)	6" (16 cm)	
	Hot Wat. Piping	See Local Code	6" (16 cm)	
Combustion Air & Vent Pipe Equiv. Length	(Schedule 40 PVC)			
	2" Pipe		3" Pipe	
Min. Length	50	75/100	75/100	150/200
	6 Ft. (1.8 m)	6 Ft. (1.8 m)	6 Ft. (1.8 m)	6 Ft. (1.8 m)
Max. Length	100 Ft. (30.5 m)	50 Ft. (15.2 m)	100 Ft. (30.5 m)	100 Ft. (30.5 m)

Note: Refer to IOM and vent pipe manufacturer's instructions for equivalent vent lengths and alternate venting materials.

Dimensions		
Models	050	150
	075	200
	100	
Width "A"	20"	23"
	508 mm	584 mm
Height "B"	27.75"	37.75"
	705 mm	959 mm
Depth "C"	14.75"	16.3"
	375 mm	414 mm
Bracket "D"	24.41"	35.6"
	620 mm	904 mm
Ht. w/Piping "E"	30.75"	40.75"
	781 mm	104 cm

Connections	Return/Supply Water	Gas In	Cond. Drain
050/075/100	3/4" Copper Stub	1/2" NPT	3/4" NPT
150/200	1" Copper Stub	3/4" NPT	3/4" NPT
Electrical	120 Volts AC, 60 hertz, 1 phase, Less than 12 amps (15 amp circuit recommended)		
Water Content	050/075/100 - 1.1 Gallons, 150/200 - 1.8 Gallons		

SSV SERIES CONTINUED								
(NATURAL GAS - LESS SYSTEM PUMP)								
BOILER MODEL	ITEM NUMBER	TRADE PRICE	INPUT (MBH) MAX/ MIN	HTG. CAP. (MBH)	AHRI NET (MBH)	AFUE RATING %	FLUE DIA.	BLR./ SHP WGT. LBS.
SSV-50	SSV105003500110	\$3,359	50/10	46	40	95	2"	91/111
SSV-75	SSV107503500110	\$3,460	75/15	69	60	95	2"	91/111
SSV-100	SSV110003500110	\$3,567	100/20	91	79	95	2"	91/111
SSV-150	SSV115003500110	\$4,817	150/30	139	121	95	3"	157/182
SSV-200	SSV120003500110	\$5,030	200/40	185	161	95	3"	157/182
(NATURAL GAS - TACO ECM SYSTEM PUMP)								
BOILER MODEL	ITEM NUMBER	TRADE PRICE	INPUT (MBH) MAX/ MIN	HTG. CAP. (MBH)	AHRI NET (MBH)	AFUE RATING %	FLUE DIA.	BLR./ SHP WGT. LBS.
SSV-50	SSV105003540110	\$3,502	50/10	46	40	95	2"	91/111
SSV-75	SSV107503540110	\$3,603	75/15	69	60	95	2"	91/111
SSV-100	SSV110003540110	\$3,710	100/20	91	79	95	2"	91/111
SSV-150	SSV115003540110	\$4,960	150/30	139	121	95	3"	157/182
SSV-200	SSV120003540110	\$5,173	200/40	185	161	95	3"	157/182
(NATURAL GAS - GRUNDFOS SYSTEM PUMP)								
BOILER MODEL	ITEM NUMBER	TRADE PRICE	INPUT (MBH) MAX/ MIN	HTG. CAP. (MBH)	AHRI NET (MBH)	AFUE RATING %	FLUE DIA.	BLR./ SHP WGT. LBS.
SSV-50	SSV105003520110	\$3,502	50/10	46	40	95	2"	91/111
SSV-75	SSV107503520110	\$3,603	75/15	69	60	95	2"	91/111
SSV-100	SSV110003520110	\$3,710	100/20	91	79	95	2"	91/111
SSV-150	SSV115003520110	\$4,960	150/30	139	121	95	3"	157/182
SSV-200	SSV120003520110	\$5,173	200/40	185	161	95	3"	157/182
SSV SERIES - VENTING OPTIONS/ADDITIONAL EQUIPMENT						PN	TRADE	
(USE PARTS MULTIPLIER)								
050 NATURAL TO LP AND LP TO NATURAL GAS CONVERSION KIT						550002303	\$47	
075 NATURAL TO LP AND LP TO NATURAL GAS CONVERSION KIT						550002304	\$47	
100 NATURAL TO LP AND LP TO NATURAL GAS CONVERSION KIT						550002305	\$47	
150 NATURAL TO LP AND LP TO NATURAL GAS CONVERSION KIT						550002306	\$47	
200 NATURAL TO LP AND LP TO NATURAL GAS CONVERSION KIT						550002307	\$47	
2" CONCENTRIC VENT KIT						29570	\$222	
3" CONCENTRIC VENT KIT						29571	\$222	
MULTIPLE BOILER SENSOR KIT						550002186	\$80	
FLOOR STAND KIT						240010266	\$599	

SSV SERIES - STANDARD EQUIPMENT

STANDARD EQUIPMENT:

- Wall Mounted: Bracket included.
- Boiler Control Module: Automatic Low Voltage/Intermittent Direct Spark Ignition/Modulating with a 5:1 combustion turn down ratio. For multiple boiler applications - the control module can stage up to 16 boilers.
- User Display interface: Easy programming with text display. Remote mount option utilizes standard thermostat (2) conductor wiring. Outdoor Temperature Sensor included.
- Heat Exchanger: High grade 316L/444 Stainless Steel Fin Coil with Flame Sight Glass.
- Combustion: Gas Valve with Premix Venturi and Blower, Durable Stainless Steel Mesh Modulating Burner with 5:1 turn down ratio, Direct Spark Igniter, Flame Sensor.
- Electrical: Low Voltage Terminal Strip, High Voltage Junction Box and Transformer.
- Other: 30 PSI Safety Relief Valve, Temperature Pressure Gauge, Boiler Drain Valve and Condensate Drain

UCS 240

NATURAL OR PROPANE KIT
 CONDENSING HOT WATER BOILER
 WALL MOUNT OR FLOOR BASE
 6.7:1 TURNDOWN RATIO

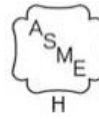

The UCS 240 has an AFUE of 95% and meets the criteria for 2018 Most Efficient and Primary/Secondary Manifold is included.

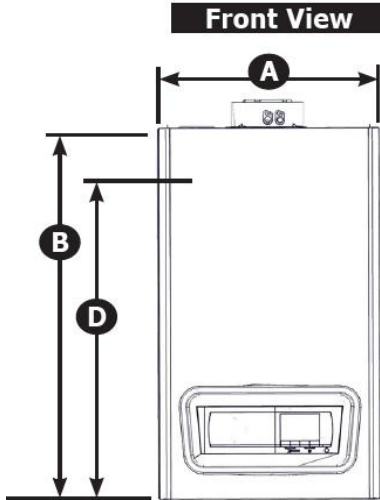

Bottom View Dimensions

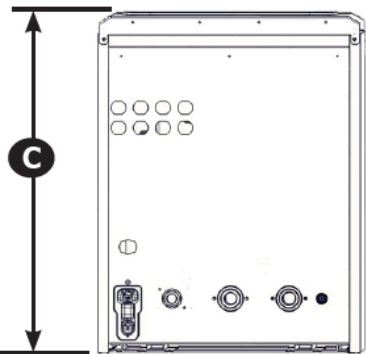

General Information (See IOM for complete instructions)

Clearances	Combustible Materials (Required) (1)		Service (2)
	1) Required distances measured from boiler jacket.	Top	0" (0 mm)
Left Side		1-3/4" (45 mm)	1-3/4" (45 mm)
Right Side		1-3/4" (45 mm)	1-3/4" (45 mm)
Front		2" (51 mm)	17-3/4" (450 mm)
Back		0" (0 mm)	0" (0 mm)
Bottom		0" (0 mm)	*9-7/8" (250 mm)
(2) Service, proper operation clearance recommended. (*) Allowance for Piping at the bottom of boiler not included	Combustion Air/Vent Piping	0" (0 mm)	6" (160 mm)
Connections UCS-240	Gas Connection 3/4" NPT 1" NPT Heating System Supply & Return (without manifold) 1-1/2" Copper Stub Heating System Supply & Return (with manifold)		





Dimensions	
Model 240 - Physical Data	
Width "A"	17 - 3/4"
	450 mm
Height "B"	31 - 1/16"
	763 mm
Depth "C"	23"
	585 mm
Bracket on Back "D"	15 - 7/8"
	403.2 mm

Water Content	0.8 Gallons
Note: Refer to IOM and vent pipe manufacturer's instructions for equivalent vent lengths and alternate venting materials.	
Electrical	120 Volts AC, 60 hertz, 1 phase, Less than 12 amps (15 amp circuit recommended)
Shipping Weight	145 lbs. (65.8kg)







UCS 240 CONTINUED								
(NATURAL GAS - LESS PRIMARY PUMP)								
BOILER MODEL	ITEM NUMBER	TRADE PRICE	INPUT RATE (MBH)	HTG. CAP. (MBH)	NET RATING WATER (MBH)	AFUE RATING %	VENTING COAXIAL	VENTING 2-PIPE
UCS-240	UCS124000600110	\$7,500	241,000	216,000	188,000	95	3" / 5"	3"
UCS 240 CONTINUED								
UCS 240 - VENTING OPTIONS/ADDITIONAL EQUIPMENT (USE PARTS MULTIPLIER)					PN	TRADE		
MANUAL RESET HIGH LIMIT KIT L4006E1109					550003322	\$235		
MANUAL RESET LWCO KIT					550003323	\$225		
CSD-1 KIT (INCLUDES HIGH LIMIT AND MANUAL RESET LWCO)					550003332	\$460		
COMMON VENTING CHECK VALVE KIT					550003354	\$330		
LP CONVERSION KIT					550003316	\$150		
OUTDOOR AIR SENSOR					BD710487302V	\$33		
DHW SENSOR KIT					550003189	\$72		
FLOOR BASE KIT					550003304	\$465		
UCS 240 - STANDARD EQUIPMENT								
STANDARD EQUIPMENT:								
<ul style="list-style-type: none"> - Boiler Control Module: High Limit/Electronic Ignition Control. - User Display Interface: Digital Temperature Display with diagnostics and programmable settings. - Heat Exchanger: 316L Stainless Steel - Combustion: 6.7:1 Turndown, Stainless Steel Burner, Direct Spark Ignition, Combination Flame Sensor and Ignitor - Other: Assembled Boiler with Jacket, Built-In Boiler Loop Pump, 50 psi Relief Valve Low Water Pressure Sensor, Temperature/Pressure Gauge <p>Optional: Outdoor Temperature Sensor, Indirect Tank Sensor, Floor Base Kit, CSD-1 Kits available (includes Manual Reset Low Water Cut Off and Manual Reset High Limit.).</p>								

* Vent accessories listed on the next page.

(USE PARTS MULTIPLIER FOR ALL OF THE FOLLOWING)**UCS 240 VENTING MATERIALS****COAXIAL VENTING**

VENTING COAXIAL	DESCRIPTION	ITEM	TRADE PRICE
	Coaxial Pipe 3.28' (1m) Long	KHG714088512	\$52
	Coaxial 90 Elbows	KHG714088712	\$28
	Coaxial 45 Elbows	KHG714088812	\$28
	Horizontal Vent Termination	KHG714088911	\$59
	Vertical Vent Termination	KHG714093512	\$83

TWIN PIPE POLYPROPYLENE VENTING

POLYPROPYLENE VENTING	DESCRIPTION	ITEM	TRADE PRICE
	Boiler Appliance Twin Pipe Adapters For Polypropylene	KHG714089010	\$36
	80mm Venting Clamp	550003416	\$34
	Polypropylene Pipe 3.28' (1m) Long	KUG714132610	\$16
	Polypropylene 90 Elbows	KUG714132410	\$11
	Polypropylene 45 Elbows	KUG714132310	\$11
	Horizontal Vent Termination	KUG714132010	\$18
	Vertical Vent Termination	KUG714132110	\$44

TWIN PIPE CPVC UL1738 / S636 VENTING ADAPTER KIT

	DESCRIPTION	ITEM	TRADE PRICE
	Boiler Appliance Twin Pipe Adapter Kit For 3" CPVC UL1738 / S636	550003403	\$100

UCS 380

NATURAL OR PROPANE KIT
 CONDENSING HOT WATER BOILER
 FLOOR STANDING BOILER
 10.5:1 TURNDOWN RATIO

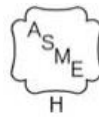

Front View

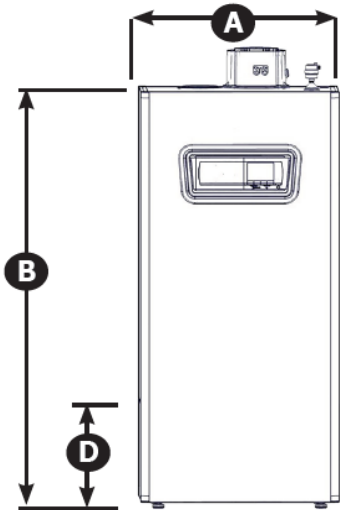

Bottom View Dimensions

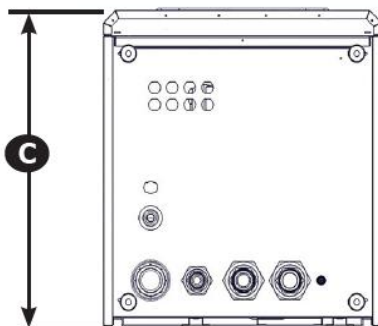

The UCS 380 has a Thermal Efficiency of 95% and Primary/Secondary Manifold is included.



General Information (See IOM for complete instructions)

Clearances	Combustible Materials (Required) (1)		Service (2)
	1) Required distances measured from boiler jacket.	Top	0" (0 mm)
Left Side		1-3/4" (45 mm)	1-3/4" (45 mm)
Right Side		1-3/4" (45 mm)	1-3/4" (45 mm)
Front		2" (51 mm)	23-5/8" (600 mm)
Back		0" (0 mm)	0" (0 mm)
Bottom		0" (0 mm)	0" (0 mm)
(2) Service, proper operation clearance recommended.	Combustion Air/Vent Piping	0" (0 mm)	6" (160 mm)

Connections UCS-380	Gas Connection 1" NPT 1-1/2" NPT Heating System Supply & Return (without manifold) 1-1/2" Copper Stub Heating System Supply & Return (with manifold)		
----------------------------	--	--	--

Water Content	4.6 Gallons		
----------------------	-------------	--	--

Note: Refer to IOM and vent pipe manufacturer's instructions for equivalent vent lengths and alternate venting materials.

Electrical	120 Volts AC, 60 hertz, 1 phase, Less than 12 amps (15 amp circuit recommended)		
-------------------	---	--	--

Shipping Weight	255 lbs. (115.7kg)		
------------------------	--------------------	--	--

Dimensions	
Model 380 - Physical Data	
Width "A"	23 - 5/8"
	600 mm
Height "B"	50"
	1270 mm
Depth "C"	23 - 1/2"
	648 mm
Bracket on Back "D"	11 - 3/4"
	298.5 mm

UCS 380 CONTINUED								
(NATURAL GAS - LESS PRIMARY PUMP)								
BOILER MODEL	ITEM NUMBER	TRADE PRICE	INPUT RATE (MBH)	HTG. CAP. (MBH)	NET RATING WATER (MBH)	THERMAL EFF. %	VENTING COAXIAL	VENTING 2-PIPE
UCS-380	UCS138000600110	\$9,475	379,000	348,000	303,000	95	4" / 6"	4"

UCS 380 - VENTING OPTIONS/ADDITIONAL EQUIPMENT (USE PARTS MULTIPLIER)			PN	TRADE
MANUAL RESET HIGH LIMIT KIT L4006E1109			550003322	\$235
MANUAL RESET LWCO KIT			550003323	\$225
CSD-1 KIT (INCLUDES HIGH LIMIT AND MANUAL RESET LWCO)			550003332	\$460
COMMON VENTING CHECK VALVE KIT			550003354	\$330
LP CONVERSION KIT			550003317	\$150
OUTDOOR AIR SENSOR			BD710487302V	\$33
DHW SENSOR KIT			550003189	\$72





UCS 380 - STANDARD EQUIPMENT	
<u>STANDARD EQUIPMENT:</u>	
<ul style="list-style-type: none"> - Boiler Control Module: High Limit/Electronic Ignition Control. - User Display Interface: Digital Temperature Display with diagnostics and programmable settings. - Heat Exchanger: 316L Stainless Steel - Combustion: 10.5:1 Turndown, Stainless Steel Burner, Direct Spark Ignition, Combination Flame Sensor and Ignitor - Other: Assembled Boiler with Jacket, Built-In Boiler Loop Pump, 50 psi Relief Valve Low Water Pressure Sensor, Temperature/Pressure Gauge 	
Optional: Outdoor Temperature Sensor, Indirect Tank Sensor, Floor Base Kit, CSD-1 Kits available (includes	

* Vent accessories listed on the next page.







(USE PARTS MULTIPLIER FOR ALL OF THE FOLLOWING)

UCS 380 VENTING MATERIALS

COAXIAL VENTING

VENTING COAXIAL	DESCRIPTION	ITEM	TRADE PRICE
	Coaxial Pipe 3.28' (1m) Long	KUG714133811	\$107
	Coaxial 90 Elbows	KUG714133611	\$77
	Coaxial 45 Elbows	KUG714133511	\$77
	Horizontal Vent Termination	KUG714133311	\$218
	Vertical Vent Termination	KUG714133411	\$278

TWIN PIPE POLYPROPYLENE VENTING

POLYPROPYLENE VENTING	DESCRIPTION	ITEM	TRADE PRICE
	Boiler Appliance Twin Pipe Adapters For 4" UL1738 / S636	BD7106314V	\$118
	Polypropylene Pipe 3.28' (1m) Long	KUG714133210	\$30
	Polypropylene 90 Elbows	KUG714133010	\$19
	Polypropylene 45 Elbows	KUG714132910	\$19
	Horizontal Vent Termination	KUG714132710	\$111
	Vertical Vent Termination	KUG714132810	\$101

MAC/MAH
 NATURAL OR PROPANE
 MODULATING CONDENSING
 SPACE HEATING ONLY & COMBI

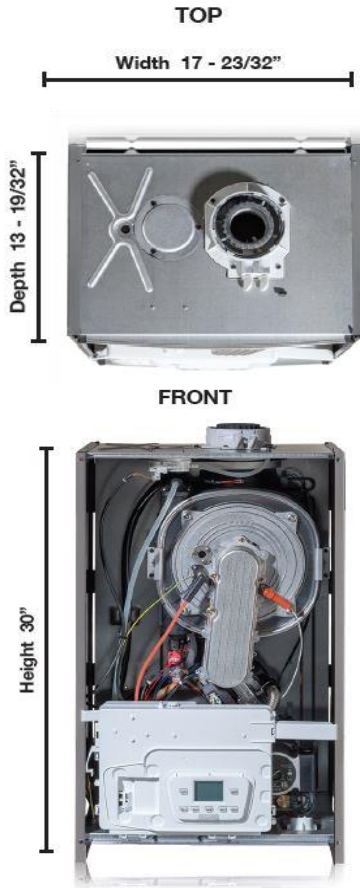

All MAC models have an AFUE of 95% and meet the criteria for 2018 Most Efficient and Primary/Secondary Manifold is included.



General Information (See IOM for complete instructions)

Clearances	Combustible Materials (Required) (1)		Service (2)
	Top	0" (0 cm)	
1) Required distances measured from boiler.	Left Side	1.77" (4.5 cm)	1.77" (4.5 cm)
	Right Side	1.77" (4.5 cm)	1.77" (4.5 cm)
	Front	1.57" (4.0 cm)	17.70" (45 cm)
	Back	0" (0 cm)	0" (0 cm)
	Bottom	0" (0 cm)	9.84" (25 cm)
	(2) Service, proper operation clearance recomm.	Combustion Air/Vent Piping	0" (0 cm)

Note: Boiler requires special venting - Use only venting systems that have been approved. Refer to Page 14





Coaxial Venting	2-pipe Polypropylene venting - Boiler Adapter Kit Required	2-pipe CPVC UL1738/ULC S636 Boiler Adapter Kit Required
-----------------	--	---

Dimensions			MAC & MAH		MAC & MAH		MAC & MAH	
Models	MAC-150	MAH-125	Feet (Ft)	Meters (m)	Feet (Ft)	Meters (m)	Feet (Ft)	Meters (m)
Width	17-23/32"	17-23/32"	32.8 Ft.	10 m	196.8 Ft. Combined	60 m	196.8 Ft. Combined	60 m
Height	30"	30"			Intake Air can not exceed 49.2 Ft.	15 m	Intake Air can not exceed 49.2 Ft.	15 m
Depth	13-19/32"	13-19/32"	Connections		Return/Supply Water		Gas In	
Weight (lbs.)	103	102	MAC-150 & MAH-125		3/4" SWT		3/4" FPT	
			MAC-150 DHW		1/2" SWT			
			Electrical					
			120 Volts AC, 60 hertz, 1 phase, Less than 12 amps (15 amp circuit recommended)					
			Water Content					
			125/150 - 0.95 Gallons					







MAC/MAH CONTINUED*								
(NATURAL AND LP GAS - LESS SYSTEM PUMP, COMBI OR HEATING ONLY)								
BOILER MODEL	ITEM NUMBER	TRADE PRICE	INPUT RATE (MBH)	HTG. CAP. (MBH)	AHRI NET (MBH)	AFUE RATING %	VENTING COAXIAL	VENTING 2-PIPE
Space Heating Model								
MAH125	MAH112503600110	\$2,906	126	113	98	95.0	3.93"	3"
Combi Model								
MAC150	MAC115003600110	\$3,103						
Central Heating Mode			126	113	98	95.0	3.93"	3"
Domestic Hot Water Mode			153	136	N/A			
(NATURAL AND LP GAS - WITH TACO ECM SYSTEM PUMP, COMBI OR HEATING ONLY)								
BOILER MODEL	ITEM NUMBER	TRADE PRICE	INPUT RATE (MBH)	HTG. CAP. (MBH)	AHRI NET (MBH)	AFUE RATING %	VENTING COAXIAL	VENTING 2-PIPE
Space Heating Model								
MAH125	MAH112503640110	\$3,053	126	113	98	95.0	3.93"	3"
Combi Model								
MAC150	MAC115003640110	\$3,251						
Central Heating Mode			126	113	98	95.0	3.93"	3"
Domestic Hot Water Mode			153	136	N/A			
(NATURAL AND LP GAS - WITH GRUNDFOS SYSTEM PUMP, COMBI OR HEATING ONLY)								
BOILER MODEL	ITEM NUMBER	TRADE PRICE	INPUT RATE (MBH)	HTG. CAP. (MBH)	AHRI NET (MBH)	AFUE RATING %	VENTING COAXIAL	VENTING 2-PIPE
Space Heating Model								
MAH125	MAH112503620110	\$3,053	126	113	98	95.0	3.93"	3"
Combi Model								
MAC150	MAC115003620110	\$3,251						
Central Heating Mode			126	113	98	95.0	3.93"	3"
Domestic Hot Water Mode			153	136	N/A			
MAC/MAH - STANDARD EQUIPMENT								
<p><u>STANDARD EQUIPMENT:</u></p> <ul style="list-style-type: none"> -Boiler Control Module: High Limit/Electronic Ignition Control. -User Display Interface: Digital Temperature Display with diagnostics and programmable settings. -Heat Exchanger: Stainless Steel -3-Way Water Diverting Valve <p>Combustion: Automatically modulating gas valve with 5.7:1 Turndown for CH & 7:1 for DHW, Stainless Steel Burner, Direct Spark Ignition, Separate Flame Sensor, 100% shutoff.</p> <p>-Other: Assembled Boiler with Jacket, Induced Draft Fan, Circulator Pump, 30psi Relief Valve, Low Water Pressure Switch, Air Pressure Switch, Temperature/Pressure Gauge.</p> <p>MAC-150 DHW Model: Domestic Hot Water (DHW) Brazed Plate: Stainless Steel with 3.5 GPM @ 70° F</p>								

*These boilers require vent accessories on the next page.

(USE PARTS MULTIPLIER FOR ALL OF THE FOLLOWING)**MAC/MAH VENTING MATERIALS****COAXIAL VENTING**

VENTING COAXIAL	DESCRIPTION	ITEM	TRADE PRICE
	Coaxial Pipe 3.28' (1m) Long	KUG714059511	\$36
	Coaxial 90 Elbows	KUG714059711	\$27
	Coaxial 45 Elbows	KUG714059811	\$27
	Horizontal Vent Termination	KUG714059611	\$45
	Vertical Vent Termination	KUG714135812	\$106

TWIN PIPE POLYPROPYLENE VENTING

POLYPROPYLENE VENTING	DESCRIPTION	ITEM	TRADE PRICE
	Boiler Appliance Twin Pipe Adapters For Polypropylene	KHG714059113	\$16
	80mm Venting Clamp	550003416	\$34
	Polypropylene Pipe 3.28' (1m) Long	KUG714132610	\$16
	Polypropylene 90 Elbows	KUG714132410	\$11
	Polypropylene 45 Elbows	KUG714132310	\$11
	Horizontal Vent Termination	KUG714132010	\$18
	Vertical Vent Termination	KUG714132110	\$44

TWIN PIPE CPVC UL1738 / S636 VENTING ADAPTERS

	DESCRIPTION	ITEM	TRADE PRICE
	Boiler Appliance Twin Pipe Adapters For 3" CPVC UL1738 / S636	550003184	\$55

OPTIONAL ITEMS

	PN	TRADE PRICE
OUTSIDE AIR SENSOR	BD710487302V	\$33
DHW SENSOR KIT	550003189	\$72
FLOOR STAND KIT	240010266	\$599

97GB SERIES

NATURAL OR PROPANE
MODULATING CONDENSING
HOT WATER BOILER
FLOOR/WALL MOUNT

150 psi
MAWP

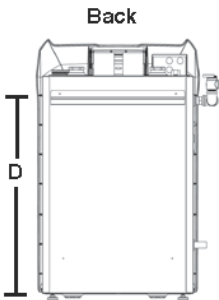
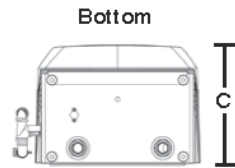
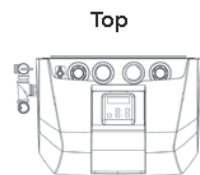
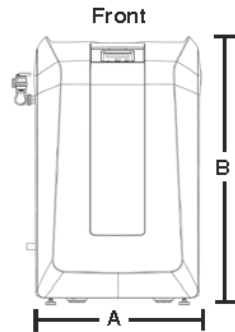
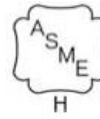

Floor Mount Capable



General Information (See IOM for complete instructions)

Clearances	Combustible Materials (Required) (1)		Service (2)
	1) Required distances measured from boiler.	Top	0" (0 cm)
Left Side		6" (16 cm)	6" (16 cm)
Right Side		0" (0 cm)	1-1/2" (4 cm)
Front		0" (0 cm)	6" (16 cm)
Back		0" (0 cm)	0" (0 cm)
Bottom		0" (0 cm)	12" (32 cm) for Bottom Piped
(2) Service, proper operation clearance recommended.	Combustion Air/Vent Piping	0" (0 cm)	6" (16 cm)
	(Schedule 40 PVC)		
Combustion Air & Vent Pipe Equiv. Length	2" Pipe	3" Pipe	
	075/100	075/100	
Min. Length	6 Ft.	6 Ft.	
	(1.8 m)	(1.8 m)	
Max. Length	50 Ft.	100 Ft.	
	(15.2 m)	(30.5 m)	

Note: Refer to IOM and vent pipe manufacturer's instructions for equivalent vent lengths and alternate venting materials.

Dimensions	
Models	075/100
Width "A"	22-1/16" (560 mm)
Height "B"	35-5/8" (905 mm)
Depth "C"	16-3/16" (411 mm)
Bracket "D"	27-1/2" (969 mm)

Connections	Return/Supply Water	Gas In	Cond. Drain
075/100	1-1/4" NPT	1/2" NPT	3/4" MPT
Electrical	120 Volts AC, 60 hertz, 1 phase, Less than 12 amps (15 amp circuit recommended)		
Water Content	075/100 - 1.1 Gallons		

97GB SERIES CONTINUED								
(NATURAL GAS - LESS SYSTEM PUMP)								
BOILER MODEL	ITEM NUMBER	TRADE PRICE	INPUT (MBH) MAX/MIN	HTG. CAP. (MBH)	AHRI NET (MBH)	AFUE RATING %	FLUE DIA.	BLR./ SHP WGT. LBS.
ECR97-075	ECR97A075N000UB	\$4,152	75	15	60	95	2" or 3"	140
ECR97-100	ECR97A100N000UB	\$4,344	100	20	79	95	2" or 3"	140
(NATURAL GAS - WITH TACO ECM SYSTEM PUMP)								
BOILER MODEL	ITEM NUMBER	TRADE PRICE	INPUT (MBH) MAX/MIN	HTG. CAP. (MBH)	AHRI NET (MBH)	AFUE RATING %	FLUE DIA.	BLR./ SHP WGT. LBS.
ECR97-075	ECR97A075N400UB	\$4,305	75	15	60	95	2" or 3"	140
ECR97-100	ECR97A100N400UB	\$4,497	100	20	79	95	2" or 3"	140
(NATURAL GAS - WITH GRUNDFOS SYSTEM PUMP)								
BOILER MODEL	ITEM NUMBER	TRADE PRICE	INPUT (MBH) MAX/MIN	HTG. CAP. (MBH)	AHRI NET (MBH)	AFUE RATING %	FLUE DIA.	BLR./ SHP WGT. LBS.
ECR97-075	ECR97A075N300UB	\$4,305	75	15	60	95	2" or 3"	140
ECR97-100	ECR97A100N300UB	\$4,497	100	20	79	95	2" or 3"	140
ECR97GB SERIES - VENTING OPTIONS/ADDITIONAL EQUIPMENT								
(USE PARTS MULTIPLIER)						PN	TRADE	
ECR97 075 GAS CONVERSION KIT (NAT. TO LP & LP TO NAT.)						550002171	\$50	
ECR97 100 GAS CONVERSION KIT (NAT. TO LP & LP TO NAT.)						550002172	\$40	
2" CONCENTRIC VENT KIT						29570	\$222	
3" CONCENTRIC VENT KIT						29571	\$222	
MULTIPLE BOILER SENSOR KIT						550002186	\$80	
97GB SERIES - STANDARD EQUIPMENT								
<u>STANDARD EQUIPMENT:</u>								
<ul style="list-style-type: none"> - Mounting Floor/Wall: Leveling Legs and Wall Bracket both included. - Boiler Control Module: Automatic Low Voltage/Intermittent Power Reset. Controls up to 16 boilers for multiple boiler applications. - User Display interface: Easy programming with text display. Remote mount option utilizes standard thermostat conductor wiring. - Heat Exchanger: High grade 316L/444 Stainless Steel Fin Coil with Flame Sight Glass. Built-in Primary/Secondary Manifold Piping and Pump. - Combustion: Gas Valve with Premix Venturi and Blower, Durable Stainless Steel Mesh Burner, Direct Spark Igniter, Flame Sensor and LP Conversion Kit included. - Electrical: Detachable Low Voltage Terminal Strip, High Voltage Junction Box, Transformer, Lighted Power Switch and Auxiliary Service Power Outlet. - Other: Low Water Cut Off with test feature, Outdoor Temperature Reset, 30 PSI Safety Relief Valve, Boiler Drain Valve and Condensate Drain with built in trap. 								

UB90-100 SERIES IV
NATURAL OR PROPANE 50 psi
CONDENSING MAWP
HOT WATER BOILER

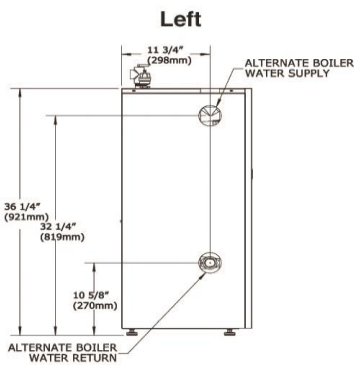
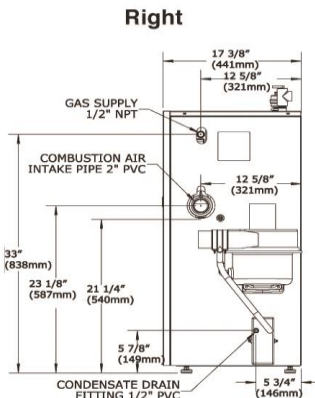
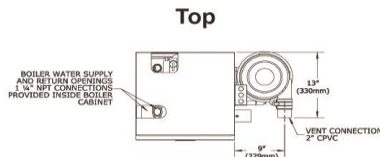
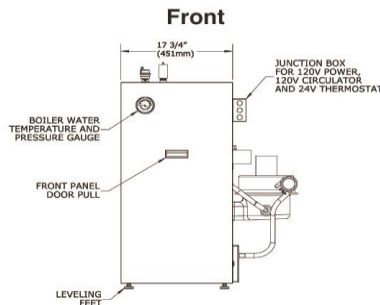
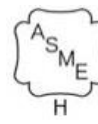

General Information (See IOM for complete instructions)

Clearances	Combustible Materials				Service (2)
	(Required) (1)				
(1) Required distances measured from boiler.	Top	1" (26 mm)		8" (204 mm)	
	Left Side	1" (26 mm)		N/A	
	Right Side	11" (280 mm)		N/A	
	Base	1" (26 mm)		N/A	
	Front	1" (26 mm)		24" (610 mm)	
	Back	1" (26 mm)		N/A	
(2) Service, proper operation clearance recommendation.	Combustion Air/Vent Piping	0" (0 mm)		N/A	
Combustion Air & Vent Pipe Equivalent Length (Schedule 40 PVC)	Min. Length	2" Pipe 050	2" Pipe 100	3" Pipe 050	3" Pipe 100
		075		075	
	Max. Length	2 Ft. (.61 m)	2 Ft. (.61 m)	20 Ft. (6.09 m)	15 Ft. (4.57 m)
		26 Ft. (7.92 m)	21 Ft. (6.40 m)	112 Ft. (34.14 m)	92 Ft. (28.04 m)
Note: Refer to IOM and vent pipe manufacturer's instructions for equivalent vent lengths and alternate venting materials.					
Connections	Return/Supply Water	Gas In	Condensate Drain		
Dimensions	050/075/100	1-1/4" NPT	1/2" NPT	1/2" CPVC Stub	
Width	17-3/4" (451 mm)				
Height	36-1/4" (921 mm)				
Depth	17-3/8" (441 mm)				
Electrical	120 Volts AC, 60 hertz, 1 phase, Less than 12 amps (15 amp circuit recommended)				
Water Content	050/075/100 - 2.6 Gallons				

UB90-100 SERIES IV CONTINUED								
(NATURAL GAS - LESS SYSTEM PUMP)								
BOILER MODEL	ITEM NUMBER	TRADE PRICE	INPUT (MBH)	HTG. CAP. (MBH)	AHRI NET (MBH)	AFUE RATING %	FLUE DIA.	SHIP WGT.
UB90-50	U90205003200410	\$3,352	50	45	39	90	2" or 3"	256
UB90-75	U90207503200410	\$3,352	75	68	59	90	2" or 3"	256
UB90-100	U90210003200410	\$3,352	100	90	78	90	2" or 3"	256
(NATURAL GAS - WITH TACO ECM SYSTEM PUMP)								
BOILER MODEL	ITEM NUMBER	TRADE PRICE	INPUT (MBH)	HTG. CAP. (MBH)	AHRI NET (MBH)	AFUE RATING %	FLUE DIA.	SHIP WGT.
UB90-50	U90205003240410	\$3,422	50	45	39	90	2" or 3"	256
UB90-75	U90207503240410	\$3,422	75	68	59	90	2" or 3"	256
UB90-100	U90210003240410	\$3,422	100	90	78	90	2" or 3"	256
(NATURAL GAS - WITH GRUNDFOS SYSTEM PUMP)								
BOILER MODEL	ITEM NUMBER	TRADE PRICE	INPUT (MBH)	HTG. CAP. (MBH)	AHRI NET (MBH)	AFUE RATING %	FLUE DIA.	SHIP WGT.
UB90-50	U90205003220410	\$3,422	50	45	39	90	2" or 3"	256
UB90-75	U90207503220410	\$3,422	75	68	59	90	2" or 3"	256
UB90-100	U90210003220410	\$3,422	100	90	78	90	2" or 3"	256
(LP GAS - LESS SYSTEM PUMP)								
BOILER MODEL	ITEM NUMBER	TRADE PRICE	INPUT (MBH)	HTG. CAP. (MBH)	AHRI NET (MBH)	AFUE RATING %	FLUE DIA.	SHIP WGT.
UB90-50	U90205013200410	\$3,352	50	45	39	90	2" or 3"	256
UB90-75	U90207513200410	\$3,352	75	68	59	90	2" or 3"	256
UB90-100	U90210013200410	\$3,352	100	90	78	90	2" or 3"	256
(LP GAS - WITH TACO ECM SYSTEM PUMP)								
BOILER MODEL	ITEM NUMBER	TRADE PRICE	INPUT (MBH)	HTG. CAP. (MBH)	AHRI NET (MBH)	AFUE RATING %	FLUE DIA.	SHIP WGT.
UB90-50	U90205013240410	\$3,422	50	45	39	90	2" or 3"	256
UB90-75	U90207513240410	\$3,422	75	68	59	90	2" or 3"	256
UB90-100	U90210013240410	\$3,422	100	90	78	90	2" or 3"	256
(LP GAS - WITH GRUNDFOS SYSTEM PUMP)								
BOILER MODEL	ITEM NUMBER	TRADE PRICE	INPUT (MBH)	HTG. CAP. (MBH)	AHRI NET (MBH)	AFUE RATING %	FLUE DIA.	SHIP WGT.
UB90-50	U90205013220410	\$3,422	50	45	39	90	2" or 3"	256
UB90-75	U90207513220410	\$3,422	75	68	59	90	2" or 3"	256
UB90-100	U90210013220410	\$3,422	100	90	78	90	2" or 3"	256
(USE PARTS MULTIPLIER FOR ALL OF THE FOLLOWING)					PN	TRADE		
CONCENTRIC VENT KIT 3"					29571	\$222		
CONCENTRIC VENT KIT 2"					29570	\$222		
ARGO AMB MULTIPLE BOILER CONTROL (INCLUDES OUTDOOR RESET, PRIORITY OVERRIDE, LEAD BOILER RUN TIME ROTATION):								
AMB8A TO ALLOW STAGE FIRING OF UP TO 8 BOILERS					AMB8AU	\$1,000		
CONVERSION KIT NAT. TO LP UB90-50 (Series IV) 0' - 10,000'					550002631	\$77		
CONVERSION KIT NAT. TO LP UB90-75 (Series IV) 5,000' - 10,000'					550002629	\$77		
CONVERSION KIT NAT. TO LP UB90-75 (Series IV) 0' - 5,000'					550002630	\$77		
CONVERSION KIT NAT. TO LP UB90-100 (Series IV) 0' - 10,000'					550002700	\$77		

CONVERSION KIT LP TO NAT. UB90-50 (Series IV) 0' - 10,000'	550002635	\$77
CONVERSION KIT LP TO NAT. UB90-75 (Series IV) 0' - 10,000'	550002634	\$77
CONVERSION KIT LP TO NAT. UB90-100 (Series IV) 0' - 10,000'	550002701	\$77
2" CPVC 45° ELBOW	14631702	\$38
2" CPVC 90° ELBOW	240009663	\$27
2" CPVC TEE, SCHEDULE 80	240006819	\$37
2" CPVC COUPLING	240006822	\$24
FILL-TROL #110 FOR WATER BOILERS 150 MBH OR LESS	14624002	\$297
FILL-TROL #111 FOR WATER BOILERS OVER 150 MBH	14624003	\$400

UB90-100 SERIES IV - STANDARD EQUIPMENT

STANDARD EQUIPMENT:

- Boiler Control Module: HSI Integrated Boiler Control
- Combination Hydrolevel High Limit with LWCO with boiler water temperature reset feature
- Heat Exchanger: Cast Aluminum Heat Exchanger
- Combustion: Stainless Steel Premix Burner
- Induced Draft Blower with adjustable exhaust (front, right side or rear), Inducer Motor Assembly, includes 5' schedule 80 2" CPVC and CPVC Tee.
- Electrical: Junction Box, Transformer.
- Textured painted steel jacket.
- Other: Temperature/Pressure Gauge, 30 PSI Safety Relief Valve, Pressure Switch(es), Low Profile Condensate Trap and Air Vent

CUB SERIES

NATURAL OR PROPANE
 MODULATING 3:1
 SPACE HEATING ONLY & COMBI
 (CHIMNEY/SIDEWALL VENTED)

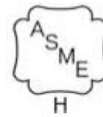

**DWB Combi Unit
 (CCB-150) Shown**

See IOM for dimensions
 on other models.

TOP

Width 17-23/32"

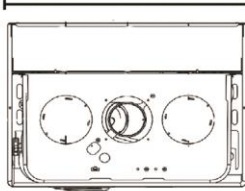

FRONT

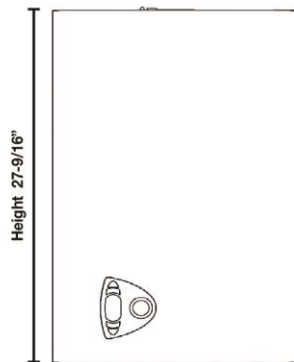

SIDE

Depth 13"

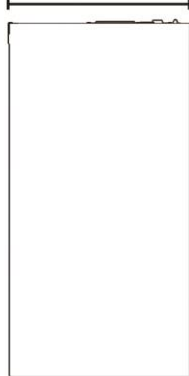

Primary/Secondary Manifold
 is Included



General Information (See IOM for complete instructions)

Clearances		Combustible Materials Required ⁽¹⁾	Service ^{(1) (2)}
		(1) Required distances measured from boiler. (2) Service, proper operation clearance recommendation.	Top
	Left Side	0" (0 cm)	1" (3 cm)
	Right Side	0" (0 cm)	1" (3 cm)
	Front	0" (0 cm)	1" (3 cm)
	Back	0" (0 cm)	0" (0 cm)
	Bottom	0" (0 cm)	12" (30 cm)
	Combustion Air/Vent Piping	0" (0 cm)	3/8" (1 cm)
	Vent Piping	6" (15 cm)	6" (15 cm)

Connections	
CCB-150	Return/Supply Water 1", Gas In 3/4" NPT, Domestic Hot Water Inlet/Outlet 3/4" NPT
CHB-100, CHB-130 & CHB-150	Return/Supply Water 1", Gas In 3/4" NPT, Indirect Tank 3/4" NPT
Electrical	120 Volts AC, 60 hertz, 1 phase, Less than 12 amps (15 amp circuit recommended)
Water Content	CCB-150/CHB-150 - .396 Gallons, CHB-130 - .317 Gallons, CHB-100 - .211 Gallons

Dimensions			
Model	"Width"	"Height"	"Depth"
CCB-150/CHB-150	17-23/32"	27-9/16"	13"
CHB-130	15-3/4"	27-9/16"	13"
CHB-100	15-3/4"	27-9/16"	13"

CUB SERIES CONTINUED

(NATURAL GAS - LESS SYSTEM PUMP, COMBI WITH DOMESTIC HOT WATER)

BOILER MODEL	ITEM NUMBER	TRADE PRICE	INPUT RATE (MBH)	HTG. CAP. (MBH)	AHRI NET (MBH)	AFUE RATING %	CHIMNEY CAT. I (Min. Size)	SIDE-WALL CAT. III	SHIP WGT.
CCB150	CCB0150000110	\$2,280	150	127	110	85.0	4"	3"	78

(NATURAL GAS - LESS SYSTEM PUMP, SPACE HEATING ONLY)

BOILER MODEL	ITEM NUMBER	TRADE PRICE	INPUT RATE (MBH)	HTG. CAP. (MBH)	AHRI NET (MBH)	AFUE RATING %	CHIMNEY CAT. I (Min. Size)	SIDE-WALL CAT. III	SHIP WGT.
CHB100	CHB0100000110	\$1,766	100	85	73	85.0	4"	3"	65
CHB130	CHB0130000110	\$1,957	130	110	96	85.0	4"	3"	69
CHB150	CHB0150000110	\$2,070	150	130	110	85.0	4"	3"	73

(USE PARTS MULTIPLIER FOR ALL OF THE FOLLOWING)

	PN	TRADE
NATURAL TO LP CONVERSION KIT (CCB150 & CHB-150)	FE3980C150	\$68
NATURAL TO LP CONVERSION KIT (CHB100)	FE3980C300	\$61
NATURAL TO LP CONVERSION KIT (CHB130)	FE3980B950	\$65
DIRECT VENT KIT	5612601	\$145
OUTSIDE AIR SENSOR	FE013018X0	\$30
DHW SENSOR KIT	550002958	\$55
FLOOR STAND KIT	240010266	\$599
CHB 100/130 FLOOR BASE KIT	550003450	\$280
CCB/CHB 150 FLOOR BASE KIT	550003451	\$280

CUB SERIES - STANDARD EQUIPMENT

CUB on Floor Base

STANDARD EQUIPMENT:

- Boiler Control Module: High Limit/Electronic Ignition Control.
- User Display Interface: Digital Temperature Display with diagnostics and programmable settings.
- Heat Exchanger: Copper Fin Tube.
(CCB-150 combination boiler includes a stainless steel brazed plate heat exchanger - 3.6 gpm at 70°F Temperature Rise, 6.3 gpm at 40°F Temperature Rise)
- Valve: 3-Way Water Diverting Valve.
- Combustion: Completely Installed and Wired Modulating Gas Control System (100% to 33%) with Stainless Steel Burners and Manifold consisting of: Automatic Modulating Gas Valve, Direct Spark Ignition Control, 100% Shut Off, Combination Spark Electrode/Flame Sensor.
- Safety: Pressure Switch (vent safety shutoff).
- Other: Assembled Boiler with Jacket, Induced Draft Fan, Combination Temperature/ Pressure Gauge, Circulator Pump, Gas Shut Off Valve and Field installed - 30lb. ASME Relief Valve.



SVB SERIES II
 NATURAL OR PROPANE
 HOT WATER BOILER
 INDUCED DRAFT
 (CHIMNEY/SIDEWALL VENTED)

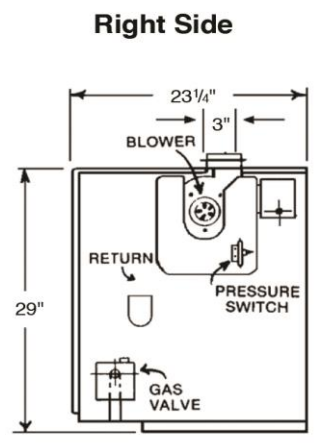
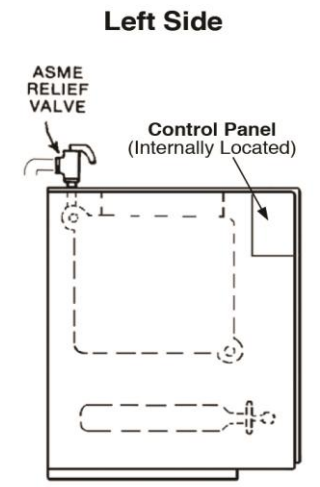
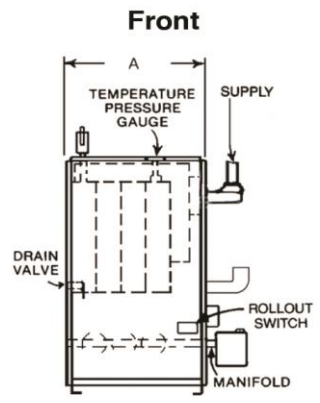
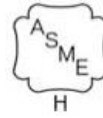

General Information (See IOM for complete instructions)

Clearances		Combustible Materials (Required) (1)
		(1) Required distances measured from boiler.
	Top	6" (152 mm)
	Rear	6" (152 mm)
	Right Side	8" (203 mm)
	Opposite Side	6" (152 mm)
	Front (Alcove)*	18" (457 mm)
	Flue Connector	6" (152 mm)

*Definition of Alcove is three sided space with no wall in front of boiler. ANSI standard for alcove is 18 inches from front of appliance to leading edge of side walls as shown in IOM.

Connections	Return/Supply Water	Gas In
All Models	1-1/4" NPT	1/2" NPT

Electrical
 120 Volts AC, 60 hertz, 1 phase, Less than 12 amps (15 amp circuit recommended)

Water Content
 SVB-2 - 1.75 Gallons, SVB-3 - 3.00 Gallons, SVB-4 - 4.25 Gallons, SVB-5 - 5.50 Gallons, SVB-6 - 6.75 Gallons, SVB-7 - 8.00 Gallons

Dimensions			
Model	A "Width"	B "Height"	C "Depth"
SVB-2	11"	29"	23-1/4"
SVB-3	14-1/4"	29"	23-1/4"
SVB-4	17-1/2"	29"	23-1/4"
SVB-5	20-3/4"	29"	23-1/4"
SVB-6	24"	29"	23-1/4"
SVB-7	27-1/4"	29"	23-1/4"

SVB SERIES II CONTINUED									
(NATURAL GAS - LESS SYSTEM PUMP)									
BOILER MODEL	ITEM NUMBER	TRADE PRICE	INPUT (MBH)	HTG. CAP. (MBH)	AHRI NET (MBH)	AFUE RATING %	CHIMNEY CAT. I Min. Size	SIDE-WALL CAT. III	SHIP WGT.
SVB-2	SVB204203100210	\$2,243	42.5	36	31	84.4	4"	3"	225
SVB-3	SVB307503100210	\$2,539	75.0	63	55	83.4	4"	3"	265
SVB-4	SVB411203100210	\$2,805	112.5	94	82	83.0	4"	3"	322
SVB-5	SVB515003100210	\$3,154	150.0	125	109	82.7	4"	3"	370
SVB-6	SVB618703100210	\$3,708	187.5	155	135	82.3	4"	4"	431
SVB-7	SVB722503100210	\$4,071	225.0	186	162	82.0	4"	4"	480
(NATURAL GAS - WITH TACO ECM SYSTEM PUMP)									
BOILER MODEL	ITEM NUMBER	TRADE PRICE	INPUT (MBH)	HTG. CAP. (MBH)	AHRI NET (MBH)	AFUE RATING %	CHIMNEY CAT. I Min. Size	SIDE-WALL CAT. III	SHIP WGT.
SVB-2	SVB204203140210	\$2,323	42.5	36	31	84.4	4"	3"	225
SVB-3	SVB307503140210	\$2,616	75.0	63	55	83.4	4"	3"	265
SVB-4	SVB411203140210	\$2,883	112.5	94	82	83.0	4"	3"	322
SVB-5	SVB515003140210	\$3,231	150.0	125	109	82.7	4"	3"	370
SVB-6	SVB618703140210	\$3,785	187.5	155	135	82.3	4"	4"	431
SVB-7	SVB722503140210	\$4,148	225.0	186	162	82.0	4"	4"	480
(NATURAL GAS, HIGH ALTITUDE - WITH TACO ECM SYSTEM PUMP)									
BOILER MODEL	ITEM NUMBER	TRADE PRICE	INPUT (MBH)	HTG. CAP. (MBH)	AHRI NET (MBH)	AFUE RATING %	CHIMNEY CAT. I Min. Size	SIDE-WALL CAT. III	SHIP WGT.
SVB-2	SVB204203142210	\$2,323	42.5	36	31	84.4	4"	3"	225
SVB-3	SVB307503142210	\$2,616	75.0	63	55	83.4	4"	3"	265
SVB-4	SVB411203142210	\$2,883	112.5	94	82	83.0	4"	3"	322
SVB-5	SVB515003142210	\$3,231	150.0	125	109	82.7	4"	3"	370
SVB-6	SVB618703142210	\$3,785	187.5	155	135	82.3	4"	4"	431
SVB-7	SVB722503142210	\$4,148	225.0	186	162	82.0	4"	4"	480
(NATURAL GAS - WITH GRUNDFOS SYSTEM PUMP)									
BOILER MODEL	ITEM NUMBER	TRADE PRICE	INPUT (MBH)	HTG. CAP. (MBH)	AHRI NET (MBH)	AFUE RATING %	CHIMNEY CAT. I Min. Size	SIDE-WALL CAT. III	SHIP WGT.
SVB-2	SVB204203120210	\$2,323	42.5	36	31	84.4	4"	3"	225
SVB-3	SVB307503120210	\$2,616	75.0	63	55	83.4	4"	3"	265
SVB-4	SVB411203120210	\$2,883	112.5	94	82	83.0	4"	3"	322
SVB-5	SVB515003120210	\$3,231	150.0	125	109	82.7	4"	3"	370
SVB-6	SVB618703120210	\$3,785	187.5	155	135	82.3	4"	4"	431
SVB-7	SVB722503120210	\$4,148	225.0	186	162	82.0	4"	4"	480
(NATURAL GAS, HIGH ALTITUDE - WITH GRUNDFOS SYSTEM PUMP)									
BOILER MODEL	ITEM NUMBER	TRADE PRICE	INPUT (MBH)	HTG. CAP. (MBH)	AHRI NET (MBH)	AFUE RATING %	CHIMNEY CAT. I Min. Size	SIDE-WALL CAT. III	SHIP WGT.
SVB-2	SVB204203122210	\$2,323	42.5	36	31	84.4	4"	3"	225
SVB-3	SVB307503122210	\$2,616	75.0	63	55	83.4	4"	3"	265
SVB-4	SVB411203122210	\$2,883	112.5	94	82	83.0	4"	3"	322
SVB-5	SVB515003122210	\$3,231	150.0	125	109	82.7	4"	3"	370
SVB-6	SVB618703122210	\$3,785	187.5	155	135	82.3	4"	4"	431
SVB-7	SVB722503122210	\$4,148	225.0	186	162	82.0	4"	4"	480

SVB SERIES II CONTINUED									
(NATURAL GAS - WITH B & G SYSTEM PUMP)									
BOILER MODEL	ITEM NUMBER	TRADE PRICE	INPUT (MBH)	HTG. CAP. (MBH)	AHRI NET (MBH)	AFUE RATING %	CHIMNEY CAT. I Min. Size	SIDE-WALL CAT. III	SHIP WGT.
SVB-2	SVB204203130210	\$2,323	42.5	36	31	84.4	4"	3"	225
SVB-3	SVB307503130210	\$2,616	75.0	63	55	83.4	4"	3"	265
SVB-4	SVB411203130210	\$2,883	112.5	94	82	83.0	4"	3"	322
SVB-5	SVB515003130210	\$3,231	150.0	125	109	82.7	4"	3"	370
SVB-6	SVB618703130210	\$3,785	187.5	155	135	82.3	4"	4"	431
SVB-7	SVB722503130210	\$4,148	225.0	186	162	82.0	4"	4"	480
(LP GAS - LESS SYSTEM PUMP)									
BOILER MODEL	ITEM NUMBER	TRADE PRICE	INPUT (MBH)	HTG. CAP. (MBH)	AHRI NET (MBH)	AFUE RATING %	CHIMNEY CAT. I Min. Size	SIDE-WALL CAT. III	SHIP WGT.
SVB-2	SVB204213100210	\$2,297	42.5	36	31	84.4	4"	3"	225
SVB-3	SVB307513100210	\$2,592	75.0	63	55	83.4	4"	3"	265
SVB-4	SVB411213100210	\$2,858	112.5	94	82	83.0	4"	3"	322
SVB-5	SVB515013100210	\$3,207	150.0	125	109	82.7	4"	3"	370
SVB-6	SVB618713100210	\$3,761	187.5	155	135	82.3	4"	4"	431
SVB-7	SVB722513100210	\$4,124	225.0	186	162	82.0	4"	4"	480
(LP GAS - WITH TACO ECM SYSTEM PUMP)									
BOILER MODEL	ITEM NUMBER	TRADE PRICE	INPUT (MBH)	HTG. CAP. (MBH)	AHRI NET (MBH)	AFUE RATING %	CHIMNEY CAT. I Min. Size	SIDE-WALL CAT. III	SHIP WGT.
SVB-2	SVB204213140210	\$2,377	42.5	36	31	84.4	4"	3"	225
SVB-3	SVB307513140210	\$2,669	75.0	63	55	83.4	4"	3"	265
SVB-4	SVB411213140210	\$2,936	112.5	94	82	83.0	4"	3"	322
SVB-5	SVB515013140210	\$3,284	150.0	125	109	82.7	4"	3"	370
SVB-6	SVB618713140210	\$3,838	187.5	155	135	82.3	4"	4"	431
SVB-7	SVB722513140210	\$4,201	225.0	186	162	82.0	4"	4"	480
(LP GAS - WITH GRUNDFOS SYSTEM PUMP)									
BOILER MODEL	ITEM NUMBER	TRADE PRICE	INPUT (MBH)	HTG. CAP. (MBH)	AHRI NET (MBH)	AFUE RATING %	CHIMNEY CAT. I Min. Size	SIDE-WALL CAT. III	SHIP WGT.
SVB-2	SVB204213120210	\$2,377	42.5	36	31	84.4	4"	3"	225
SVB-3	SVB307513120210	\$2,669	75.0	63	55	83.4	4"	3"	265
SVB-4	SVB411213120210	\$2,936	112.5	94	82	83.0	4"	3"	322
SVB-5	SVB515013120210	\$3,284	150.0	125	109	82.7	4"	3"	370
SVB-6	SVB618713120210	\$3,838	187.5	155	135	82.3	4"	4"	431
SVB-7	SVB722513120210	\$4,201	225.0	186	162	82.0	4"	4"	480
(LP GAS - WITH B & G SYSTEM PUMP)									
BOILER MODEL	ITEM NUMBER	TRADE PRICE	INPUT (MBH)	HTG. CAP. (MBH)	AHRI NET (MBH)	AFUE RATING %	CHIMNEY CAT. I Min. Size	SIDE-WALL CAT. III	SHIP WGT.
SVB-2	SVB204213130210	\$2,377	42.5	36	31	84.4	4"	3"	225
SVB-3	SVB307513130210	\$2,669	75.0	63	55	83.4	4"	3"	265
SVB-4	SVB411213130210	\$2,936	112.5	94	82	83.0	4"	3"	322
SVB-5	SVB515013130210	\$3,284	150.0	125	109	82.7	4"	3"	370
SVB-6	SVB618713130210	\$3,838	187.5	155	135	82.3	4"	4"	431
SVB-7	SVB722513130210	\$4,201	225.0	186	162	82.0	4"	4"	480

SVB SERIES II CONTINUED

(USE PARTS MULTIPLIER FOR ALL OF THE FOLLOWING)	PN	TRADE
NATURAL TO LP CONVERSION KIT (ALL SIZES)	550002722	\$84
LP TO NATURAL CONVERSION KIT (ALL SIZES)	43300660	\$92
COMBUSTIBLE FLOOR PLATE FOR ALL CAPACITIES	14614032	\$98
4" THIMBLE (SIMPSON #915295)	14629014	\$41
TJERNLUND VH-1-3" SIDE WALL VENT HOOD (SVB-2 TO SVB-5)	14629010	\$234
TJERNLUND VH-1-4" SIDE WALL VENT HOOD (SVB-6 & SVB-7))	14629011	\$279
FILL-TROL #110 FOR WATER BOILERS 150 MBH OR LESS	14624002	\$297
FILL-TROL #111 FOR WATER BOILERS OVER 150 MBH	14624003	\$400

SVB (Series II) - STANDARD EQUIPMENT**STANDARD EQUIPMENT:**

- Boiler Control Module: Recessed Honeywell Control (High Limit/Electronic Ignition Control).
- User Display Interface: Digital Temperature Display.
- Heat Exchanger: Cast Iron Sections with Cast Iron Push Nipples.
- Combustion: Completely Installed and Wired Gas Control System with Titanium Composite Burners and Manifold consisting of: Automatic Redundant Combination Gas Valve, 24 Volt Intermittent Pilot Control, Continuous Retry 100% Shut Off, Combination Pilot Burner/Electrode/Flame Sensor.
- Electrical: 24 Volt Transformer, Service Switch.
- Safety: Flame Roll-Out Safety Shut-Off (Fuse Link) and Pressure Switch (vent safety shutoff) with Spare Fuse Link included.
- Other: Assembled Boiler with Insulated Jacket, Induced Draft Fan, Combination Temperature/Pressure Gauge, Circulator Pump, 3/4" Drain Valve, 30lb. ASME Relief Valve.

MGB SERIES II & MGC SERIES

NATURAL OR PROPANE
HOT WATER BOILER
CHIMNEY VENTED
(PROTECTED CONTROLS)

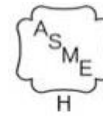

MGB Front

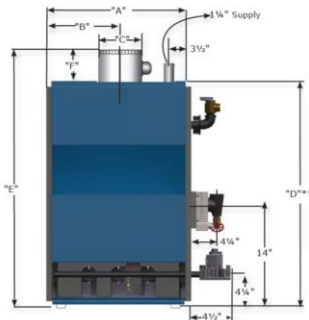

MGB Side

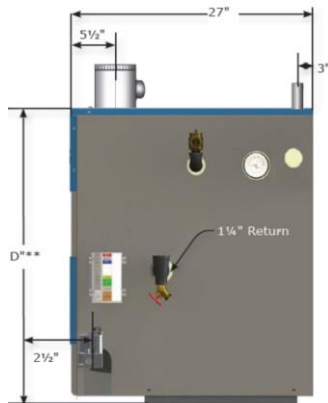

MGC Front



MGC Side



General Information (See IOM for complete instructions)

Clearances		Combustible Materials (Required) (1)	
		MGB II	MGC
(1) Required distances measured from boiler.	Top	18" (457 mm)	6" (152 mm)
	Front	Alcove*	18" (457 mm)
	Flue Connector	6" (152 mm)	6" (152 mm)
	Rear	4" (102 mm)	6" (152 mm)
	Control Side	9" (229 mm)	7" (178 mm)
	Other Side	3" (76 mm)	6" (152 mm)

*Definition of Alcove is three sided space with no wall in front of boiler. ANSI standard for alcove is 18 inches from front of appliance to leading edge of side walls as shown in IOM.

Connections	Return/Supply Water	Gas In
All Models	1-1/4" NPT	1/2" NPT
Electrical	120 Volts AC, 60 hertz, 1 phase, Less than 12 amps (15 amp circuit recommended)	
Water Content	50 - 2.4 Gallons, 75/100 - 4.0 Gallons, 125/150 - 5.6 Gallons, 170/200 - 7.2 Gallons, 262.5 - 12.7 Gallons, 299 - 14.4 Gallons	

Dimensions				
Model	A	B	C	D
MGB-50J	11-1/8"	4"	30-3/4"	36-1/4"
MGB-75J	15"	5"	30-3/4"	37-3/4"
MGB-100J	15"	6"	30-3/4"	37-1/4"
MGB-125J	18-7/8"	6"	30-3/4"	37-1/4"
MGB-150J	18-7/8"	7"	30-3/4"	37-3/4"
MGB-170J	22-3/4"	7"	30-3/4"	38-3/4"
MGB-200J	22-3/4"	8"	30-3/4"	38-3/4"
Model	A	C	D	E
MGC-8D/DP	27-1/2"	7"	36-3/8"	41-7/8"
MGC-9D/DP	30-3/4"	7"	36-3/8"	41-7/8"

(NATURAL GAS - LESS SYSTEM PUMP)									
BOILER MODEL	ITEM NUMBER	TRADE PRICE	INPUT (MBH)	HTG. CAP. (MBH)	AHRI NET (MBH)	AFUE RATING %	AIR CUSHION TANK	NO. OF BRNS.	SHIP WGT.
MGB-50J	MGB205003200210	\$2,100	50	52	37	83.5	15	1	205
MGB-75J	MGB307503200210	\$2,359	75	63	55	83.1	15	2	253
MGB-100J	MGB310003200210	\$2,441	100	83	72	83.0	30	2	253
MGB-125J	MGB412503200210	\$2,668	125	104	90	82.0	30	3	315
MGB-150J	MGB415003200210	\$2,756	150	124	108	83.0	30	3	315
MGB-170J	MGB517003200210	\$3,263	170	139	121	82.0	30	4	377
MGB-200J	MGB520003200210	\$3,449	200	165	143	82.0	30	4	377
MGC-8D	MGC826203200210	\$4,079	262.5	220	191	83.9	60	7	552
MGC-9D	MGC929903200210	\$4,692	299	251	218	83.7	60	8	616
(NATURAL GAS - WITH TACO ECM SYSTEM PUMP)									
BOILER MODEL	ITEM NUMBER	TRADE PRICE	INPUT (MBH)	HTG. CAP. (MBH)	AHRI NET (MBH)	AFUE RATING %	AIR CUSHION TANK	NO. OF BRNS.	SHIP WGT.
MGB-50J	MGB205003240210	\$2,178	50	52	37	83.5	15	1	205
MGB-75J	MGB307503240210	\$2,437	75	63	55	83.1	15	2	253
MGB-100J	MGB310003240210	\$2,518	100	83	72	83.0	30	2	253
MGB-125J	MGB412503240210	\$2,746	125	104	90	82.0	30	3	315
MGB-150J	MGB415003240210	\$2,834	150	124	108	83.0	30	3	315
MGB-170J	MGB517003240210	\$3,341	170	139	121	82.0	30	4	377
MGB-200J	MGB520003240210	\$3,526	200	165	143	82.0	30	4	377
MGC-8D	MGC826203240210	\$4,157	262.5	220	191.0	83.9	60	7	552
MGC-9D	MGC929903240210	\$4,770	299	251	218.0	83.7	60	8	616
(NATURAL GAS, HIGH ALTITUDE - WITH TACO ECM SYSTEM PUMP)									
BOILER MODEL	ITEM NUMBER	TRADE PRICE	INPUT (MBH)	HTG. CAP. (MBH)	AHRI NET (MBH)	AFUE RATING %	AIR CUSHION TANK	NO. OF BRNS.	SHIP WGT.
MGB-50J	MGB205003242210	\$2,178	50	52	37	83.5	15	1	205
MGB-75J	MGB307503242210	\$2,437	75	63	55	83.1	15	2	253
MGB-100J	MGB310003242210	\$2,518	100	83	72	83.0	30	2	253
MGB-125J	MGB412503242210	\$2,746	125	104	90	82.0	30	3	315
MGB-150J	MGB415003242210	\$2,834	150	124	108	83.0	30	3	315
MGB-170J	MGB517003242210	\$3,341	170	139	121	82.0	30	4	377
MGB-200J	MGB520003242210	\$3,526	200	165	143	82.0	30	4	377
MGC-8D	MGC826203242210	\$4,157	262.5	220	191.0	83.9	60	7	552
MGC-9D	MGC929903242210	\$4,770	299	251	218.0	83.7	60	8	616
(NATURAL GAS - WITH GRUNDFOS SYSTEM PUMP)									
BOILER MODEL	ITEM NUMBER	TRADE PRICE	INPUT (MBH)	HTG. CAP. (MBH)	AHRI NET (MBH)	AFUE RATING %	AIR CUSHION TANK	NO. OF BRNS.	SHIP WGT.
MGB-50J	MGB205003220210	\$2,178	50	52	37	83.5	15	1	205
MGB-75J	MGB307503220210	\$2,437	75	63	55	83.1	15	2	253
MGB-100J	MGB310003220210	\$2,518	100	83	72	83.0	30	2	253
MGB-125J	MGB412503220210	\$2,746	125	104	90	82.0	30	3	315
MGB-150J	MGB415003220210	\$2,834	150	124	108	83.0	30	3	315
MGB-170J	MGB517003220210	\$3,341	170	139	121	82.0	30	4	377
MGB-200J	MGB520003220210	\$3,526	200	165	143	82.0	30	4	377
MGC-8D	MGC826203220210	\$4,157	262.5	220	191.0	83.9	60	7	552
MGC-9D	MGC929903220210	\$4,770	299	251	218.0	83.7	60	8	616

(NATURAL GAS, HIGH ALTITUDE - WITH GRUNDFOS SYSTEM PUMP)

BOILER MODEL	ITEM NUMBER	TRADE PRICE	INPUT (MBH)	HTG. CAP. (MBH)	AHRI NET (MBH)	AFUE RATING %	AIR CUSHION TANK	NO. OF BRNS.	SHIP WGT.
MGB-50J	MGB205003222210	\$2,178	50	52	37	83.5	15	1	205
MGB-75J	MGB307503222210	\$2,437	75	63	55	83.1	15	2	253
MGB-100J	MGB310003222210	\$2,518	100	83	72	83.0	30	2	253
MGB-125J	MGB412503222210	\$2,746	125	104	90	82.0	30	3	315
MGB-150J	MGB415003222210	\$2,834	150	124	108	83.0	30	3	315
MGB-170J	MGB517003222210	\$3,341	170	139	121	82.0	30	4	377
MGB-200J	MGB520003222210	\$3,526	200	165	143	82.0	30	4	377

(NATURAL GAS - WITH B & G SYSTEM PUMP)

BOILER MODEL	ITEM NUMBER	TRADE PRICE	INPUT (MBH)	HTG. CAP. (MBH)	AHRI NET (MBH)	AFUE RATING %	AIR CUSHION TANK	NO. OF BRNS.	SHIP WGT.
MGB-50J	MGB205003230210	\$2,178	50	52	37	83.5	15	1	205
MGB-75J	MGB307503230210	\$2,437	75	63	55	83.1	15	2	253
MGB-100J	MGB310003230210	\$2,518	100	83	72	83.0	30	2	253
MGB-125J	MGB412503230210	\$2,746	125	104	90	82.0	30	3	315
MGB-150J	MGB415003230210	\$2,834	150	124	108	83.0	30	3	315
MGB-170J	MGB517003230210	\$3,341	170	139	121	82.0	30	4	377
MGB-200J	MGB520003230210	\$3,526	200	165	143	82.0	30	4	377

(LP GAS - WITH TACO ECM SYSTEM PUMP)

BOILER MODEL	ITEM NUMBER	TRADE PRICE	INPUT (MBH)	HTG. CAP. (MBH)	AHRI NET (MBH)	AFUE RATING %	AIR CUSHION TANK	NO. OF BRNS.	SHIP WGT.
MGB-50J	MGB205013240210	\$2,231	50	52	37	83.5	15	1	205
MGB-75J	MGB307513240210	\$2,490	75	63	55	83.1	15	2	253
MGB-100J	MGB310013240210	\$2,571	100	83	72	83.0	30	2	253
MGB-125J	MGB412513240210	\$2,799	125	104	90	82.0	30	3	315
MGB-150J	MGB415013240210	\$2,887	150	124	108	83.0	30	3	315
MGB-170J	MGB517013240210	\$3,394	170	139	121	82.0	30	4	377
MGB-200J	MGB520013240210	\$3,579	200	165	143	82.0	30	4	377

(LP GAS - WITH GRUNDFOS SYSTEM PUMP)

BOILER MODEL	ITEM NUMBER	TRADE PRICE	INPUT (MBH)	HTG. CAP. (MBH)	AHRI NET (MBH)	AFUE RATING %	AIR CUSHION TANK	NO. OF BRNS.	SHIP WGT.
MGB-50J	MGB205013220210	\$2,231	50	52	37	83.5	15	1	205
MGB-75J	MGB307513220210	\$2,490	75	63	55	83.1	15	2	253
MGB-100J	MGB310013220210	\$2,571	100	83	72	83.0	30	2	253
MGB-125J	MGB412513220210	\$2,799	125	104	90	82.0	30	3	315
MGB-150J	MGB415013220210	\$2,887	150	124	108	83.0	30	3	315
MGB-170J	MGB517013220210	\$3,394	170	139	121	82.0	30	4	377
MGB-200J	MGB520013220210	\$3,579	200	165	143	82.0	30	4	377

(LP GAS - WITH B & G SYSTEM PUMP)

BOILER MODEL	ITEM NUMBER	TRADE PRICE	INPUT (MBH)	HTG. CAP. (MBH)	AHRI NET (MBH)	AFUE RATING %	AIR CUSHION TANK	NO. OF BRNS.	SHIP WGT.
MGB-50J	MGB205013230210	\$2,231	50	52	37	83.5	15	1	205
MGB-75J	MGB307513230210	\$2,490	75	63	55	83.1	15	2	253
MGB-100J	MGB310013230210	\$2,571	100	83	72	83.0	30	2	253
MGB-125J	MGB412513230210	\$2,799	125	104	90	82.0	30	3	315
MGB-150J	MGB415013230210	\$2,887	150	124	108	83.0	30	3	315
MGB-170J	MGB517013230210	\$3,394	170	139	121	82.0	30	4	377
MGB-200J	MGB520013230210	\$3,579	200	165	143	82.0	30	4	377

(USE PARTS MULTIPLIER FOR ALL OF THE FOLLOWING)	PN	TRADE
COMBUSTIBLE FLOOR PLATE MGB-50J	325-2-8.01	\$58
COMBUSTIBLE FLOOR PLATE MGB-75J	325-2-8.02	\$227
COMBUSTIBLE FLOOR PLATE MBG-100J	325-2-8.02	\$227
COMBUSTIBLE FLOOR PLATE MGB-125J	325-2-8.03	\$249
COMBUSTIBLE FLOOR PLATE MGB-150J	325-2-8.03	\$249
COMBUSTIBLE FLOOR PLATE MGB-170J	325-2-8.04	\$249
COMBUSTIBLE FLOOR PLATE MGB-200J	325-2-8.04	\$249
COMBUSTIBLE FLOOR PLATE MGC-8D,8DP,9D,9DP	14614032	\$98
CONVERSION KIT NAT. TO LP MGB-50J	550002663	\$84
CONVERSION KIT NAT. TO LP MGB-75J	550002664	\$84
CONVERSION KIT NAT. TO LP MGB-100J	550002663	\$84
CONVERSION KIT NAT. TO LP MGB-125J	550002665	\$84
CONVERSION KIT NAT. TO LP MGB-150J	550002663	\$84
CONVERSION KIT NAT. TO LP MGB-170J	550002665	\$84
CONVERSION KIT NAT. TO LP MGB-200J	550002663	\$84
CONVERSION KIT NAT. TO LP MGC-8	43300728	\$61
CONVERSION KIT NAT. TO LP MGC-9	43300729	\$61
CONVERSION KIT LP TO NAT. MGB-50J	5611902	\$102
CONVERSION KIT LP TO NAT. MGB-75J	5611903	\$105
CONVERSION KIT LP TO NAT. MGB-100J	5611904	\$105
CONVERSION KIT LP TO NAT. MGB-125J	5611905	\$107
CONVERSION KIT LP TO NAT. MGB-150J	5611906	\$107
CONVERSION KIT LP TO NAT. MGB-170J	5611905	\$107
CONVERSION KIT LP TO NAT. MGB-200J	5611908	\$109
CONVERSION KIT LP TO NAT. MGC-8	43300636	\$133
CONVERSION KIT LP TO NAT. MGC-9	43300637	\$159
FILL-TROL #110 FOR WATER BOILERS 150 MBH OR LESS	14624002	\$297
FILL-TROL #111 FOR WATER BOILERS OVER 150 MBH	14624003	\$400

MGB SERIES II & MGC SERIES STANDARD EQUIPMENT

STANDARD EQUIPMENT:

- Boiler Control Module: Hydrolevel Fuel Smart Control (High Limit/LWCO)
- User Display Interface: Digital Temperature Display
- Heat Exchanger: Cast Iron Sections with Cast Iron Push Nipples.
- Combustion: Stainless Steel Main Gas Burners (MGB)/Titanium Composite Burners (MGC), Combination 24 Volt Gas Control (Includes: Automatic Gas Valve, Gas Pressure Regulator, Automatic Pilot, Safety Shutoff, Pilot Flow Adjustment, Pilot Filter), Intermittent Pilot Control, Continuous Retry, Combination Pilot Burner/Electrode/Flame Sensor.
- Safety: Spill Switch and Roll-Out Switch for safety (MGB)/Flame Roll-Out Safety Shut-Off (Fuse Link) (MGC), Automatic Vent Damper.
- Other: Insulated Boiler Jacket, Integral Draft Diverter, Combination Temperature/Pressure Gauge, Circulator Pump, 3/4" Drain Valve, 30lb. ASME Relief Valve.

PEG-E SERIES
 NATURAL OR PROPANE
 STEAM BOILER

15 psi
 MAWP

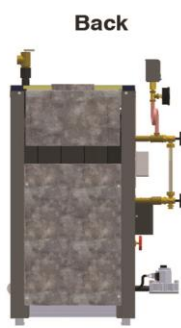
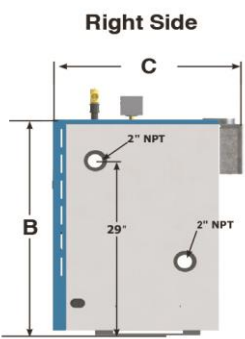
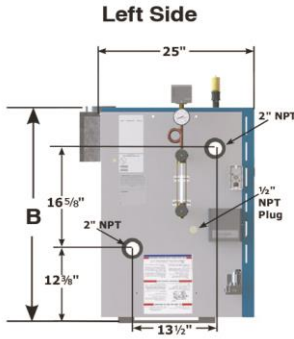
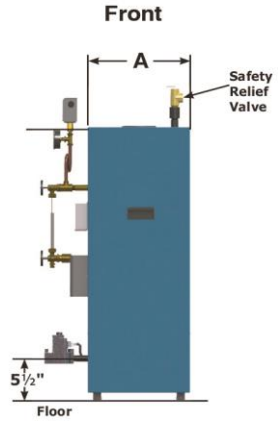
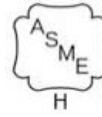

General Information (See IOM for complete instructions)

Clearances		Combustible Materials (Required) (1)
		(1) Required distances measured from boiler.
	Top	6" (152 mm)
	Left Side (Control Side)	7" (178 mm)
	Right Side	6" (152 mm)
	Front	Alcove*
	Back	6" (152 mm)
	Flue Connector	6" (152 mm)

*Definition of Alcove is three sided space with no wall in front of boiler. ANSI standard for alcove is 18 inches from front of appliance to leading edge of side walls as shown in IOM.

Connections	Supply	Return
		Two 2"

Electrical 120 Volts AC, 60 hertz, 1 phase, Less than 12 amps (15 amp circuit recommended)

Dimensions			
Model	A "Width"	B "Height"	C "Depth"
PEG075EID	10-7/8"	35-7/8"	28-3/8"
PEG112EID	14-1/8"	35-7/8"	28-3/8"
PEG150EID	17-3/8"	35-7/8"	29-3/8"
PEG187EID	20-5/8"	35-7/8"	30-3/8"
PEG225EID	23-7/8"	35-7/8"	30-3/8"
PEG262EID	27-1/8"	35-7/8"	30-3/8"
PEG299EID	30-3/8"	35-7/8"	30-3/8"

PEG-E SERIES CONTINUED									
(NATURAL GAS)									
BOILER MODEL	ITEM NUMBER	TRADE PRICE	INPUT (MBH)	HTG. CAP. (MBH)	AHRI NET (MBH)	AHRI NET SQ. FT. STEAM	AFUE RATING %	FLUE DIA.	SHIP WGT.
PEG075EID	PEG307503100510	\$2,984	75	62	47	195	82.2	5"	297
PEG112EID	PEG411203100510	\$3,295	112	93	70	292	82.4	5"	368
PEG150EID	PEG515003100510	\$3,586	150	125	94	391	82.6	6"	440
PEG187EID	PEG618703100510	\$3,860	187	156	117	488	82.8	7"	512
PEG225EID	PEG722503100510	\$4,533	225	188	141	587	83.0	7"	584
PEG262EID	PEG826203100510	\$4,864	263	219	164	685	83.2	7"	659
PEG299EID	PEG929903100510	\$5,270	299	250	188	782	83.4	7"	736
(LP GAS)									
BOILER MODEL	ITEM NUMBER	TRADE PRICE	INPUT (MBH)	HTG. CAP. (MBH)	AHRI NET (MBH)	AHRI NET SQ. FT. STEAM	AFUE RATING %	FLUE DIA.	SHIP WGT.
PEG075EID	PEG307513100510	\$3,038	75	62	47	195	82.2	5"	297
PEG112EID	PEG411213100510	\$3,351	112	93	70	292	82.4	5"	368
PEG150EID	PEG515013100510	\$3,641	150	125	94	391	82.6	6"	440
PEG187EID	PEG618713100510	\$3,915	187	156	117	488	82.8	7"	512
PEG225EID	PEG722513100510	\$4,589	225	188	141	587	83.0	7"	584
PEG262EID	PEG826213100510	\$4,918	263	219	164	685	83.2	7"	659
PEG299EID	PEG929913100510	\$5,325	299	250	188	782	83.4	7"	736
(USE PARTS MULTIPLIER FOR ALL OF THE FOLLOWING)						PN	TRADE		
CONVERSION KIT NAT. TO LP (3 - 5 SECTION)						550002702	\$58		
CONVERSION KIT NAT. TO LP (6 - 9 SECTION)						550002703	\$61		
CONVERSION KIT LP TO NAT. (3 - 5 SECTION)						550002704	\$64		
CONVERSION KIT LP TO NAT. (6 - 9 SECTION)						550002705	\$84		
MCDONNELL & MILLER WF-2U-24 ELECTRONIC WATER FEEDER						1630001	\$474		
COMBUSTIBLE FLOOR PLATE FOR ALL CAPACITIES						14614032	\$98		
PEG-E SERIES - STANDARD EQUIPMENT									
<u>STANDARD EQUIPMENT:</u>									
- Boiler Controls: LWCO (Probe Type), Pressure High Limit Control, Pressure Gauge, Gauge Glass.									
- Heat Exchanger: Cast Iron Sections with Cast Iron Push Nipples, (2) - 2" Supply Tappings; (2) - 2" Return Tappings.									
- Combustion: Stainless Steel Burners, Gas Valve, Intermittent Pilot Control with Continuous Retry and Combination Pilot Burner/Electrode Flame Sensor, Integral Draft Hood, Vent Damper.									
- Electrical: 24 Volt, 24VA Transformer.									
- Safety: Blocked Vent and Rollout Safety Switches, Pop Safety Valve.									
- Other: Crated Cast Iron Boiler with Insulated Jacket; Boiler Drain.									

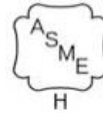
JE SERIESGAS FIRED
COMMERCIAL STEAM BOILER**JE SERIES STEAM
(STANDARD MODEL)**

BOILER MODEL	ITEM NUMBER	TRADE PRICE	INPUT BTU (MBH)	THERM. EFF.	OUT-PUT BTU (MBH)	NET AHRI RATINGS			NO. OF SECT.	SHIP WGT.
						STEAM PPF	STEAM SQ. FT.	STEAM BTU (MBH)		
JE300S	CBA030003101110	\$6,106	300	77%	233	1.33	729	175	4	1000
JE400S	CBA040003101110	\$6,870	400	77%	310	1.33	971	233	5	1200
JE500S	CBA050003101110	\$7,641	500	77%	388	1.33	1213	291	6	1400
JE600S	CBA060003101110	\$9,935	600	77%	465	1.33	1454	349	7	1600
JE700S	CBA070003101110	\$10,703	700	77%	543	1.33	1696	407	8	1800
JE800S	CBA080003101110	\$11,500	800	77%	620	1.33	1938	465	9	2000
JE900S	CBA090003101110	\$12,343	900	77%	698	1.33	2183	524	10	2200
JE1000S	CBA100003101110	\$13,109	1000	77%	775	1.33	2421	581	11	2400
JE1100S	CBA110003101110	\$15,463	1100	77%	853	1.33	2667	640	12	2600
JE1200S	CBA120003101110	\$16,229	1200	77%	930	1.33	2908	698	13	2900
JE1300S	CBA130003101110	\$17,443	1300	77%	1008	1.33	3150	756	14	3100
JE1400S	CBA140003101110	\$18,212	1400	77%	1085	1.33	3392	814	15	3300
JE1500S	CBA150003101110	\$18,997	1500	77%	1163	1.33	3633	872	16	3500

(CSD-1 GRAVITY RETURN SYSTEM)

BOILER MODEL	ITEM NUMBER	TRADE PRICE	INPUT BTU (MBH)	THERM. EFF.	OUT-PUT BTU (MBH)	NET AHRI RATINGS			NO. OF SECT.	SHIP WGT.
						STEAM PPF	STEAM SQ. FT.	STEAM BTU (MBH)		
JE300S	CBA030003103110	\$6,817	300	77%	233	1.33	729	175	4	1000
JE400S	CBA040003103110	\$7,581	400	77%	310	1.33	971	233	5	1200
JE500S	CBA050003103110	\$8,348	500	77%	388	1.33	1213	291	6	1400
JE600S	CBA060003103110	\$11,446	600	77%	465	1.33	1454	349	7	1600
JE700S	CBA070003103110	\$12,228	700	77%	543	1.33	1696	407	8	1800
JE800S	CBA080003103110	\$13,023	800	77%	620	1.33	1938	465	9	2000
JE900S	CBA090003103110	\$13,865	900	77%	698	1.33	2183	524	10	2200
JE1000S	CBA100003103110	\$14,628	1000	77%	775	1.33	2421	581	11	2400
JE1100S	CBA110003103110	\$17,288	1100	77%	853	1.33	2667	640	12	2600
JE1200S	CBA120003103110	\$18,053	1200	77%	930	1.33	2908	698	13	2900
JE1300S	CBA130003103110	\$19,264	1300	77%	1008	1.33	3150	756	14	3100
JE1400S	CBA140003103110	\$20,033	1400	77%	1085	1.33	3392	814	15	3300
JE1500S	CBA150003103110	\$20,816	1500	77%	1163	1.33	3633	872	16	3500

JE SERIES STEAM CONTINUED (CSD-1 BOILER FEED PUMP RETURN CONTROL)											
BOILER MODEL	ITEM NUMBER	TRADE PRICE	INPUT BTU (MBH)	THERM. EFF.	OUT-PUT (MBH)	NET AHRI RATINGS			NO. OF SECT.	SHIP WGT.	
						STEAM PPF	STEAM SQ. FT.	STEAM BTU (MBH)			
JE300S	CBA030003104110	\$7,546	300	77%	233	1.33	729	175	4	1000	
JE400S	CBA040003104110	\$8,310	400	77%	310	1.33	971	233	5	1200	
JE500S	CBA050003104110	\$9,078	500	77%	388	1.33	1213	291	6	1400	
JE600S	CBA060003104110	\$12,177	600	77%	465	1.33	1454	349	7	1600	
JE700S	CBA070003104110	\$12,957	700	77%	543	1.33	1696	407	8	1800	
JE800S	CBA080003104110	\$13,752	800	77%	620	1.33	1938	465	9	2000	
JE900S	CBA090003104110	\$14,594	900	77%	698	1.33	2183	524	10	2200	
JE1000S	CBA100003104110	\$15,357	1000	77%	775	1.33	2421	581	11	2400	
JE1100S	CBA110003104110	\$18,017	1100	77%	853	1.33	2667	640	12	2600	
JE1200S	CBA120003104110	\$18,783	1200	77%	930	1.33	2908	698	13	2900	
JE1300S	CBA130003104110	\$19,994	1300	77%	1008	1.33	3150	756	14	3100	
JE1400S	CBA140003104110	\$20,762	1400	77%	1085	1.33	3392	814	15	3300	
JE1500S	CBA150003104110	\$21,545	1500	77%	1163	1.33	3633	872	16	3500	
FOR ORDERING KNOCK DOWN OR ALA CARTE JE-COMPONENTS & OPTIONAL EQUIP.											
								PN	TRADE		
CAST IRON SECTIONS - RIGHT END (179 LBS.)								41154050U	\$686		
CAST IRON SECTIONS - LEFT END (182 LBS.)								41154051U	\$686		
CAST IRON SECTIONS - INTERMEDIATE (165 LBS.)								41154052U	\$600		
COMPONENT CARTON - 300								550002861U	\$1,826		
COMPONENT CARTON - 400								550002862U	\$1,934		
COMPONENT CARTON - 500								550002863U	\$2,030		
COMPONENT CARTON - 300 CSD-1								550002890U	\$2,132		
COMPONENT CARTON - 400 CSD-1								550002891U	\$2,240		
COMPONENT CARTON - 500 CSD-1								550002892U	\$2,335		
END PANEL CARTON - JACKET								550002871U	\$265		
END PANEL CARTON - BASE								550002860U	\$241		
STEAM TRIM - SA 1 (SIZES/MODELS: 300 -500)								41200061U	\$890		
STEAM TRIM - SA 2 (SIZES/MODELS: 600 - 700)								41200062U	\$904		
STEAM TRIM - SA 3 (SIZES/MODELS: 800 - 1400)								41200063U	\$928		
STEAM TRIM - SA 4 (SIZES/MODELS: 1500)								41200064U	\$937		
ACCESSORY CARTON - 300								550002877US	\$312		
ACCESSORY CARTON - 400								550002878US	\$368		
ACCESSORY CARTON - 500								550002867US	\$443		
ACCESSORY CARTON - 600								550002879US	\$501		
ACCESSORY CARTON - 700								550002880US	\$561		
ACCESSORY CARTON - 800								550002881US	\$650		
ACCESSORY CARTON - 900								550002882US	\$773		
ACCESSORY CARTON - 1000								550002868US	\$843		
ACCESSORY CARTON - 1100								550002883US	\$963		
ACCESSORY CARTON - 1200								550002884US	\$1,012		
ACCESSORY CARTON - 1300								550002885US	\$1,542		
ACCESSORY CARTON - 1400								550002886US	\$1,603		
ACCESSORY CARTON - 1500								550002869US	\$1,692		
CSD-1 STEAM TRIM - GRAVITY/CONDENSATE (ALL SIZES)								41257103U	\$405		
CSD-1 STEAM TRIM - FEED PUMP (ALL SIZES)								41257104U	\$1,135		
CSD-1 ACCESSORY CARTON - 300								550002893US	\$312		
CSD-1 ACCESSORY CARTON - 400								550002894US	\$368		
CSD-1 ACCESSORY CARTON - 500								550002895US	\$443		
CSD-1 ACCESSORY CARTON - 600								550002896US	\$1,000		
CSD-1 ACCESSORY CARTON - 700								550002897US	\$1,074		
CSD-1 ACCESSORY CARTON - 800								550002898US	\$1,139		
CSD-1 ACCESSORY CARTON - 900								550002899US	\$1,286		
CSD-1 ACCESSORY CARTON - 1000								550002900US	\$1,356		
CSD-1 ACCESSORY CARTON - 1100								550002901US	\$1,475		
CSD-1 ACCESSORY CARTON - 1200								550002902US	\$1,535		
CSD-1 ACCESSORY CARTON - 1300								550002903US	\$2,063		
CSD-1 ACCESSORY CARTON - 1400								550002904US	\$2,125		
CSD-1 ACCESSORY CARTON - 1500								550002905US	\$2,189		

JE SERIES STEAM CONTINUED		
(USE PARTS MULTIPLIER FOR ALL OF THE FOLLOWING)	PN	TRADE
STEAM MANUAL RESET PRESSURE CONTROL (L4079B1033)	14662311	\$271
M-M 47-2 LWCO & FEEDER (MODELS 300-1500)	1280001	\$1,218
STRAP ON OPERATING CONTROL (L6006C-1034)	14662313	\$163
LWCO, MAN RESET, CSD-1 APPROVED, SHT PROBE	240007388	\$216

JE SERIES STEAM - STANDARD EQUIPMENT

STANDARD EQUIPMENT:

JE Series Gas Fired Steam Boilers are low pressure, sectional, cast iron boilers manufactured in 15 heating sizes. Input range from 300,000 to 1,500,000 Btuh for use in larger sized residences, schools, churches, and commercial or industrial buildings. These boilers can be used in multiples to supply even larger loads. The JE Series Boiler is a modular design. Bases, Jackets and Drafthoods are designed in three modular sizes and all boilers are field assembled using a combination of one or more of these three modules. Boiler bases are preassembled at the factory with the gas valve, manifold, burners, and pilot installed. All drafthoods have a cleanout panel to provide easy access to flueways for inspection and cleaning. On-site boiler assembly is quick and easy with preassembled bases and easy section by section assembly procedures. The same assembly techniques are used on all sizes, so assemblers become familiar with the equipment and are able to reduce installation time and cost. Steam boilers are designed for use with a maximum working pressure of 15 psig. STANDARD EQUIPMENT - STEAM: (67 Low Water Cut-Off, PA404A Pressuretrol and Syphon Loop, Water Gauge Glass Set with Glass and Rods, Steam Gauge, Pop Safety Valve).

**JE - COMPONENTS & OPTIONAL EQUIPMENT
CSD-1 CONTROL REQUIREMENTS**

The optional CSD-1 controls modify the standard JE boiler on both the fuel train and the steam trim as follows:

STEAM BOILER WITH BOILER FEED PUMP RETURN SYSTEM

- Add SF-500 Hydrolevel Safeguard Manual Reset L.W.C.O.
- Add 150S-B-MD L.W.C.O. and Pump Control
- Delete 67D-1 L.W.C.O.
- Add L404L Manual Reset Pressure Control

STEAM BOILER WITH GRAVITY OR CONDENSATE PUMP RETURN SYSTEM

- Add SF-500 Hydrolevel Safeguard Manual Reset L.W.C.O.
- Add L404C Manual Reset Pressure Control

The SF-500 L.W.C.O. is the secondary L.W.C.O. to the 67D-1 L.W.C.O. furnished standard with the boiler.

FUEL TRAIN

Substitute CSD-1 fuel train(s) for standard which includes (per base): Intermittent Pilot Module (PT#1140007) control Stop w/alarm 1003-612A & (PT#1140008) Control CSD1 Lockout Board BD 1145-2 with manual reset; Independent Pilot Gas Line (Manual shut-off valve, Pressure regulator, Safety shut-off valve); Main Gas Line (Gas Valve, Two leak test cocks, Manual shut-off downstream of the main gas valve).

NOTES:

1. The JE-300 and JE-400 do not require fuel train modifications for CSD-1. The standard fuel train is furnished.
2. Control equipment is included to meet Utica's interpretation of CSD-1. Consult local authorities before the installation of the boiler. Additional controls, if required can be provided at an additional price.

TRIFIRE TRB SERIES

OIL 3-PASS
WATER BOILER

65 psi
MAWP

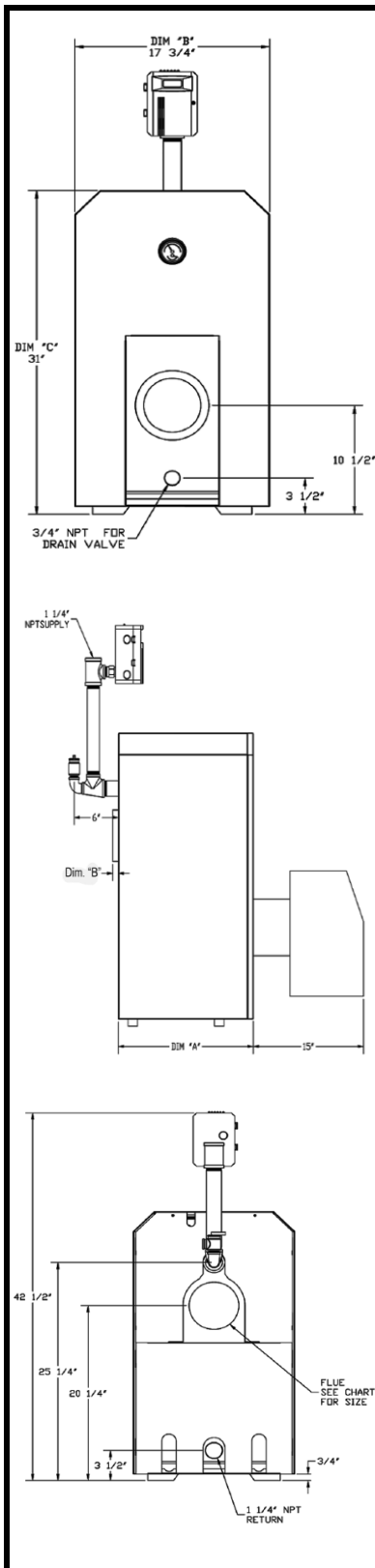
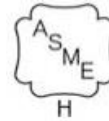

General Information (See IOM for complete instructions)

Clearances		Combustible Materials	Accessibility, Cleaning & Servicing
		(Required) (1)	(2)
(1) Required distances measured from boiler jacket or flue.	Top	12" (32 cm)	24" (61 cm)
	Right Side	2" (5 cm)	24" (61 cm)
	Left Side	2" (5 cm)	24" (61 cm)
(2) Accessibility, Cleaning & Servicing recommendation.	Floor	Combustible	N/A
	Front	17" (43 cm)	24" (61 cm)
	Back	9" (23 cm)	24" (61 cm)
	Flue	9" (23 cm)	9" (23 cm)
Connections	Return/Supply Water		
All Models	1-1/4" NPT		
Electrical	120 Volts AC, 60 hertz, 1 phase, Less than 12 amps (15 amp circuit recommended)		
Water Content	TRB4 - 3.6 Gallons, TRB5 - 4.3 Gallons, TRB6 - 5.1 Gallons, TRB7 - 5.9 Gallons		

Dimensions			
Model	A "Depth"	B "Width"	"C Height"
TRB4	18-3/8 (46 cm)	17-3/4" (45 cm)	31" (79 cm)
TRB5	21-5/8 (56 cm)	17-3/4" (45 cm)	31" (79 cm)
TRB6	24-7/8 (64 cm)	17-3/4" (45 cm)	31" (79 cm)
TRB7	28-1/8 (72 cm)	17-3/4" (45 cm)	31" (79 cm)

All TriFire boilers are factory equipped for chimney venting. For direct vent installations, order chimney vent boiler less burner, and order appropriate direct vent burner kit, direct vent pipe kit and direct vent termination.

TRIFIRE TRB SERIES CONTINUED										
(BECKETT BURNER - LESS PUMP)										
BOILER MODEL	ITEM NUMBER	TRADE PRICE	NO. OF SEC.	INPUT (MBH)	HTG. CAP. (MBH)	AHRI NET (MBH)	AFUE RATING %	CHIMNEY SIZE	FLUE DIA.	SHIP WGT.
TRB4075	TRB407530200210	\$2,538	4	105	91	79	86.0	8"x 8"x15'	5"	436
TRB4095	TRB409530200210	\$2,538	4	133	114	99	85.0		5"	436
TRB4110	TRB411030200210	\$2,538	4	154	132	115	84.0		5"	436
TRB5100	TRB510030200210	\$2,899	5	140	122	106	86.5		5"	496
TRB5115	TRB511530200210	\$2,899	5	161	139	121	85.0		5"	496
TRB5135	TRB513530200210	\$2,899	5	189	161	140	84.0		5"	496
TRB6130	TRB613030200210	\$3,060	6	182	159	138	86.5		5"	560
TRB6145	TRB614530200210	\$3,060	6	203	176	153	85.0		5"	560
TRB7165	TRB716530200210	\$3,501	7	231	201	175	86.0		6"	620
(BECKETT BURNER - WITH TACO ECM SYSTEM PUMP)										
BOILER MODEL	ITEM NUMBER	TRADE PRICE	NO. OF SEC.	INPUT (MBH)	HTG. CAP. (MBH)	AHRI NET (MBH)	AFUE RATING %	CHIMNEY SIZE	FLUE DIA.	SHIP WGT.
TRB4075	TRB407530240210	\$2,615	4	105	91	79	86.0	8"x 8"x15'	5"	436
TRB4095	TRB409530240210	\$2,615	4	133	114	99	85.0		5"	436
TRB4110	TRB411030240210	\$2,615	4	154	132	115	84.0		5"	436
TRB5100	TRB510030240210	\$2,976	5	140	122	106	86.5		5"	496
TRB5115	TRB511530240210	\$2,976	5	161	139	121	85.0		5"	496
TRB5135	TRB513530240210	\$2,976	5	189	161	140	84.0		5"	496
TRB6130	TRB613030240210	\$3,138	6	182	159	138	86.5		5"	560
TRB6145	TRB614530240210	\$3,138	6	203	176	153	85.0		5"	560
TRB7165	TRB716530240210	\$3,578	7	231	201	175	86.0		6"	620
(BECKETT BURNER - WITH GRUNDFOS SYSTEM PUMP)										
BOILER MODEL	ITEM NUMBER	TRADE PRICE	NO. OF SEC.	INPUT (MBH)	HTG. CAP. (MBH)	AHRI NET (MBH)	AFUE RATING %	CHIMNEY SIZE	FLUE DIA.	SHIP WGT.
TRB4075	TRB407530220210	\$2,615	4	105	91	79	86.0	8"x 8"x15'	5"	436
TRB4095	TRB409530220210	\$2,615	4	133	114	99	85.0		5"	436
TRB4110	TRB411030220210	\$2,615	4	154	132	115	84.0		5"	436
TRB5100	TRB510030220210	\$2,976	5	140	122	106	86.5		5"	496
TRB5115	TRB511530220210	\$2,976	5	161	139	121	85.0		5"	496
TRB5135	TRB513530220210	\$2,976	5	189	161	140	84.0		5"	496
TRB6130	TRB613030220210	\$3,138	6	182	159	138	86.5		5"	560
TRB6145	TRB614530220210	\$3,138	6	203	176	153	85.0		5"	560
TRB7165	TRB716530220210	\$3,578	7	231	201	175	86.0		6"	620
(LESS BURNER - WITH TACO ECM SYSTEM PUMP)										
BOILER MODEL	ITEM NUMBER	TRADE PRICE	NO. OF SEC.	INPUT (MBH)	HTG. CAP. (MBH)	AHRI NET (MBH)	AFUE RATING %	CHIMNEY SIZE	FLUE DIA.	SHIP WGT.
TRB4110	TRB411020240210	\$1,970	4	154	132	115	84.0	8"x8"x15'	5"	436
TRB5135	TRB513520240210	\$2,294	5	189	161	140	84.0		5"	496
TRB6165	TRB616520240210	\$2,522	6	231	198	172	84.0		5"	560
TRB7190	TRB719020240210	\$2,903	7	266	228	198	84.0	8"x8"x20'	6"	620
(LESS BURNER - WITH GRUNDFOS SYSTEM PUMP)										
BOILER MODEL	ITEM NUMBER	TRADE PRICE	NO. OF SEC.	INPUT (MBH)	HTG. CAP. (MBH)	AHRI NET (MBH)	AFUE RATING %	CHIMNEY SIZE	FLUE DIA.	SHIP WGT.
TRB4110	TRB411020220206	\$1,970	4	154	132	115	84.0	8"x8"x15'	5"	436
TRB5135	TRB513520220206	\$2,294	5	189	161	140	84.0		5"	496
TRB6165	TRB616520220206	\$2,522	6	231	198	172	84.0		5"	560
TRB7190	TRB719020220206	\$2,903	7	266	228	198	84.0	8"x8"x20'	6"	620

TRIFIRE TRB SERIES CONTINUED

(LESS BURNER - LESS PUMP)

BOILER MODEL	ITEM NUMBER	TRADE PRICE	NO. OF SEC.	INPUT (MBH)	HTG. CAP. (MBH)	AHRI NET (MBH)	AFUE RATING %	CHIMNEY SIZE	FLUE DIA.	SHIP WGT.
TRB4110	TRB411020200210	\$1,892	4	154	132	115	84.0	8"x8"x15'	5"	436
TRB5135	TRB513520200210	\$2,216	5	189	161	140	84.0		5"	496
TRB6165	TRB616520200210	\$2,445	6	231	198	172	84.0		5"	560
TRB7190	TRB719020200210	\$2,825	7	266	228	198	84.0	8"x8"x20'	6"	620

(RIELLO BURNER - LESS PUMP)

BOILER MODEL	ITEM NUMBER	TRADE PRICE	NO. OF SEC.	INPUT (MBH)	HTG. CAP. (MBH)	AHRI NET (MBH)	AFUE RATING %	CHIMNEY SIZE	FLUE DIA.	SHIP WGT.	
TRB4075	TRB407550200210	\$2,654	4	105	91	79	86.0	8" x 8"x15'	5"	436	
TRB4095	TRB409550200210	\$2,654	4	133	114	99	85.0		5"	436	
TRB4110	TRB411050200210	\$2,654	4	154	132	115	84.0		5"	436	
TRB5100	TRB510050200210	\$3,061	5	140	122	106	86.5		5"	496	
TRB5115	TRB511550200210	\$3,061	5	161	139	121	85.0		5"	496	
TRB5135	TRB513550200210	\$3,061	5	189	161	140	84.0		5"	496	
TRB6130	TRB613050200210	\$3,222	6	182	159	138	86.5		5"	560	
TRB6145	TRB614550200210	\$3,222	6	203	176	153	85.0		5"	560	
TRB6165	TRB616550200210	\$3,515	6	231	198	172	84.0		5"	560	
TRB7165	TRB716550200210	\$3,501	7	231	201	175	86.0		6"	620	
TRB7180	TRB718050200210	\$3,897	7	252	217	189	85.0		6"	620	
TRB7190	TRB719050200210	\$3,897	7	266	228	198	84.0		8" x 8"x20'	6"	620

(RIELLO BURNER - WITH TACO ECM SYSTEM PUMP)

BOILER MODEL	ITEM NUMBER	TRADE PRICE	NO. OF SEC.	INPUT (MBH)	HTG. CAP. (MBH)	AHRI NET (MBH)	AFUE RATING %	CHIMNEY SIZE	FLUE DIA.	SHIP WGT.	
TRB4075	TRB407550240210	\$2,732	4	105	91	79	86.0	8" x 8"x15'	5"	436	
TRB4095	TRB409550240210	\$2,732	4	133	114	99	85.0		5"	436	
TRB4110	TRB411050240210	\$2,732	4	154	132	115	84.0		5"	436	
TRB5100	TRB510050240210	\$3,139	5	140	122	106	86.5		5"	496	
TRB5115	TRB511550240210	\$3,139	5	161	139	121	85.0		5"	496	
TRB5135	TRB513550240210	\$3,139	5	189	161	140	84.0		5"	496	
TRB6130	TRB613050240210	\$3,300	6	182	159	138	86.5		5"	560	
TRB6145	TRB614550240210	\$3,300	6	203	176	153	85.0		5"	560	
TRB6165	TRB616550240210	\$3,592	6	231	198	172	84.0		5"	560	
TRB7165	TRB716550240210	\$3,578	7	231	201	175	86.0		6"	620	
TRB7180	TRB718050240210	\$3,975	7	252	217	189	85.0		6"	620	
TRB7190	TRB719050240210	\$3,975	7	266	228	198	84.0		8" x 8"x20'	6"	620

TRIFIRE TRB SERIES CONTINUED										
(RIELLO BURNER - WITH GRUNDFOS SYSTEM PUMP)										
BOILER MODEL	ITEM NUMBER	TRADE PRICE	NO. OF SEC.	INPUT (MBH)	HTG. CAP. (MBH)	AHRI NET (MBH)	AFUE RATING %	CHIMNEY SIZE	FLUE DIA.	SHIP WGT.
TRB4075	TRB407550220210	\$2,732	4	105	91	79	86.0	8"x 8"x15'	5"	436
TRB4095	TRB409550220210	\$2,732	4	133	114	99	85.0		5"	436
TRB4110	TRB411050220210	\$2,732	4	154	132	115	84.0		5"	436
TRB5100	TRB510050220210	\$3,139	5	140	122	106	86.5		5"	496
TRB5115	TRB511550220210	\$3,139	5	161	139	121	85.0		5"	496
TRB5135	TRB513550220210	\$3,139	5	189	161	140	84.0		5"	496
TRB6130	TRB613050220210	\$3,300	6	182	159	138	86.5		5"	560
TRB6145	TRB614550220210	\$3,300	6	203	176	153	85.0		5"	560
TRB6165	TRB616550220210	\$3,592	6	231	198	172	84.0		5"	560
TRB7165	TRB716550220210	\$3,578	7	231	201	175	86.0		6"	620
TRB7180	TRB718050220210	\$3,975	7	252	217	189	85.0	6"	620	
TRB7190	TRB719050220210	\$3,975	7	266	228	198	84.0	8"x 8"x20'	6"	620
TRIFIRE TRB SERIES - VENTING OPTIONS/ADD. EQUIPMENT							PN	TRADE		
36" RISER TERMINATION							29231U	\$1,186		
STANDARD TERMINATION							28972U	\$506		
4" ID X 10 FT DIRECT VENT PIPE KIT (SELECT TERMINATION)							550003419U	\$566		
4" ID X 15 FT DIRECT VENT PIPE KIT (SELECT TERMINATION)							550003420U	\$678		
4" ID X 20 FT DIRECT VENT PIPE KIT (SELECT TERMINATION)							550003421U	\$799		
SELECT DIRECT VENT BURNER FROM REPLACEMENT BURNERS LISTED BELOW										
(USE PARTS MULTIPLIER FOR ALL OF THE FOLLOWING)							PN	TRADE		
KIT, HIGH LIMIT MANUAL RESET L4006E1109 WITH PLUG IN HARNESS							550001929	\$225		
FILL-TROL FOR WATER BOILERS 150 MBH OR LESS							14624002	\$297		
FILL-TROL FOR WATER BOILERS OVER 150 MBH							14624003	\$400		
REPLACEMENT BURNERS										
DESCRIPTION						MODEL	PN	TRADE		
Oil Burner - Beckett Chimney Vent w/o Cover Model AFG except 5115 & 5135 use Model NX						4075	240007232U	\$633		
						4095	240009385U	\$633		
						4110	240009386U	\$633		
						5100	240007233U	\$670		
						5115	240009387U	\$670		
						5135	240009388U	\$713		
						6130	240007234U	\$604		
						6145	240009389U	\$604		
						7165	240007235U	\$661		
Oil Burner - Same as above w/Cover						4075	240007144U	\$676		
						4095	240009377U	\$676		
						4110	240009378U	\$676		
						5100	240007145U	\$713		
						5115	240009379U	\$713		
						5135	240009380U	\$713		
						6130	240007146U	\$649		
						6145	240009381U	\$649		
7165	240007183U	\$704								
Oil Burner - Beckett Direct Vent Model NX						4075	240007531U	\$808		
						4095	240009393U	\$808		
						5100	240007532U	\$842		
						5115	240009395U	\$842		
						5135	240009396U	\$842		
6130	240007533U	\$779								

TRIFIRE TRB SERIES CONTINUED

Oil Burner - Riello Chimney Vent Model 40F	4075	240007502U	\$745
	4095	240009399U	\$745
	4110	240009400U	\$745
	5100	240007503U	\$829
	5115	240009401U	\$829
	5135	550002638U	\$833
	6130	550002639U	\$766
	6145	550002640U	\$766
	6165	240009404U	\$1,050
	7165	240007505U	\$762
	7180	550002641U	\$1,055
	7190	240009406U	\$1,050

REPLACEMENT BURNERS

Oil Burner - Riello Direct Vent Model 40BF	4075	240007528U	\$1,088
	4095	240009407U	\$1,088
	4110	240009408U	\$1,088
	5100	240007529U	\$1,170
	5115	240009409U	\$1,170
	5135	240009410U	\$1,170
	6130	240007530U	\$1,104

Oil Burner - Carlin Chimney Vent EZ-LF	4075	240010357U	\$682
	4095		
	4110		
	5100		
	5115		
	5135		

TRIFIRE TRB - STANDARD EQUIPMENT

STANDARD EQUIPMENT:

- Boiler Control Module: Hydrolevel Fuel Smart HydroStat Control - combination Low Water Cut Off with boiler temperature reset and circulator control.
- User Display Interface: Digital display with easy to set dial-type limit settings.
- Heat Exchanger: High efficiency, cast iron, 3-pass design with reversible swing door and target wall. Efficiency baffles/liner by model.
- Combustion: Oil burner, flexible oil line.
- Electrical: Wiring harness with Molex connectors. Burner with electrical plug in cord.
- Other: Temperature/pressure gauge, 3/4" ASME relief valve, drain valve, textured painted steel jacket, barometric draft control

STARFIRE SFH-IV SERIES
OIL CHIMNEY VENT
WATER BOILER

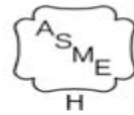

Front View

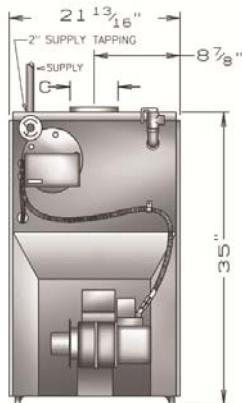

General Information (See IOM for complete instructions)

Clearances		Combustible Materials (Required) (1)
(1) Required distances measured from boiler.	Top	24" (610 mm)
	Front	24" (610 mm)
	Flue Connector	9" (229 mm)
	Rear	6" (152 mm)
	Sides	6" (152 mm)
Connections	Supply Tapping - 2", Return Tapping 1-1/2" NPT, Oil Line 3/8" O.D. copper tubing for runs of 50 feet or less, and 1/2" O.D. for longer runs.	
All Models		
Electrical	120 Volts AC, 60 hertz, 1 phase, Less than 12 amps (15 amp circuit recommended)	
Water Content	SFH3 - 10.5 Gallons, SFH4 - 13.5 Gallons, SFH5 - 16.5 Gallons, SFH6 - 19.5 Gallons	

Side View

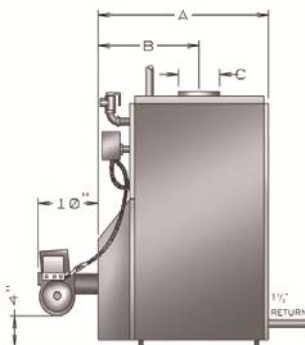

Model	Input Rate G.P.H.	Tankless Heater Number	Tankless Heater Cap. Intermittent
SFH-3085WT	0.85	T3	3
SFH-3100WT	1.00	T3	3.25
SFH-4100WT	1.00	T4	3.25
SFH-4125WT	1.25	T4	3.75
SFH-4145WT	1.45	T4	4
SFH-5160WT	1.60	T4	4
SFH-5185WT	1.85	T4	4.25
SFH-6175WT	1.75	T4	4.25
SFH-6210WT	2.10	T4	4.5

Dimensions

Number of Sections	A (Depth of Flush Jacket)	B (Front of Jacket to Center Line of Flue)	C (Flue Outlet Diam.)
3	17-7/8"	11-1/4"	6"
4	21-1/2"	12-5/8"	6"
5	25-1/8"	14-1/4"	7"
6	29-1/4"	15-15/16"	8"

BECKETT BURNER - CHIMNEY VENTED - CAST OVER

LESS PUMP

BOILER MODEL	ITEM NUMBER	TRADE PRICE	NO. OF SEC.	INPUT (MBH)	HTG. CAP. (MBH)	AHRI NET (MBH)	FIRING RATE G.P.H.	AFUE RATING %	SHIP WGT.
SFH-3085W	SFH308530200410	\$3,353	3	119	103	90	0.85	85.0	534
SFH-3100W	SFH310030200410	\$3,353	3	140	119	103	1.00	84.0	534
SFH-4100W	SFH410030200410	\$3,843	4	140	122	106	1.00	86.0	668
SFH-4125W	SFH412530200410	\$3,843	4	175	151	131	1.25	85.0	668
SFH-4145W	SFH414530200410	\$3,843	4	203	173	150	1.45	84.0	668
SFH-5160W	SFH516030200410	\$4,370	5	224	193	168	1.60	85.0	781
SFH-5185W	SFH518530200410	\$4,370	5	259	221	192	1.85	84.0	781
SFH-6175W	SFH617530200410	\$4,786	6	245	212	184	1.75	85.0	901
SFH-6210W	SFH621030200410	\$4,786	6	294	252	219	2.10	84.0	901

TACO ECM SYSTEM PUMP

BOILER MODEL	ITEM NUMBER	TRADE PRICE	NO. OF SEC.	INPUT (MBH)	HTG. CAP. (MBH)	AHRI NET (MBH)	FIRING RATE G.P.H.	AFUE RATING %	SHIP WGT.
SFH-3085W	SFH308530240410	\$3,431	3	119	103	90	0.85	85.0	534
SFH-3100W	SFH310030240410	\$3,431	3	140	119	103	1.00	84.0	534
SFH-4100W	SFH410030240410	\$3,922	4	140	122	106	1.00	86.0	668
SFH-4125W	SFH412530240410	\$3,922	4	175	151	131	1.25	85.0	668
SFH-4145W	SFH414530240410	\$3,922	4	203	173	150	1.45	84.0	668
SFH-5160W	SFH516030240410	\$4,448	5	224	193	168	1.60	85.0	781
SFH-5185W	SFH518530240410	\$4,448	5	259	221	192	1.85	84.0	781
SFH-6175W	SFH617530240410	\$4,864	6	245	212	184	1.75	85.0	901
SFH-6210W	SFH621030240410	\$4,862	6	294	252	219	2.10	84.0	901

GRUNDFOS SYSTEM PUMP

BOILER MODEL	ITEM NUMBER	TRADE PRICE	NO. OF SEC.	INPUT (MBH)	HTG. CAP. (MBH)	AHRI NET (MBH)	FIRING RATE G.P.H.	AFUE RATING %	SHIP WGT.
SFH-3085W	SFH308530220410	\$3,431	3	119	103	90	0.85	85.0	534
SFH-3100W	SFH310030220410	\$3,431	3	140	119	103	1.00	84.0	534
SFH-4100W	SFH410030220410	\$3,922	4	140	122	106	1.00	86.0	668
SFH-4125W	SFH412530220410	\$3,922	4	175	151	131	1.25	85.0	668
SFH-4145W	SFH414530220410	\$3,922	4	203	173	150	1.45	84.0	668
SFH-5160W	SFH516030220410	\$4,448	5	224	193	168	1.60	85.0	781
SFH-5185W	SFH518530220410	\$4,448	5	259	221	192	1.85	84.0	781
SFH-6175W	SFH617530220410	\$4,864	6	245	212	184	1.75	85.0	901
SFH-6210W	SFH621030220410	\$4,864	6	294	252	219	2.10	84.0	901

BECKETT BURNER - CHIMNEY VENTED - WITH TANKLESS COVER PLATE

LESS PUMP

BOILER MODEL	ITEM NUMBER	TRADE PRICE	NO. OF SEC.	INPUT (MBH)	HTG. CAP. (MBH)	AHRI NET (MBH)	FIRING RATE G.P.H.	AFUE RATING %	SHIP WGT.
SFH-3085W	SFH308531200410	\$3,477	3	119	103	90	0.85	85.0	534
SFH-3100W	SFH310031200410	\$3,477	3	140	119	103	1.00	84.0	534
SFH-4100W	SFH410031200410	\$3,980	4	140	122	106	1.00	86.0	668
SFH-4125W	SFH412531200410	\$3,980	4	175	151	131	1.25	85.0	668
SFH-4145W	SFH414531200410	\$3,980	4	203	173	150	1.45	84.0	668
SFH-5160W	SFH516031200410	\$4,516	5	224	193	168	1.60	85.0	781
SFH-5185W	SFH518531200410	\$4,516	5	259	221	192	1.85	84.0	781
SFH-6175W	SFH617531200410	\$4,941	6	245	212	184	1.75	85.0	901
SFH-6210W	SFH621031200410	\$4,941	6	294	252	219	2.10	84.0	901

TACO ECM SYSTEM PUMP

BOILER MODEL	ITEM NUMBER	TRADE PRICE	NO. OF SEC.	INPUT (MBH)	HTG. CAP. (MBH)	AHRI NET (MBH)	FIRING RATE G.P.H.	AFUE RATING %	SHIP WGT.
SFH-3085W	SFH308531240410	\$3,557	3	119	103	90	0.85	85.0	534
SFH-3100W	SFH310031240410	\$3,557	3	140	119	103	1.00	84.0	534
SFH-4100W	SFH410031240410	\$4,059	4	140	122	106	1.00	86.0	668
SFH-4125W	SFH412531240410	\$4,059	4	175	151	131	1.25	85.0	668
SFH-4145W	SFH414531240410	\$4,059	4	203	173	150	1.45	84.0	668
SFH-5160W	SFH516031240410	\$4,595	5	224	193	168	1.60	85.0	781
SFH-5185W	SFH518531240410	\$4,595	5	259	221	192	1.85	84.0	781
SFH-6175W	SFH617531240410	\$5,019	6	245	212	184	1.75	85.0	901
SFH-6210W	SFH621031240410	\$5,019	6	294	252	219	2.10	84.0	901

GRUNDFOS SYSTEM PUMP

BOILER MODEL	ITEM NUMBER	TRADE PRICE	NO. OF SEC.	INPUT (MBH)	HTG. CAP. (MBH)	AHRI NET (MBH)	FIRING RATE G.P.H.	AFUE RATING %	SHIP WGT.
SFH-3085W	SFH308531220410	\$3,557	3	119	103	90	0.85	85.0	534
SFH-3100W	SFH310031220410	\$3,557	3	140	119	103	1.00	84.0	534
SFH-4100W	SFH410031220410	\$4,059	4	140	122	106	1.00	86.0	668
SFH-4125W	SFH412531220410	\$4,059	4	175	151	131	1.25	85.0	668
SFH-4145W	SFH414531220410	\$4,059	4	203	173	150	1.45	84.0	668
SFH-5160W	SFH516031220410	\$4,595	5	224	193	168	1.60	85.0	781
SFH-5185W	SFH518531220410	\$4,595	5	259	221	192	1.85	84.0	781
SFH-6175W	SFH617531220410	\$5,019	6	245	212	184	1.75	85.0	901
SFH-6210W	SFH621031220410	\$5,019	6	294	252	219	2.10	84.0	901

BECKETT BURNER - CHIMNEY VENTED - WITH TANKLESS COIL

LESS PUMP

BOILER MODEL	ITEM NUMBER	TRADE PRICE	NO. OF SEC.	INPUT (MBH)	HTG. CAP. (MBH)	AHRI NET (MBH)	FIRING RATE G.P.H.	AFUE RATING %	SHIP WGT.
SFH-3085WT	SFH308532200410	\$3,632	3	119	103	90	0.85	85.0	534
SFH-3100WT	SFH310032200410	\$3,632	3	140	119	103	1.00	84.0	534
SFH-4100WT	SFH410032200410	\$4,178	4	140	122	106	1.00	86.0	668
SFH-4125WT	SFH412532200410	\$4,178	4	175	151	131	1.25	85.0	668
SFH-4145WT	SFH414532200410	\$4,178	4	203	173	150	1.45	84.0	668
SFH-5160WT	SFH516032200410	\$4,663	5	224	193	168	1.60	85.0	781
SFH-5185WT	SFH518532200410	\$4,663	5	259	221	192	1.85	84.0	781
SFH-6175WT	SFH617532200410	\$5,073	6	245	212	184	1.75	85.0	901
SFH-6210WT	SFH621032200410	\$5,073	6	294	252	219	2.10	84.0	901

TACO ECM SYSTEM PUMP

BOILER MODEL	ITEM NUMBER	TRADE PRICE	NO. OF SEC.	INPUT (MBH)	HTG. CAP. (MBH)	AHRI NET (MBH)	FIRING RATE G.P.H.	AFUE RATING %	SHIP WGT.
SFH-3085WT	SFH308532240410	\$3,711	3	119	103	90	0.85	85.0	534
SFH-3100WT	SFH310032240410	\$3,711	3	140	119	103	1.00	84.0	534
SFH-4100WT	SFH410032240410	\$4,256	4	140	122	106	1.00	86.0	668
SFH-4125WT	SFH412532240410	\$4,256	4	175	151	131	1.25	85.0	668
SFH-4145WT	SFH414532240410	\$4,256	4	203	173	150	1.45	84.0	668
SFH-5160WT	SFH516032240410	\$4,742	5	224	193	168	1.60	85.0	781
SFH-5185WT	SFH518532240410	\$4,742	5	259	221	192	1.85	84.0	781
SFH-6175WT	SFH617532240410	\$5,152	6	245	212	184	1.75	85.0	901
SFH-6210WT	SFH621032240410	\$5,152	6	294	252	219	2.10	84.0	901

GRUNDFOS SYSTEM PUMP

BOILER MODEL	ITEM NUMBER	TRADE PRICE	NO. OF SEC.	INPUT (MBH)	HTG. CAP. (MBH)	AHRI NET (MBH)	FIRING RATE G.P.H.	AFUE RATING %	SHIP WGT.
SFH-3085WT	SFH308532220410	\$3,711	3	119	103	90	0.85	85.0	534
SFH-3100WT	SFH310032220410	\$3,711	3	140	119	103	1.00	84.0	534
SFH-4100WT	SFH410032220410	\$4,256	4	140	122	106	1.00	86.0	668
SFH-4125WT	SFH412532220410	\$4,256	4	175	151	131	1.25	85.0	668
SFH-4145WT	SFH414532220410	\$4,256	4	203	173	150	1.45	84.0	668
SFH-5160WT	SFH516032220410	\$4,742	5	224	193	168	1.60	85.0	781
SFH-5185WT	SFH518532220410	\$4,742	5	259	221	192	1.85	84.0	781
SFH-6175WT	SFH617532220410	\$5,152	6	245	212	184	1.75	85.0	901
SFH-6210WT	SFH621032220410	\$5,152	6	294	252	219	2.10	84.0	901

LESS BURNER - CHIMNEY VENTED - CAST OVER

LESS PUMP

BOILER MODEL	ITEM NUMBER	TRADE PRICE	NO. OF SEC.	INPUT (MBH)	HTG. CAP. (MBH)	AHRI NET (MBH)	FIRING RATE G.P.H.	AFUE RATING %	SHIP WGT.
SFH-3100W	SFH310020200410	\$2,508	3	140	119	103	1.00	84.0	534
SFH-4145W	SFH414520200410	\$2,958	4	203	173	150	1.45	84.0	668
SFH-5185W	SFH518520200410	\$3,470	5	259	221	192	1.85	84.0	781
SFH-6210W	SFH621020200410	\$3,870	6	294	252	219	2.10	84.0	901

TACO ECM SYSTEM PUMP

BOILER MODEL	ITEM NUMBER	TRADE PRICE	NO. OF SEC.	INPUT (MBH)	HTG. CAP. (MBH)	AHRI NET (MBH)	FIRING RATE G.P.H.	AFUE RATING %	SHIP WGT.
SFH-3100W	SFH310020240410	\$2,587	3	140	119	103	1.00	84.0	534
SFH-4145W	SFH414520240410	\$3,037	4	203	173	150	1.45	84.0	668
SFH-5185W	SFH518520240410	\$3,549	5	259	221	192	1.85	84.0	781
SFH-6210W	SFH621020240410	\$3,948	6	294	252	219	2.10	84.0	901

GRUNDFOS SYSTEM PUMP

BOILER MODEL	ITEM NUMBER	TRADE PRICE	NO. OF SEC.	INPUT (MBH)	HTG. CAP. (MBH)	AHRI NET (MBH)	FIRING RATE G.P.H.	AFUE RATING %	SHIP WGT.
SFH-3100W	SFH310020220410	\$2,587	3	140	119	103	1.00	84.0	534
SFH-4145W	SFH414520220410	\$3,037	4	203	173	150	1.45	84.0	668
SFH-5185W	SFH518520220410	\$3,549	5	259	221	192	1.85	84.0	781
SFH-6210W	SFH621020220410	\$3,948	6	294	252	219	2.10	84.0	901

LESS BURNER - CHIMNEY VENTED - WITH TANKLESS COVER PLATE

LESS PUMP

BOILER MODEL	ITEM NUMBER	TRADE PRICE	NO. OF SEC.	INPUT (MBH)	HTG. CAP. (MBH)	AHRI NET (MBH)	FIRING RATE G.P.H.	AFUE RATING %	SHIP WGT.
SFH-3100W	SFH310021200410	\$2,634	3	140	119	103	1.00	84.0	534
SFH-4145W	SFH414521200410	\$3,095	4	203	173	150	1.45	84.0	668
SFH-5185W	SFH518521200410	\$3,616	5	259	221	192	1.85	84.0	781
SFH-6210W	SFH621021200410	\$4,024	6	294	252	219	2.10	84.0	901

TACO ECM SYSTEM PUMP

BOILER MODEL	ITEM NUMBER	TRADE PRICE	NO. OF SEC.	INPUT (MBH)	HTG. CAP. (MBH)	AHRI NET (MBH)	FIRING RATE G.P.H.	AFUE RATING %	SHIP WGT.
SFH-3100W	SFH310021240410	\$2,712	3	140	119	103	1.00	84.0	534
SFH-4145W	SFH414521240410	\$3,173	4	203	173	150	1.45	84.0	668
SFH-5185W	SFH518521240410	\$3,695	5	259	221	192	1.85	84.0	781
SFH-6210W	SFH621021240410	\$4,102	6	294	252	219	2.10	84.0	901

GRUNDFOS SYSTEM PUMP

BOILER MODEL	ITEM NUMBER	TRADE PRICE	NO. OF SEC.	INPUT (MBH)	HTG. CAP. (MBH)	AHRI NET (MBH)	FIRING RATE G.P.H.	AFUE RATING %	SHIP WGT.
SFH-3100W	SFH310021220410	\$2,712	3	140	119	103	1.00	84.0	534
SFH-4145W	SFH414521220410	\$3,173	4	203	173	150	1.45	84.0	668
SFH-5185W	SFH518521220410	\$3,695	5	259	221	192	1.85	84.0	781
SFH-6210W	SFH621021220410	\$4,102	6	294	252	219	2.10	84.0	901

LESS BURNER - CHIMNEY VENTED - WITH TANKLESS COIL

LESS PUMP

BOILER MODEL	ITEM NUMBER	TRADE PRICE	NO. OF SEC.	INPUT (MBH)	HTG. CAP. (MBH)	AHRI NET (MBH)	FIRING RATE G.P.H.	AFUE RATING %	SHIP WGT.
SFH-3100WT	SFH310022200410	\$2,788	3	140	119	103	1.00	84.0	534
SFH-4145WT	SFH414522200410	\$3,293	4	203	173	150	1.45	84.0	668
SFH-5185WT	SFH518522200410	\$3,764	5	259	221	192	1.85	84.0	781
SFH-6210WT	SFH621022200410	\$4,157	6	294	252	219	2.10	84.0	901

TACO ECM SYSTEM PUMP

BOILER MODEL	ITEM NUMBER	TRADE PRICE	NO. OF SEC.	INPUT (MBH)	HTG. CAP. (MBH)	AHRI NET (MBH)	FIRING RATE G.P.H.	AFUE RATING %	SHIP WGT.
SFH-3100WT	SFH310022240410	\$2,867	3	140	119	103	1.00	84.0	534
SFH-4145WT	SFH414522240410	\$3,371	4	203	173	150	1.45	84.0	668
SFH-5185WT	SFH518522240410	\$3,842	5	259	221	192	1.85	84.0	781
SFH-6210WT	SFH621022240410	\$4,235	6	294	252	219	2.10	84.0	901

GRUNDFOS SYSTEM PUMP

BOILER MODEL	ITEM NUMBER	TRADE PRICE	NO. OF SEC.	INPUT (MBH)	HTG. CAP. (MBH)	AHRI NET (MBH)	FIRING RATE G.P.H.	AFUE RATING %	SHIP WGT.
SFH-3100WT	SFH310022220410	\$2,867	3	140	119	103	1.00	84.0	534
SFH-4145WT	SFH414522220410	\$3,371	4	203	173	150	1.45	84.0	668
SFH-5185WT	SFH518522220410	\$3,842	5	259	221	192	1.85	84.0	781
SFH-6210WT	SFH621022220410	\$4,235	6	294	252	219	2.10	84.0	901

STARFIRE SFH-IV SERIES - OPTIONS/ADD. EQUIPMENT

PN

TRADE

3085/3011 BECKETT RERATE KIT on 3 section SFH IV .85 and 1.00 Firing Rates)	(Used)	550002372	\$66
4100/4125/4145 BECKETT RERATE KIT (Used on 4 section SFH IV 1.00, 1.25, 1.45 Firing Rates)		550002373	\$66
5160/5185 BECKETT RERATE KIT on 5 section SFH IV 1.50 and 1.85 Firing Rates)	(Used)	550002374	\$66
SFH-3085/3100 BECKETT BURNER IN A BOX KIT (SFH IV 3 section boiler)		550002680	\$831
SFH-4100/4125/4145 BECKETT BURNER IN A BOX KIT (SFH IV 4 section boiler)		550002681	\$872
SFH-5150/5185 BECKETT BURNER IN A BOX KIT (SFH IV 5 section boiler)		550002682	\$886
SFH-6175/6210 BECKETT BURNER IN A BOX KIT (SFH IV 6 section boiler)		550002683	\$903
SFH 3085/3100/4100/4125/4145/5160 RIELLO 40F5 BURNER IN A BOX KIT		550002832	\$1,049
SFH 5160/5185 RIELLO 40F10 BURNER IN A BOX KIT		550002833	\$1,380
SFH 6175/6210 RIELLO 40F10 BURNER IN A BOX KIT		550002834	\$1,391
SFH 3085/3100/4100/4125/4145 CARLIN EZ1-HP BURNER IN A BOX KIT		240010414	\$815
SFH 5160/5185/6175/6210 CARLIN EZ2-HP BURNER IN A BOX KIT		240010415	\$815

STARFIRE SFH-IV SERIES - STANDARD EQUIPMENT

STANDARD EQUIPMENT:

- Boiler Controls: Hydrolevel Fuel Smart Control
- Heat Exchanger: Cast Iron Heat Exchanger with Cast Iron Push Nipples. Swing out Burner Door.
- Combustion: Oil Burner, Target Wall/Liner.
- Electrical: Wiring Harness, Burner Electrical Disconnect.
- Other: Crated Boiler, Flush Jacket, Circulator- 1½", Supply Tapping-2", Return Tapping-1 1/2", Temperature Pressure Gauge, Safety Relief Valve, Drain Valve.
- For Tankless Heater Units add Tankless Hot Water Coil and Triple Combination High Limit/Low Limit/Circulator Control

SFE IV SERIES

OIL
STEAM BOILER

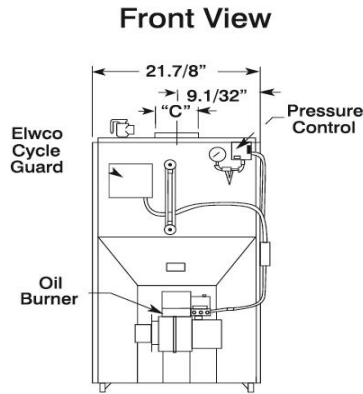
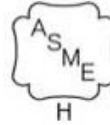

General Information (See IOM for complete instructions)

Clearances	Combustible Materials (Required) (1)	
	Top	24" (610 mm)
	Left Side (Control Side)	6" (152 mm)
	Right Side	24" (610 mm)
	Front	24" (610 mm)
	Back	24" (610 mm)
	Flue Connector	9" (229 mm)
(1) Required distances measured from boiler.		
Connections	Supply Tapping Two 2" NPT, Return Tapping 1-1/2", Oil Line 3/8" O.D. copper tubing for runs of 50 feet or less, and 1/2" O.D. for longer runs.	
Electrical	120 Volts AC, 60 hertz, 1 phase, Less than 12 amps (15 amp circuit recommended)	

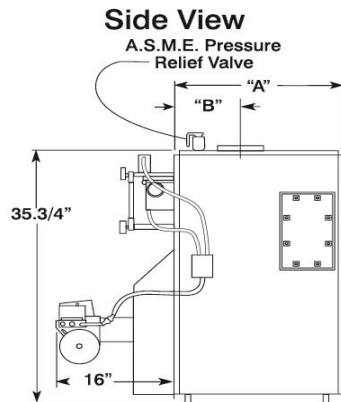

Tankless Heater Capacities

Model	Input Rate G.P.H.	Tank-less Heater Number	Tankless Heater Capacity Intermittent Draw G.P.M.	Boiler Water Content (Gallons)	
				To Water Line	To LWCO Line
SFE-3090ST	0.90	L-24	2.0	11	8
SFE-4125ST	1.25		4.5	13	9
SFE-5185ST	1.85		4.5	15	10
SFE-6210ST	2.10		4.5	15	10

Dimensions

No. of Sec.	A (Length of Flush Jacket)	B (Front of Jacket to Center Line of Flue Outlet)	C (Flue Outlet Diameter)
3	16-3/8"	6-1/2"	6"
4	20-1/4"	8-1/2"	6"
5	23-5/8"	10-1/4"	7"
6	27-1/2"	8-5/16"	8"

SFE IV SERIES CONTINUED										
(BECKETT BURNER - WITH TANKLESS COVER PLATE)										
BOILER MODEL	ITEM NUMBER	TRADE PRICE	No. of Sec.	INPUT (MBH)	HTG. CAP. (MBH)	AHRI NET (MBH)	AHRI NET SQ. FT. STEAM	Fir. Rate GPH	AFUE RATING %	SHIP WGT.
SFE-3090S	SFE309031100410	\$3,654	3	126	106	80	333	0.90	82.0%	534
SFE-4125S	SFE412531100410	\$4,219	4	175	147	110	458	1.25	82.0%	688
SFE-5185S	SFE518531100410	\$4,574	5	259	216	162	675	1.85	82.0%	781
SFE-6210S	SFE621031100410	\$5,001	6	294	247	185	771	2.10	82.0%	901
(BECKETT BURNER - WITH TANKLESS COIL)										
BOILER MODEL	ITEM NUMBER	TRADE PRICE	No. of Sec.	INPUT (MBH)	HTG. CAP. (MBH)	AHRI NET (MBH)	AHRI NET SQ. FT. STEAM	Fir. Rate GPH	AFUE RATING %	SHIP WGT.
SFE-3090ST	SFE309032100410	\$4,093	3	126	106	80	333	0.90	82.0%	534
SFE-4125ST	SFE412532100410	\$4,658	4	175	147	110	458	1.25	82.0%	688
SFE-5185ST	SFE518532100410	\$5,013	5	259	216	162	675	1.85	82.0%	781
SFE-6210ST	SFE621032100410	\$5,438	6	294	247	185	771	2.10	82.0%	901
SFE IV SERIES - STANDARD EQUIPMENT										
<u>STANDARD EQUIPMENT:</u>										
<ul style="list-style-type: none"> - Boiler Controls: Honeywell Pressuretrol, Boiler Water Level Gauge Glass, and Steam Pressure Gauge. - Heat Exchanger: Cast Iron Heat Exchanger with Cast Iron Push Nipples, Swing Door. - Combustion: Beckett Oil Burner, Target Wall/Liner. - Electrical: Wiring Harness, Burner Electric Disconnect. - Safety: Electronic Low Water Cut Off. - Other: Crated Boiler, Flush Jacket, ASME Relief Valve, Drain Valve, Plastic Cover, Two 2" Supply Tappings, 1-1/2" Return Tapping and Skim Port. - For Tankless Heater Units: Add Tankless Hot Water Coil and 4006 Limit Control. 										

BC SERIES II
OIL
WATER BOILER

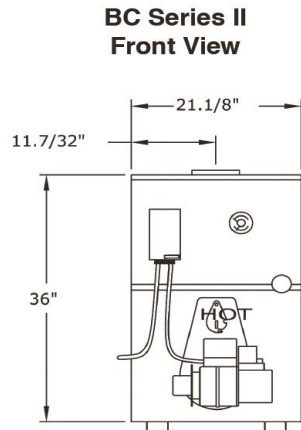

BC Series II Side View

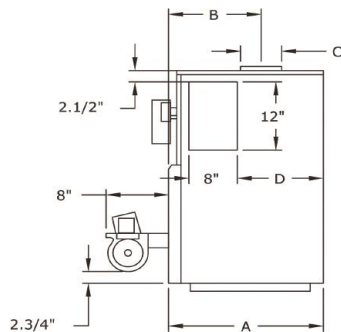

General Information (See IOM for complete instructions)

Clearances		Combustible Materials (Required) (1)
(1) Required distances measured from boiler.	Top	24" (610 mm)
	Front	24" (610 mm)
	Flue Connector	9" (229 mm)
	Rear	6" (152 mm)
	Left Side	6" (152 mm)
	Right Side	24" (610 mm)
Connections (All Models)	Return/Supply Tappings 1-1/4" NPT, Oil Line 3/8" O.D. copper tubing for runs of 50 feet or less, and 1/2" O.D. for longer runs.	
Electrical	120 Volts AC, 60 hertz, 1 phase, Less than 12 amps (15 amp circuit recommended)	

Tankless Heater Capacities

Model	Input Rate G.P.H.	Tankless Heater Number	Tankless Heater Capacity Intermittent Draw G.P.M.	Boiler Water Content (Gallons)
BC3095	0.95	L-24	3.25	6.7
BC4100	1.00		3.25	8.2
BC4115	1.15		4.0	8.2

Dimensions

Model	A (Length of Flush Jacket)	B (Front of Jacket to Center Line of Flue Outlet)	C (Flue Outlet Diameter)	D (Tankless Coil to Back of Jacket)
BC3095	19"	9-3/4"	6"	8-7/8"
BC4100	23"	11-3/4"	6"	12-3/4"
BC4115	23"	11-3/4"	6"	12-3/4"

BC SERIES II CONTINUED										
(BECKETT BURNER - CHIMNEY VENTED - WITH COIL - LESS PUMP)										
BOILER MODEL	ITEM NUMBER	TRADE PRICE	FIR. RATE	INPUT (MBH)	HTG. CAP. (MBH)	AHRI NET (MBH)	AFUE RATING %	CHIMNEY SIZE	FLUE DIA.	SHIP WGT.
BC3095	BCB309532100210	\$2,892	0.95	133	114	99	84.0	8"x 8"x15'	6"	345
BC4100	BCB410032100210	\$3,217	1.00	140	121	105	85.0		6"	404
(BECKETT BURNER - CHIMNEY VENTED - WITH COIL - WITH TACO ECM SYSTEM PUMP)										
BOILER MODEL	ITEM NUMBER	TRADE PRICE	FIR. RATE	INPUT (MBH)	HTG. CAP. (MBH)	AHRI NET (MBH)	AFUE RATING %	CHIMNEY SIZE	FLUE DIA.	SHIP WGT.
BC3095	BCB309532140210	\$2,970	0.95	133	114	99	84.0	8"x 8"x15'	6"	345
BC4100	BCB410032140210	\$3,297	1.00	140	121	105	85.0		6"	404
BC4115	BCB411532140210	\$3,297	1.15	161	137	119	84.0		6"	404
(BECKETT BURNER - CHIMNEY VENTED - WITH COIL - WITH GRUNDFOS SYSTEM PUMP)										
BOILER MODEL	ITEM NUMBER	TRADE PRICE	FIR. RATE	INPUT (MBH)	HTG. CAP. (MBH)	AHRI NET (MBH)	AFUE RATING %	CHIMNEY SIZE	FLUE DIA.	SHIP WGT.
BC3095	BCB309532120210	\$2,970	0.95	133	114	99	84.0	8"x 8"x15'	6"	345
BC4100	BCB410032120210	\$3,297	1.00	140	121	105	85.0		6"	404
(BECKETT BURNER - CHIMNEY VENTED - LESS COIL - LESS PUMP)										
BOILER MODEL	ITEM NUMBER	TRADE PRICE	FIR. RATE	INPUT (MBH)	HTG. CAP. (MBH)	AHRI NET (MBH)	AFUE RATING %	CHIMNEY SIZE	FLUE DIA.	SHIP WGT.
BC3095	BCB309531100210	\$2,628	0.95	133	114	99	84.0	8"x 8"x15'	6"	345
BC4100	BCB410031100210	\$2,951	1.00	140	121	105	85.0		6"	404
(BECKETT BURNER - CHIMNEY VENTED - LESS COIL - WITH TACO ECM SYSTEM PUMP)										
BOILER MODEL	ITEM NUMBER	TRADE PRICE	FIR. RATE	INPUT (MBH)	HTG. CAP. (MBH)	AHRI NET (MBH)	AFUE RATING %	CHIMNEY SIZE	FLUE DIA.	SHIP WGT.
BC3095	BCB309531140210	\$2,707	0.95	133	114	99	84.0	8"x 8"x15'	6"	345
BC4100	BCB410031140210	\$3,029	1.00	140	121	105	85.0		6"	404
BC4115	BCB411531140210	\$3,029	1.15	161	137	119	84.0		6"	404
(BECKETT BURNER - CHIMNEY VENTED - LESS COIL - WITH GRUNDFOS SYSTEM PUMP)										
BOILER MODEL	ITEM NUMBER	TRADE PRICE	FIR. RATE	INPUT (MBH)	HTG. CAP. (MBH)	AHRI NET (MBH)	AFUE RATING %	CHIMNEY SIZE	FLUE DIA.	SHIP WGT.
BC3095	BCB309531120210	\$2,707	0.95	133	114	99	84.0	8"x 8"x15'	6"	345
BC4100	BCB410031120210	\$3,029	1.00	140	121	105	85.0		6"	404
(USE PARTS MULTIPLIER FOR ALL OF THE FOLLOWING)							PN	TRADE		
BC4100 RERATE KIT - BC4115 to 1.00 GPH							550002656	\$41		
BC4115 RERATE KIT - BC4100 to 1.15 GPH							550002657	\$33		
BC SERIES II - STANDARD EQUIPMENT										
<u>STANDARD EQUIPMENT:</u>										
- Boiler Controls: High Limit, Circulator Control and Primary Control.										
- Heat Exchanger: Cast Iron Heat Exchanger with Cast Iron Push Nipples.										
- Combustion: Beckett Oil Burner, Combustion Chamber with Target Wall/Liner.										
- Electrical: Wiring Harness, Burner Electrical Disconnect.										
- Safety: 30 PSI A.S.M.E. Safety Relief Valve.										
- Other: Crated Cast Iron Boiler with Insulated Flush Jacket; Circulator - 1-1/4", Temperature Pressure Gauge, Boiler Drain Valve, 1-1/4" Supply and Return Tapping.										
- For Tankless Heater Units: Tankless Hot Water Coil and Low Limit.										

H2O SERIES
STAINLESS STEEL
SINGLE COIL
INDIRECT WATER HEATER

H2O I 40 L UB

I=Indirect
 Capacity: 30=30 Gals. L=Lowboy
 40=40 Gals. C=Commercial
 50=50 Gals. HO=High Output
 60=60 Gals. HOC=High Output
 80=80 Gals. XHO=Extra High
 85=87 Gals. Commercial
 115=115 Gals. Output
 UB=Utica Boiler



Conforms to UL STD 174
 Certified to CAN/CSA STD C22.2 No. 110-94

STANDARD AND HO UNITS

HOC UNITS

XHOC EXTRA HIGH OUTPUT UNITS

Note: Max. Working pressure 150 psi for all capacities.

General Information (See IOM for complete instructions)

Model	Piping Connections NPT		Height (Inches)	Dia. (Inches)
	Domestic Water In/Out (Inches)	Boiler Water In/Out (Inches)		
H2O130UB	3/4	1	34.0	23.5
H2O140UB	3/4	1	44.0	23.5
H2O140LUB	3/4	1	36.0	28.0
H2O150UB	3/4	1	54.0	23.5
H2O160UB	3/4	1	62.0	23.5
H2O160LUB	3/4	1	46.0	28.0
H2O180UB	1	1	56.0	28.0
H2O1115UB	1	1	74.0	28.0
H2O160HOUB	1	1	62.0	23.5
H2O180HOUB	1	1	56.0	28.0
H2O180HOCUB	1-1/2	1-1/4	56.0	28.0
H2O1115HOUB	1	1	74.0	28.0
H2O1115HOCUB	1-1/2	1-1/4	74.0	28.0
H2O185XHOCUB	1-1/2	1-1/2	64.0	28.0
H2O1115XHOCUB	1-1/2	1-1/2	74.0	28.0

H2O SINGLE COIL STAINLESS STEEL INDIRECT WATER HEATERS CONTINUED

MODEL	TRADE PRICE	STOR. CAP. (Gals.)	DESCRIPTION	MAX. FIRST HOUR RATING Gal./Hr. @		BOILER OUTPUT REQ. (BTU/Hr.)	SHP. WGT. (LBS.)
				140°F	115°F		
H2OI30UB	\$1,431	30	STANDARD	202	269	131,250	85
H2OI40UB	\$1,472	40	STANDARD	221	292	138,670	100
H2OI40LUB	\$1,568	42	LOWBOY	212	251	132,000	100
H2OI50UB	\$1,777	50	STANDARD	223	291	133,280	110
H2OI60UB	\$2,125	60	STANDARD	262	342	155,700	125
H2OI60LUB	\$2,186	60	LOWBOY	239	310	138,570	120
H2OI80UB	\$2,357	80	STANDARD	271	248	149,390	140
H2OI115UB	\$3,497	115	STANDARD	324	409	165,750	175
H2OI60HOUB	\$2,292	60	HIGH OUTPUT	406	541	263,600	145
H2OI80HOUB	\$3,186	80	HIGH OUTPUT	418	551	259,640	155
H2OI80HOCUB	\$3,438	80	HIGH OUTPUT COMMERCIAL	442	584	227,070	155
H2OI115HOUB	\$4,308	115	HIGH OUTPUT	467	607	273,100	190
H2OI115HOCUB	\$4,562	115	HIGH OUTPUT COMMERCIAL	479	623	281,300	190
H2OI85XHOCUB	\$4,282	87	EXTRA HIGH OUTPUT	738	992	495,000	215
H2OI115XHOCUB	\$5,082	115	EXTRA HIGH OUTPUT	763	1017	495,000	240

H2O SINGLE COIL INDIRECT WATER HEATERS WITH ELECTRIC BACKUP (3500 WATTS)

MODEL	TRADE PRICE	STOR. CAP. (Gals.)	DESCRIPTION	MAX. FIRST HOUR RATING Gal./Hr. @		SHP. WGT. (LBS.)
				140°F	115°F	
H2OI60EUB	\$2,984	60	ELECTRIC BACK-UP	254	333.0	135
H2OI80EUB	\$3,338	80	ELECTRIC BACK-UP	266	341.0	145
H2OI115EUB	\$4,627	115	ELECTRIC BACK-UP	319	403.0	180

H2O SINGLE COIL STANDARD EQUIPMENT

Standard Equipment: Factory installed brass drain and relief valves, welded stainless steel cold water dip tube factory installed and pressure tested, Honeywell L4080B aquastat for field installation and magnesium anode rod(s).

H2O SINGLE COIL OPTIONS

Options: (L) Low Profile, (C) Commercial, (HO) High Output, (HOC) High Output Commercial, (XHO) Extra High Output, (E) Electric Backup

H2O SERIES
STAINLESS STEEL
DUAL COIL SOLAR
INDIRECT WATER HEATER



H2O

I

60

D

E

UB

I = Indirect

Capacity:
 60 = 60 Gals.
 80 = 80 Gals.
 115 = 115 Gals.

D = Dual Coil

E = Electrical
 Back up
 (3500 Watts)

UB = Ultra Boiler

Conforms to UL STD 174

Intertek

Certified to CAN/CSA STD C22.2 No. 110-94

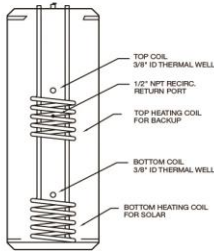
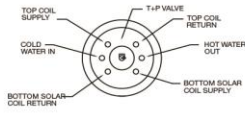

DUAL COIL UNITS

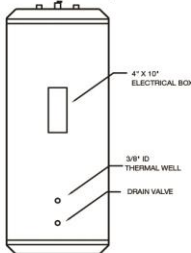
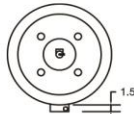

ELECTRIC BACKUP UNITS



Note: Max. Working pressure 150 psi for all capacities.

General Information (See IOM for complete instructions)

Model	Piping Connections NPT (Inches)	Height (Inches)	Dia. (Inches)
H2O160DUB	1	62.0	23.5
H2O180DUB	1	56.0	28.0
H2O115DUB	1	74.0	28.0
H2O160DEUB	1	62.0	23.5
H2O180DEUB	1	56.0	28.0
H2O115DEUB	1	74.0	28.0

H2O DUAL COIL STAINLESS STEEL INDIRECT WATER HEATERS CONTINUED

MODEL	TRADE PRICE	STOR. CAP. (Gals.)	DESCRIPTION	RECOVERY RATE GAL./HR.		SHP. WGT. (LBS.)
				TOP COIL	BOTTOM COIL	
H2OI60DUB	\$2,820	60	DUAL COIL INDIRECT	185	214	165
H2OI80DUB	\$3,211	80	DUAL COIL INDIRECT	180	214	175
H2OI115DUB	\$4,113	115	DUAL COIL INDIRECT	190	214	205

H2O DUAL COIL STAINLESS STEEL INDIRECT WATER HEATERS WITH ELECTRIC BACKUP (3500 WATTS)

MODEL	TRADE PRICE	STOR. CAP. (Gals.)	DESCRIPTION	RECOVERY RATE GAL./HR.		SHP. WGT. (LBS.)
				TOP COIL	BOTTOM COIL	
H2OI60DEUB	\$3,482	60	DUAL COIL ELECTRIC BACK-UP	185	214	175
H2OI80DEUB	\$3,935	80	DUAL COIL ELECTRIC BACK-UP	180	214	185
H2OI115DEUB	\$4,936	115	DUAL COIL ELECTRIC BACK-UP	190	214	215

H2O DUAL COIL STANDARD EQUIPMENT

Standard Equipment: Factory installed brass drain and relief valves, welded stainless steel cold water dip tube factory installed and pressure tested, Honeywell L4080B aquastat for field installation and magnesium anode rod(s). Removable thermal well to accept a solar control thermostat or thermistor. Dual coil units equipped with two aquastat wells which control each coil independently and built-in recirculation tapping. Units with Electric Back-Up are provided with 4" x 10" electrical box with pre-wired heating element, thermostat, and hi-limit. All electric back-up units provided with 240 volt AC, 3500 watt element.

H2O DUAL COIL OPTIONS

Options: (E) Electric Backup models for supplemental heating.

H2O SERIES
STAINLESS STEEL
STORAGE TANKS



H2O ST 60 L UB

ST = Storage Tank

Capacity:
30 = 30 Gals.
40 = 40 Gals.
60 = 60 Gals.
80 = 80 Gals.
115 = 115 Gals.

L = Lowboy
C = Commercial

UB = Utica Boiler

Intertek Conforms to UL STD 174
Certified to CAN/CSA STD C22.2 No. 110-94

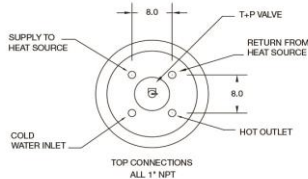

STANDARD UNITS

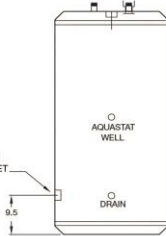
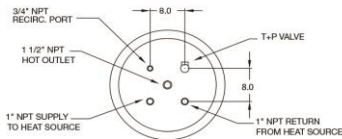

COMMERCIAL UNITS



Note: Max. Working pressure 150 psi for all capacities.

General Information (See IOM for complete instructions)

Model	Piping Connections NPT		Height (Inches)	Dia. (Inches)
	Supply/Return (Inches)	Heat Source Pressure (Inches)		
H2OST30UB	1	1	34.0	23.5
H2OST40UB	1	1	44.0	23.5
H2OST60UB	1	1	62.0	23.5
H2OST60LUB	1	1	46.0	23.5
H2OST80UB	1	1	56.0	28.0
H2OST115UB	1	1	74.0	28.0
H2OST80CUB	1-1/2	1	56.0	28.0
H2OST115CUB	1-1/2	1	74.0	28.0

H2O STAINLESS STEEL HOT WATER STORAGE TANKS (NO COIL) CONTINUED

MODEL	TRADE PRICE	STOR. CAP. (Gals.)	DESCRIPTION	SHP. WGT. (LBS.)
H2OST30UB	\$1,270	30	H2O HOT WATER STORAGE TANK (NO COIL)	75
H2OST40UB	\$1,313	40	H2O HOT WATER STORAGE TANK (NO COIL)	90
H2OST60UB	\$1,914	60	H2O HOT WATER STORAGE TANK (NO COIL)	115
H2OST60LUB	\$1,977	60	LOW BOY H2O HOT WATER STORAGE TANKS (NO COIL)	110
H2OST80UB	\$2,175	80	H2O HOT WATER STORAGE TANKS (NO COIL)	140
H2OST80CUB	\$3,133	80	COMM. H2O HOT WATER STORAGE TANK (NO COIL)	175
H2OST115UB	\$2,393	115	H2O HOT WATER STORAGE TANK (NO COIL)	140
H2OST115CUB	\$3,352	115	COMM. H2O HOT WATER STORAGE TANK (NO COIL)	175
H2O STORAGE TANK STANDARD EQUIPMENT				
<u>Standard Equipment:</u> Factory installed brass drain and relief valves, welded stainless steel cold water dip tube factory installed and pressure tested, Honeywell L4080B aquastat for field installation.				
H2O STORAGE TANK OPTIONS				
<u>Options:</u> (C) Commercial, (L) Low Profile				

H2O SERIES
STAINLESS STEEL
BUFFER TANKS

H2O BT 40 114 WC UB

BT=Buffer Tank

Capacity:
22=22 Gals.
40=40 Gals.
60=60 Gals.
80=80 Gals.

114=1-1/4" NPT
112=1-1/2" NPT
2=2" NPT

WC=With Coil

UB=Utica Boiler



Conforms to UL STD 174
Certified to CAN/CSA STD C22.2 No. 110-94

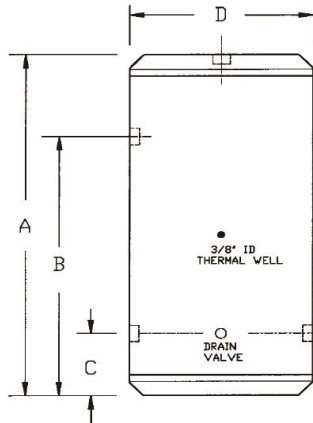

4 CONNECTIONS
1 ON RIGHT SIDE
2 ON LEFT SIDE
1 ON TOP



Note: Max. Working pressure 150 psi for all capacities.

General Information (See IOM for complete instructions)

Model	Piping Connections NPT (Inches)	Height (Inches)	B (Inches)	C (Inches)
H2OBT22114UB	1-1/4	24.5	15	8
H2OBT40114UB	1-1/4	42.0	31.0	11.0
H2OBT40112UB	1-1/2			
H2OBT402UB	2			
H2OBT60114UB	1-1/4	44.0	31.5	11.5
H2OBT60112UB	1-1/2			
H2OBT602UB	2			
H2OBT80114UB	1-1/4	54	40.5	11.5
H2OBT80112UB	1-1/2			
H2OBT802UB	2			
H2OBT115114UB	1-1/4	72	61.5	11.5
H2OBT115112UB	1-1/2			
H2OBT1152UB	2			
H2OBT40114WCUB	1-1/4	42.0	31.0	11.0
H2OBT40112WCUB	1-1/2			
H2OBT402WCUB	2			
H2OBT60114WCUB	1-1/4	44.0	31.5	11.5
H2OBT60112WCUB	1-1/2			
H2OBT602WCUB	2			
H2OBT80114WCUB	1-1/4	54	40.5	11.5
H2OBT80112WCUB	1-1/2			
H2OBT802WCUB	2			
H2OBT115114WCUB	1-1/4	72	61.5	11.5
H2OBT115112WCUB	1-1/2			
H2OBT1152WCUB	2			

H2O HYDRONIC STAINLESS STEEL BUFFER TANKS CONTINUED

MODEL	TRADE PRICE	STOR. CAP. (Gals.)	DESCRIPTION	SHP. WGT. (LBS.)
H2OBT22114UB	\$1,273	22	HYDRONIC BUFFER TANK	35
H2OBT40114UB	\$2,227	40	HYDRONIC BUFFER TANK	87
H2OBT40112UB	\$2,227			
H2OBT402UB	\$2,227			
H2OBT60114UB	\$2,652	60	HYDRONIC BUFFER TANK	115
H2OBT60112UB	\$2,652			
H2OBT602UB	\$2,652			
H2OBT80114UB	\$2,927	80	HYDRONIC BUFFER TANK	125
H2OBT80112UB	\$2,927			
H2OBT802UB	\$2,927			
H2OBT115114UB	\$3,645	115	HYDRONIC BUFFER TANK	160
H2OBT115112UB	\$3,645			
H2OBT1152UB	\$3,645			

H2O HYDRONIC BUFFER TANKS (WITH COIL)

MODEL	TRADE PRICE	STOR. CAP. (Gals.)	DESCRIPTION	SHP. WGT. (LBS.)
H2OBT40114WCUB	\$2,855	40	HYDRONIC BUFFER TANK (WITH COIL)	97
H2OBT40112WCUB	\$2,856			
H2OBT402WCUB	\$2,855			
H2OBT60114WCUB	\$3,321	60	HYDRONIC BUFFER TANK (WITH COIL)	125
H2OBT60112WCUB	\$3,321			
H2OBT602WCUB	\$3,321			
H2OBT80114WCUB	\$3,621	80	HYDRONIC BUFFER TANK (WITH COIL)	135
H2OBT80112WCUB	\$3,621			
H2OBT802WCUB	\$3,621			
H2OBT115114WCUB	\$4,408	115	HYDRONIC BUFFER TANK (WITH COIL)	170
H2OBT115112WCUB	\$4,408			
H2OBT1152WCUB	\$4,408			

H2O BUFFER TANK STANDARD EQUIPMENT

Standard Equipment: Factory installed brass drain and relief valves, welded stainless steel cold water dip tube factory installed and pressure tested, Honeywell L4080B aquastat for field installation.

H2O BUFFER TANK OPTIONS

Options: (WC) With Coil

HOTLINE SERIES
INDIRECT WATER HEATER

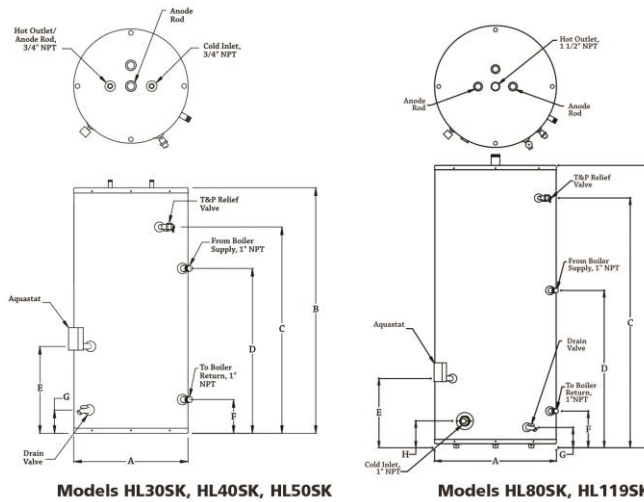

Note: Max. Working pressure 150 psi for all capacities.

General Information (See IOM for complete instructions)

Model	Piping Connections NPT		A Dia. (Inches)	B Height (Inches)
	Domestic Water In/Out (Inches)	Boiler Water In/Out (Inches)		
*ST00211	3/4	1	22.0	35-3/4
ST00215	3/4	1	22.0	42-3/4
ST00212	3/4	1	22.0	48-3/4
ST00213	1	1	24.0	64-3/4
ST00214	1	1	28.0	65-1/4

HOTLINE INDIRECT WATER HEATERS

MODEL	NAME	TRADE PRICE	STOR. CAP. (Gals.)	BTU/H MIN. BOILER OUTPUT	MAX 1ST HR FLOW RATINGS GAL./HR.	SHP. WGT. (LBS.)
*ST00211	HL30SK	\$1,270	30	74	115	140
ST00215	HL40SK	\$1,400	40	74	125	200
ST00212	HL50SK	\$1,541	50	74	140	220
ST00213	HL80SK	\$2,198	80	150	185	286
ST00214	HL119SK	\$2,693	119	175	250	372

*SURFACE MOUNTED THERMOSTAT.

HOTLINE OPTIONS/ADDITIONAL EQUIPMENT

	PN	TRADE
MAGNESIUM ANODE 3/4 X 30; 30-40-50 GAL.	ST00301	\$64
MAGNESIUM ANODE 3/4 X 36; 80 GAL.	ST00701	\$52
MAGNESIUM ANODE 3/4 X 36; 119 GAL.	ST00901	\$71
DIP TUBE 3/4 X 3 X 33; 30 GAL.	ST00401	\$73
DIP TUBE 3/4 X 3 X 38; 40 GAL.	ST01301	\$16
DIP TUBE 3/4 X 3 X 44; 50 GAL.	ST00801	\$32
T & P VALVE 3/4, LL100XL; 30-40-50 GAL.	ST00601	\$38
T & P VALVE 3/4, 140X5; 80-119 GAL.	ST01001	\$92
AQUASTAT L4080B1352	ST01101	\$330

HOTLINE INDIRECT WATER HEATER STANDARD EQUIPMENT

STANDARD EQUIPMENT: Factory Assembled Hot Water Tank; Steel Tank with 2" Foam Insulation; Smooth Coil Coated with Porcelain to resist Corrosion and Lime Build-Up; Replaceable Magnesium Anode Rod Aquastat Limit Control; Self Cleaning Drain Valve; Factory Installed T & P Valve.